



**20
26**
CATALOG



Yüksek Kalitenin Güvenini Yaşayın
Experience The Confidence Of High Quality



Hakkımızda

IRTU Grup olarak, 1995 yılından beri faaliyet gösterdiğimiz Alçak ve Orta Gerilim Elektrik sektöründe kaliteden ödün vermeden çözüm odaklı bir firma olarak, sektörün ihtiyaç duyduğu ürünleri üreterek dünya çapında tercih edilebilecek standartlarda faaliyetlerimize devam ediyoruz.

Bu vizyon doğrultusunda, ilk uzmanlık alanımız olan Cam Elyaf Takviyeli Polyester (BMC), Alev Geciktirici (V0) plastik izolatörler ve Polyester Levha (UPGM 203 Cam Elyaf Levha) ürün gruplarına ek olarak, taşıyıcı şalt barlarını desteklemek için kullanılan pirinç topraklama terminalleri, dağıtım üniteleri, bakır topraklama şalt barları ve her zaman gerekebilecek birçok tüketim malzemesini kendi yapımız içerisinde üretiyoruz.

IRTU Grubu olarak, kalite ve hızlı hizmet anlayışımızı CE Belgesi, ISO 9001 Kalite Yönetim Standartları Belgesi gibi kabul edilen standartlarla belgelendirirken, ürün bazında gerekli test belgeleriyle güçlendiriyoruz.

INDEX

| | | | |
|-------|--|---|---------|
| 2-5 | PLASTİK MESNET İZOLATÖRLER PLASTIC INDOOR TYPE INSULATORS | SİNYAL VE BUTON GRUPLARI SIGNAL AND BUTTON GROUPS | 58 |
| 6-15 | PLASTİK TARAK İZOLATÖRLER PLASTIC BUSBAR SUPPORT INSULATORS | PANO PİRİZLERİ PANEL SOCKET | 59 |
| 16 | PLASTİK GEÇİŞ İZOLATÖRLERİ PLASTIC TRANSITION INSULATORS | PANO ETİKETLERİ PANEL LABELS | 60 |
| 17 | BAĞLANTI APARATLARI CONNECTION EQUIPMENTS | OTOMAT ETİKETLERİ VE KAPATMALARI AUTOMAT LABEL AND COVER PLATES | 61 |
| 18-23 | POLYESTER MESNET İZOLATÖRLER POLYESTER INDOOR TYPE INSULATORS | PVC VE SAC UYARI ETİKETLERİ PVC AND SHEET METAL ATTANTION LABELS | 62 |
| 24-28 | POLYESTER TARAK İZOLATÖRLER POLYESTER BUSBAR SUPPORT INSULATORS | BORU VE KABLO TAŞIMA APARATLARI PIPE AND CABLE TRANSPORT EQUIPMENTS | 63 |
| 29-30 | UPGM EL YATIRMA CAM ELYAF PLAKALAR UPGM HAND LAY UP FIBER GLASS PLATES | KÖR TAPALAR BLINDSTOP | 64 |
| 31 | UPGM SMC CAM ELYAF PLAKALAR UPGM 203 SMC FIBER GLASS PLATES | PROJE CEBİ VE HAVLANDIRMALAR PROJECT PACK POCKET AND AIR CONDITIONINGS | 65 |
| 34 | O.GERİLİM MESNET İZOLATÖRLER M. VOLTAGE INDOOR TYPE INSULATORS | PANO SAC AKSESUARLARI PANEL SHEET ACCESSORIES | 66 |
| 35 | TRAFO BUSHING İZOLATÖRLER TRANSFORMER BUSHING INSULATORS | İZOLELİ YÜKSÜKLER INSULATED CORN AND TERMINALS | 68-69 |
| 36 | O.GERİLİM KABLO TUTUCU VE KÖRÜKLER VOLTAGE CABLE HOLDER AND BELLOWS | KABLO PAPUÇLARI CABLE LUGS | 70-81 |
| 38-42 | DAĞITICI ÜNİTELER DISTRIBUTION UNITS | KABLO KANALLARI CABLE TRUNKINGS | 82 |
| 43 | İZOLASYONLU TOPRAKLAMA KLEMENSLERİ INSULATED PANEL GROUNDING TERMINALS | KABLO TOPLAYICILAR CABLE COLLECTORS | 83 |
| 44-47 | İZOLE VE TOPRAKLAMA KLEMENSLER INSULATED AND GROUNDING TERMINALS | ISI İLE DARALAN MAKARONLAR HEAT SHRINK MACARON | 84 -85 |
| 48 | TOPRAKLAMA BARALARI EARTING BARS | PANO İZOLASYON EKİPMANLARI PANEL INSULATED EQUIPMENT | 86 - 87 |
| 49 | GÜÇ DAĞITIM BARASI POWER DISTRIBUTION BUSBAR | KABLO BAĞLARI VE KROŞELER CABLE TIES AND CROCHES | 88-89 |
| 50 | BAKIR BAĞLANTI ve U KLEMENSLERİ COPPER CONNECTION AND U TERMINALS | MONTAJ RAYLARI PANEL MOUNTING RAIL | 90 |
| 51 | FLEXİ BAĞLATI BARALARI FLEXI CONNECTION BUS BARS | SİLİKON MAKARON, CONTA VE SİRİAL SILICON HEAT SHRINK, GASKET AND COLLECT SPIRAL | 91 |
| 52-54 | MÜŞTEREK W OTOMAT BARALARI JOIN W VENDING BUS BARS | SIRA VE SOKET KLEMENSLER TERMINAL STRITS AND SOCKET CONNECTORS | 92-94 |
| 56-57 | LED AYDINLATMALAR LED LIGHTINGS | TRAFO VE STEATİT KLEMENSLER TRANSFORMER AND STEATİT TERMINALS | 95 |
| | | RAKOR, SOMUN VE KÖR TAPALAR BRASS CABLE GLAND, NUTS AND BLINDSTOPS | 96-97 |
| | | SİRİAL BORULAR VE ROKARLARI SPIRAL CONDUIT ADN GLAND | 98-100 |
| | | AKİM TRAFOLARI CURRENT TRANSFORMERS | 102-105 |
| | | SİLİNDİRİK SİGORTA YUVA VE KARTUŞLARI CYLINDRICAL FUSE AND CARTRIDGES | 106 |

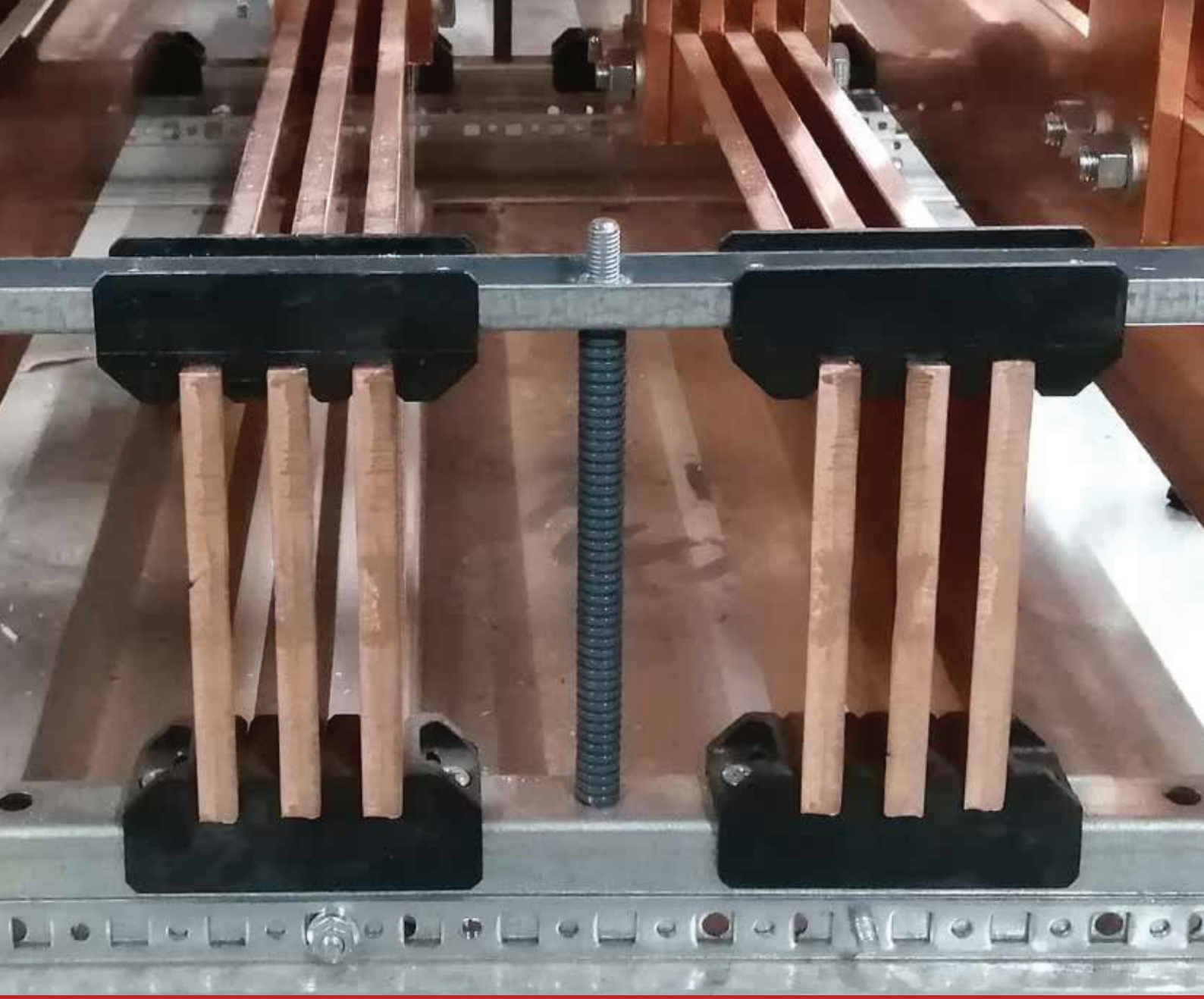

PLASTİK (V0) İZOLATÖRLER

PLASTIC (V0) INSULATORS

Alçak gerilim plastik izolatörleri alev almaz (V0) malzemedendir. BMC izolatörler ile aynı amaç için kullanılır. Düşük kırılma oranı nedeniyle BMC izolatörlere göre daha esnektir.

Low voltage plastic insulators are made of inflammable material. They are used for the same purpose with BMC insulators. Due to their low breaking ratio they are more flexible compare to BMC insulators.

PLASTİK (V0) İZOLATÖRLER



Yanmaz (V0) malzemeden imal edilmiştir. Polyester izolatörler ile aynı amaç için kullanılır, BMC malzemeye göre daha esnek olmasından dolayı kırılma oranı düşüktür. Kimyasal özellikleri aşağıdaki gibidir;

- Cam elyaf takviyeli yanmaz plastik (PA6), %30 elyaf ihtiva eder.
- Standart renk: Siyah
- Körsomunlar: Çelik çinko kaplamalı (istek üzerine pirinç malzeme)
- Cıvata: cr3 8.8 çelik cıvata

Low tension post insulators is made of non-flammable (V0) material. It is used for the same purpose as BMC insulators. It is more flexible than BMC insulators due to refraction rate is low. It's chemical characters are listed below:

- *Fiber Glass reinforced poliamid (PA6) nonflamable, has 30% of fibers.*
- *Standart color: Black*
- *Nuts: Steel-zinc line. (Brass material can used if needed)*
- *Bolts: Cr3 8.8 steel bolt*

| | | | | |
|--|---|---|--|---|
| Uygun Çalışma Sıcaklığı <i>Application</i> | Genel elektroteknik uygulaması Sıcaklık aralığı | <i>General electrotechnical application.</i> <i>Temperature range</i> | -40 °C to +130 °C | |
| Fiziksel Özellikler <i>Pyhsical Properties</i> | Cam elyaf oranı Özkütle Kalıp çekmesi Su emme | <i>Glassfibre Contents</i> <i>Specific Weight</i> <i>Moulding Shrinkage</i> <i>Water Absorption</i> | 30% 1,56g/cm ³ <0,03% <0,2% (<25mg) | DIN EN ISO 62 |
| Mekanik Özellikler <i>Mechanical Properties</i> | Martens derecesi Bükülme dayanıklılığı Darbe dayanıklılığı | <i>Martens Degree</i> <i>Flexural Strength</i> <i>Impact Strength</i> | >200°C 205 N/mm ² 14 kJ/m ² | DIN 53462 DIN EN ISO 178 DIN EN ISO 180 |
| Elektriksel Özellikler <i>Electrical Properties</i> | Yüzel direnci Elektrik öz direnci Dielectric dayanımı Alev alma dayanımı | <i>Surface Resistivity</i> <i>Volume Resistivity</i> <i>Dielectric Strength</i> <i>Tracking Resistance</i> | 10 ¹⁴ Ωcm 10 ¹⁴ Ωcm 150 kV/cm CTI 600 | DIN IEC 60093 DIN IEC 60093 DIN EN 60243-1 DIN IEC 60112 |
| Yanmazlık <i>Flammability</i> | Kızaran tel testi | <i>Glow -wire Flammability</i> | 960° C | DIN EN 60695 |

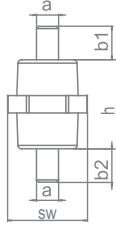
 960°C
 30s

Çift taraf Saplmalı / Busbar Standoff Insulators With Double Side Screw

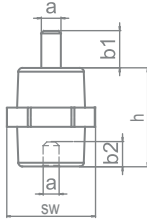
| Kod / Code | Tıp / Type | Ölçüler / Dimensions (mm) | | | | | Kullanım Voltajı ~ kV | Test Voltajı ~ kV | Gerilim Direnci kN | Ağırlık kg/1 box | Kutu Adedi / Box Qty. | Birim Fiyat Price (Adet/pcs) |
|---------------|------------|---------------------------|----|----|------|------|-----------------------|-------------------|--------------------|------------------|-----------------------|------------------------------|
| | | a1 | b1 | b2 | SW | h | | | | | | |
| IRTU-PLSM1001 | M5 | 5 | 12 | 12 | 18 | 25,5 | 0,6 | 3 | 1,00 | 8,50 | 500 | 57,00 TL |
| IRTU-PLSM1002 | M6 | 6 | 16 | 16 | 21 | 29,5 | 0,6 | 3 | 1,00 | 8,70 | 300 | 70,00 TL |
| IRTU-PLSM1003 | M8 | 8 | 15 | 15 | 31,5 | 40 | 1 | 3 | 4,00 | 7,10 | 100 | 124,00 TL |
| IRTU-PLSM1004 | M10 | 10 | 15 | 15 | 31,5 | 40 | 1 | 3 | 4,00 | 9,50 | 100 | 150,60 TL |
| IRTU-PLSM1013 | M8 | 8 | 18 | 18 | 43,3 | 50 | 1 | 3 | 4,00 | 9,50 | 100 | 247,30 TL |
| IRTU-PLSM1014 | M10 | 10 | 18 | 18 | 43,3 | 50 | 1 | 3 | 4,00 | 9,50 | 100 | 274,90 TL |

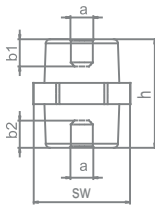

 960°C
 30s

Saplama & Kör Somunlu / Busbar Standoff insulators with One Side Screw

| Kod / Code | Tıp / Type | Ölçüler / Dimensions(mm) | | | | | Kullanım Voltajı ~ kV | Test Voltajı ~ kV | Gerilim Direnci kN | Ağırlık kg/1 box | Kutu Adedi / Box Qty. | Birim Fiyat Price (Adet/pcs) |
|---------------|------------|--------------------------|------|----|------|------|-----------------------|-------------------|--------------------|------------------|-----------------------|------------------------------|
| | | a1 | b1 | b2 | SW | h | | | | | | |
| IRTU-PLSM1005 | M5 | 5 | 12 | 9 | 18 | 25,5 | 0,6 | 3 | 1,00 | 8,00 | 500 | 74,70 TL |
| IRTU-PLSM1006 | M6 | 6 | 16 | 12 | 21 | 29,5 | 0,6 | 3 | 1,00 | 7,50 | 300 | 86,80 TL |
| IRTU-PLSM1007 | M8 | 8 | 15,5 | 15 | 31,5 | 40 | 1 | 3 | 4,00 | 5,80 | 100 | 148,40 TL |
| IRTU-PLSM1008 | M10 | 10 | 15 | 15 | 31,5 | 40 | 1 | 3 | 4,00 | 7,70 | 100 | 162,50 TL |
| IRTU-PLSM1015 | M8 | 8 | 18 | 15 | 43,3 | 50 | 1 | 3 | 4,00 | 7,70 | 100 | 273,00 TL |
| IRTU-PLSM1016 | M10 | 10 | 18 | 15 | 43,3 | 50 | 1 | 3 | 4,00 | 7,70 | 100 | 286,80 TL |

 960°C
 30s

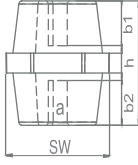
Çift Taraf Kör Somunlu / Two Sided Blind Standoff Insulators

| Kod / Code | Tıp / Type | Ölçüler / Dimensions (mm) | | | | | Kullanım Voltajı ~ kV | Test Voltajı ~ kV | Gerilim Direnci kN | Ağırlık kg/1 box | Kutu Adedi / Box Qty. | Birim Fiyat Price (Adet/pcs) |
|---------------|------------|---------------------------|----|----|------|------|-----------------------|-------------------|--------------------|------------------|-----------------------|------------------------------|
| | | a1 | b1 | b2 | SW | h | | | | | | |
| IRTU-PLSM1009 | M5 | 5 | 9 | 9 | 18 | 25,5 | 0,6 | 3 | 1,00 | 7,50 | 500 | 85,20 TL |
| IRTU-PLSM1010 | M6 | 6 | 12 | 12 | 21 | 29,5 | 0,6 | 3 | 1,00 | 6,30 | 300 | 102,30 TL |
| IRTU-PLSM1011 | M8 | 8 | 15 | 15 | 31,5 | 40 | 1 | 3 | 4,00 | 4,60 | 100 | 168,90 TL |
| IRTU-PLSM1012 | M10 | 10 | 15 | 15 | 31,5 | 40 | 1 | 3 | 4,00 | 5,00 | 100 | 167,10 TL |
| IRTU-PLSM1017 | M8 | 8 | 15 | 15 | 43,3 | 50 | 1 | 3 | 4,00 | 5,00 | 100 | 295,20 TL |
| IRTU-PLSM1018 | M10 | 10 | 15 | 15 | 43,3 | 50 | 1 | 3 | 4,00 | 5,00 | 100 | 296,00 TL |
| IRTU-PLSM1019 | M12 | 10 | 15 | 15 | 43,3 | 50 | 1 | 3 | 4,00 | 5,00 | 100 | 306,20 TL |

Çift Taraf Kör Somunlu SW30 / H30 *Two Sided Blind Standoff Insulators SW30/H30*



960°C
30s

| Kod / Code | Tip / Type | Ölçüler / Dimensions (mm) | | | | | Kullanım Voltajı ~ kV | Test Voltajı ~ kV | Gerilim Direnci kN | Ağırlık kg/1 box | Kutu Adedi / Box Qty. | Birim Fiyat Price (Adet/pcs) |
|-----------------|------------|---------------------------|----|----|----|----|-----------------------|-------------------|--------------------|------------------|-----------------------|------------------------------|
| | | a1 | b1 | b2 | SW | h | | | | | | |
| IRTU-PLSM303006 | M6 | 6 | 11 | 11 | 30 | 30 | 1 | 3 | 4 | 6 | 100 | 165,00 TL |
| IRTU-PLSM303008 | M8 | 8 | 11 | 11 | 30 | 30 | 1 | 3 | 4 | 6,20 | 100 | 167,80 TL |
| IRTU-PLSM303010 | M10 | 10 | 11 | 11 | 30 | 30 | 1 | 3 | 4 | 6,50 | 100 | 170,40 TL |

Çift Taraf Kör Somunlu SW32 / H35 *Two Sided Blind Standoff Insulators SW32/H35*

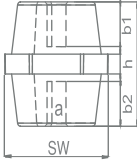

960°C
30s

| Kod / Code | Tip / Type | Ölçüler / Dimensions (mm) | | | | | Kullanım Voltajı ~ kV | Test Voltajı ~ kV | Gerilim Direnci kN | Ağırlık kg/1 box | Kutu Adedi / Box Qty. | Birim Fiyat Price (Adet/pcs) |
|-----------------|------------|---------------------------|----|----|----|----|-----------------------|-------------------|--------------------|------------------|-----------------------|------------------------------|
| | | a1 | b1 | b2 | SW | h | | | | | | |
| IRTU-PLSM323506 | M6 | 6 | 11 | 11 | 32 | 35 | 1 | 3 | 4 | 6,70 | 100 | 168,00 TL |
| IRTU-PLSM323508 | M8 | 8 | 11 | 11 | 32 | 35 | 1 | 3 | 4 | 6,90 | 100 | 170,50 TL |
| IRTU-PLSM323510 | M10 | 10 | 11 | 11 | 32 | 35 | 1 | 3 | 4 | 7,20 | 100 | 172,20 TL |

Çift Taraf Kör Somunlu SW40 / H40 *Two Sided Blind Standoff Insulators SW40/H40*

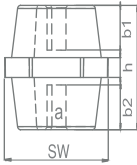

960°C
30s

| Kod / Code | Tip / Type | Ölçüler / Dimensions (mm) | | | | | Kullanım Voltajı ~ kV | Test Voltajı ~ kV | Gerilim Direnci kN | Ağırlık kg/1 box | Kutu Adedi / Box Qty. | Birim Fiyat Price (Adet/pcs) |
|-----------------|------------|---------------------------|----|----|----|----|-----------------------|-------------------|--------------------|------------------|-----------------------|------------------------------|
| | | a1 | b1 | b2 | SW | h | | | | | | |
| IRTU-PLSM404006 | M6 | 6 | 11 | 11 | 40 | 40 | 1 | 3 | 4 | 6,70 | 100 | 179,50 TL |
| IRTU-PLSM404008 | M8 | 8 | 11 | 11 | 40 | 40 | 1 | 3 | 4 | 6,90 | 100 | 182,50 TL |
| IRTU-PLSM404010 | M10 | 10 | 11 | 11 | 40 | 40 | 1 | 3 | 4 | 7,20 | 100 | 185,50 TL |

Çift Taraf Kör Somunlu 1N500 *Two Sided Blind Standoff Insulators 1N500*

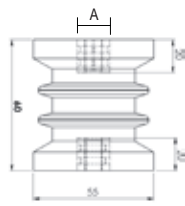

960°C
30s

| Kod / Code | Tip / Type | Somun Ölçüsü Nut Measure (A) | Kullanım Voltajı ~ kV | Test Voltajı ~ kV | Gerilim Direnci kN | Ağırlık kg/18 pcs | Kutu Adedi / Box Qty. | Birim Fiyat Price (Adet/pcs) |
|---------------|------------|------------------------------|-----------------------|-------------------|--------------------|-------------------|-----------------------|------------------------------|
| IRTU-PLSM1020 | 1N500 | M8 | 3 | 15 | 5,00 | 7,00 | 32 | 348,80 TL |
| IRTU-PLSM1021 | 1N500 | M10 | 3 | 15 | 5,00 | 7,00 | 32 | 352,50 TL |
| IRTU-PLSM1022 | 1N500 | M12 | 3 | 15 | 5,00 | 7,00 | 32 | 379,80 TL |

3x1F (10mm) - 3x1F (5mm) Tarak İzolatör (4 TİJ)
 3x1F (10mm) - 3x1F (5mm) Busbar Support Insulator (4 TIJ)

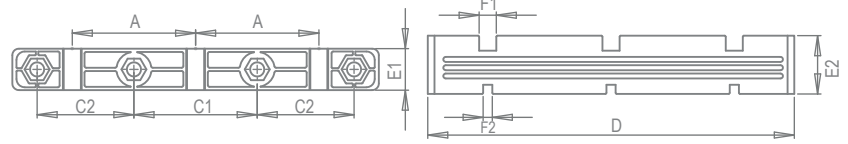

| Kod / Code | Tip / Type | Ölçüler / Dimensions (mm) | | | | | | | | | Min. Direnç kN | Kutu Adedi / Box Qty | Birim Fiyat Unit Price (Adet/pcs) |
|---------------|---------------|---------------------------|----|-------|-----|----|----|------|-----|------|-------------------|-------------------------|---|
| | | A | C1 | C2 | D | E1 | E2 | F1 | F2 | H | | | |
| IRTU-PLST1015 | 3x1F / 5-10mm | 74 | 74 | 58,14 | 220 | 25 | 35 | 10,5 | 5,5 | Ø8,5 | 5 | 50 | 279,80 TL |

3x1F (10mm) - 3x2F (2x5mm) Tarak İzolatör (4 TİJ)
 3x1F (10mm) - 3x2F (2x5mm) Busbar Support Insulator (4 TIJ)

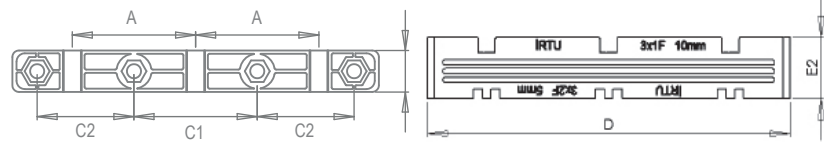
| Kod / Code | Tip / Type | Ölçüler / Dimensions (mm) | | | | | | | | | Min. Direnç kN | Kutu Adedi / Box Qty | Birim Fiyat Unit Price (Adet/pcs) |
|---------------|---------------|---------------------------|----|-------|-----|----|----|------|-----|------|-------------------|-------------------------|---|
| | | A | C1 | C2 | D | E1 | E2 | F1 | F2 | H | | | |
| IRTU-PLST1023 | 3x1F / 5-10mm | 74 | 74 | 58,14 | 220 | 25 | 35 | 10,5 | 5,5 | Ø8,5 | 5 | 50 | 375,00 TL |

3x1F Tarak İzolatör / 3x1F Busbar Support Insulator

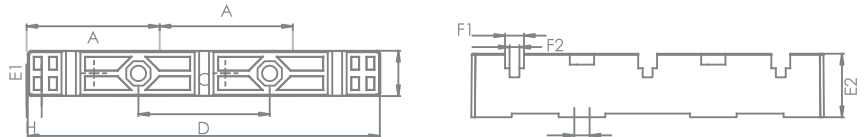
| Kod / Code | Tip / Type | Ölçüler / Dimensions (mm) | | | | | | | | Min. Direnç kN | Kutu Adedi / Box Qty | Birim Fiyat Unit Price (Adet/pcs) |
|---------------|--|---------------------------|----|-----|----|------|------|-----|------|-------------------|-------------------------|---|
| | | A | C | D | E1 | E2 | F1 | F2 | H | | | |
| IRTU-PLST1001 | 3x1F / 5-10mm (Tip Test Belgesi) (Type Test) | 74 | 73 | 196 | 25 | 34,5 | 10,5 | 5,5 | Ø8,5 | 5 | 50 | 271,20 TL |
| IRTU-PLST1000 | 3x1F / 5-10mm | 74 | 73 | 196 | 25 | 34,5 | 10,5 | 5,5 | Ø8,5 | 5 | 50 | 197,50 TL |





65kA

960°C
30s

3x1F+N (5-10mm) Tarak İzolatör / 3x1F+N (5-10mm) Busbar Support Insulator

| Kod / Code | Tip / Type | Ölçüler / Dimensions (mm) | | | | | | | | Min. Direnç kN | Kutu Adedi / Box Qty | Birim Fiyat Unit Price (Adet/pcs) |
|---------------|---------------|---------------------------|----|-----|------|------|------|-----|----|----------------|----------------------|-----------------------------------|
| | | A | C | D | E1 | E2 | F1 | F2 | H | | | |
| IRTU-PLST1003 | 3x1F+N/5-10mm | 65 | 65 | 240 | 25,5 | 35,0 | 10,5 | 5,5 | Ø9 | 5 | 50 | 369,80 TL |

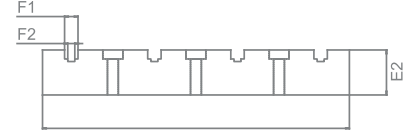
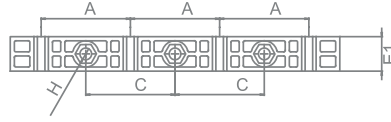

4x1F (10mm) - 4x2F (5mm) Tarak İzolatör
4x1F (10mm) - 4x2F (5mm) Busbar Support Insulator



960°C
30s

| Kod / Code | Tip / Type | Ölçüler / Dimensions (mm) | | | | | | | | | | Min. Direnç kN | Kutu Adedi / Box Qty | Birim Fiyat Unit Price (Adet/pcs) |
|---------------|--------------|---------------------------|------|------|----|------|------|-----|----|----|-----|----------------|----------------------|-----------------------------------|
| | | A | A1 | A2 | A3 | B | C | D | E | F | L | | | |
| IRTU-PLST1021 | 4x1F - 10 mm | 10,5 | 54 | 65 | | 64,5 | 61,5 | 8,5 | 25 | 35 | 285 | 5 | 50 | 385,20 TL |
| | 4x2F -5mm | 5,5 | 48,5 | 48,5 | 16 | 64,5 | 61,5 | 8,5 | 25 | 35 | 285 | | | |

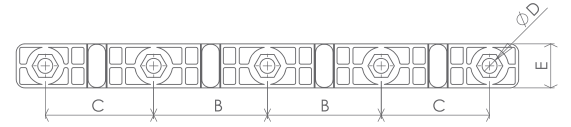
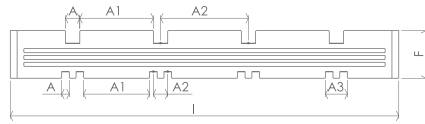

3x2F (10mm) Tarak İzolatör / 3x2F (10mm) Busbar Support Insulator



65kA

960°C
30s

| Kod / Code | Tip / Type | Ölçüler / Dimensions (mm) | | | | | | | | Min. Direnç kN | Kutu Adedi / Box Qty | Birim Fiyat Unit Price (Adet/pcs) | |
|---------------|---------------|---------------------------|------|----|-----|-----|------|------|------|----------------|----------------------|-----------------------------------|-----------|
| | | A1 | A2 | C1 | C2 | D | E1 | E2 | F | | | | H |
| IRTU-PLST1002 | 3x2F / 10 mm. | 20,5 | 81,3 | 80 | 105 | 290 | 25,0 | 34,5 | 10,5 | Ø8,5 | 5 | 50 | 460,60 TL |

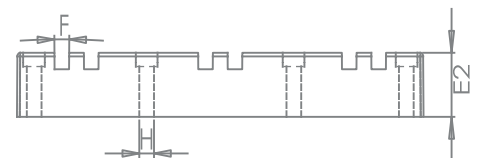
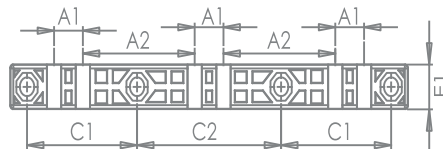

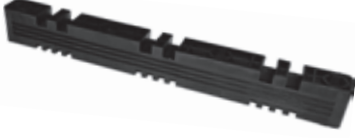
3x2F (10mm) - 3x4F (5mm) Tarak İzolatör
 3x2F (10mm) - 3x4F (5mm) Busbar Support Insulator

 960°C
 30s

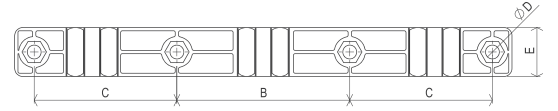
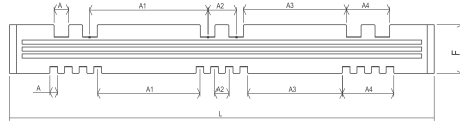
| Kod / Code | Tip / Type | Ölçüler / Dimensions (mm) | | | | | | | | | | | Min. Direnç kN | Kutu Adedi / Box Qty | Birim Fiyat Unit Price (Adet/pcs) |
|---------------|---------------|---------------------------|------|------|----|----|-----|------|-----|----|----|-----|-------------------|-------------------------|---|
| | | A | A1 | A2 | A3 | A4 | B | C | D | E | F | L | | | |
| IRTU-PLST1022 | 3x2F - 10 mm. | 10,5 | 84,5 | 20,5 | 74 | 31 | 106 | 87,5 | 8,5 | 30 | 35 | 305 | 5 | 50 | 430,70 TL |
| | 3x4F - 5 mm. | 5,5 | 73,5 | 10,5 | 68 | 37 | 106 | 87,5 | 8,5 | 30 | 35 | 305 | | | |

4x2F (10mm) - 4x2F (5mm) Tarak İzolatör
 4x2F (10mm) - 4x2F (5mm) Busbar Support Insulator

 960°C
 30s

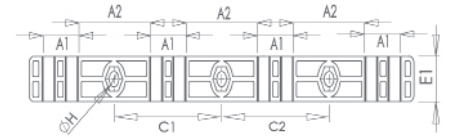
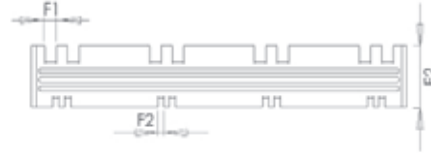
| Kod / Code | Tip / Type | Ölçüler / Dimensions (mm) | | | | | | | | | | Min. Direnç kN | Kutu Adedi / Box Qty | Birim Fiyat Unit Price (Adet/pcs) |
|---------------|-------------------------------|---------------------------|----|----|----|-----|------|----|------|-----|------|-------------------|-------------------------|---|
| | | A1 | A2 | C1 | C2 | D | E1 | E2 | F1 | F2 | H | | | |
| IRTU-PLST1016 | 4x2F / 10 mm. 4x2F / 5 mm. | 31 | 64 | 95 | 95 | 340 | 25,0 | 35 | 10,5 | 5,5 | Ø8,5 | 5 | 50 | 478,90 TL |

4x2F (10 mm) - 4x4F (5 mm) Tarak İzolatör
 4x2F (10 mm) - 4x4F (5 mm) Busbar Support Insulator

 960°C
 30s

| Kod / Code | Tip / Type | Ölçüler / Dimensions (mm) | | | | | | | | Min. Direnç kN | Kutu Adedi / Box Qty | Birim Fiyat Unit Price (Adet/pcs) |
|---------------|-------------------------------|---------------------------|----|----|-----|-----|------|-----|------|-------------------|-------------------------|---|
| | | L | W | H | PD1 | PD2 | SW1 | SW2 | TH | | | |
| IRTU-PLST1026 | 4x2F / 10 mm. 4x4F / 5 mm. | 31 | 64 | 95 | 95 | 370 | 25,0 | 35 | 10,5 | 5 | 50 | 392,00 TL |

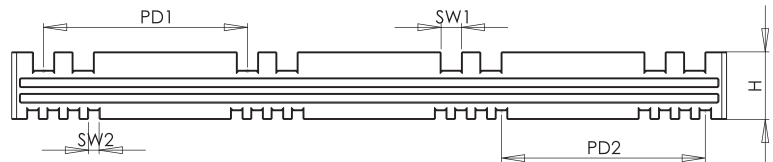
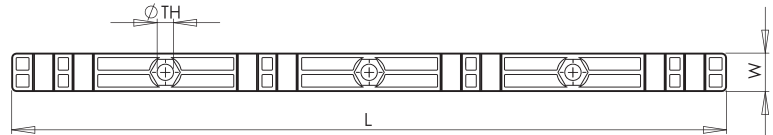



960°C
30s

3x3F (10mm) - 3x4F (5mm) Tarak İzolatör
3x3F (10mm) - 3x4F (5mm) Busbar Support Insulator

| Kod / Code | Tip / Type | Ölçüler / Dimensions (mm) | | | | | | | | | | | Min. Direnç kN | Kutu Adedi / Box Qty | Birim Fiyat Unit Price (Adet/pcs) |
|---------------|---------------|---------------------------|----|------|-------|------|-------|-------|-----|----|----|-----|-------------------|-------------------------|---|
| | | A | A1 | A2 | A3 | A4 | B | C | D | E | F | L | | | |
| IRTU-PLST1024 | 3x3F - 10 mm. | 10,5 | 74 | 20,5 | 125,5 | 51,5 | 125,5 | 109,5 | 8,5 | 30 | 35 | 380 | 5 | 50 | 516,20 TL |
| | 3x5F - 5 mm. | 5,5 | 78 | 10,5 | 125,5 | 47,5 | 125,5 | 109,5 | 8,5 | 30 | 35 | 380 | 5 | | |

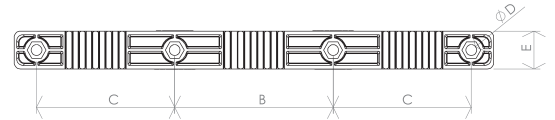
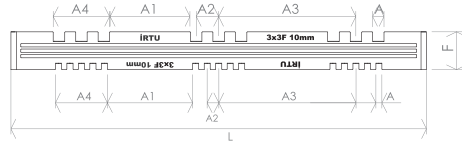

1x6F (5 mm) Tarak İzolatör / 1x6F (5 mm) Busbar Support Insulator

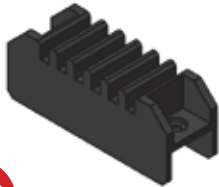

960°C
30s

| Kod / Code | Tip / Type | Ölçüler / Dimensions (mm) | | | | | | | | | Min. Direnç kN | Kutu Adedi / Box Qty | Birim Fiyat Unit Price (Adet/pcs) |
|---------------|------------|---------------------------|------|--------|----|-----|----|------|------|-----|-------------------|-------------------------|---|
| | | A | C | C1 | D | F1 | I | E1 | E2 | G | | | |
| IRTU-PLST1025 | 1x6F/5 mm. | 10,5 | 25,0 | 8x12,4 | 95 | 5,5 | 75 | 30,0 | 37,0 | 5,0 | 5 | 100 | 169,90 TL |

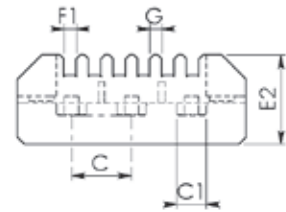
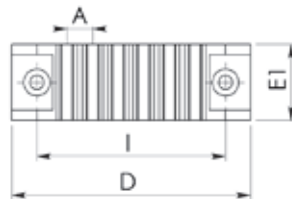

| Kod / Code | Tip / Type | Kullanılan İzolatör Adedi/ Number of Insulators Used | Kullanılan Saç Profil Uzunluğu/ The Length of the Sheet Profile Used | Kutu Adedi / Box Qty | Birim Fiyat Unit Price (Adet/pcs) |
|---------------|----------------------------|--|--|-------------------------|---|
| IRTU-PLST1325 | 1x6F/5 mm 3 Faz Takım | 6 | 575 mm | 1 | 5.907,00 TL |
| IRTU-PLST1425 | 1x6F/5 mm 3 Faz+N Takım | 8 | 675 mm | 1 | 6.858,00 TL |

1x4F (5 mm) Tarak İzolatör / 1x4F (5 mm) Busbar Support Insulator

 960°C
 30s

| Kod / Code | Tip / Type | Ölçüler / Dimensions (mm) | | | | | | | | | Min. Direnç kN | Kutu Adedi / Box Qty | Birim Fiyat Unit Price (Adet/pcs) |
|---------------|------------|---------------------------|----|--------|----|----|-----|----|----|----|-------------------|-------------------------|---|
| | | A | C | C1 | D | I | F | E1 | E2 | G | | | |
| IRTU-PLST1020 | 1x4F/5 mm. | 15,5 | 25 | 8X12,4 | 90 | 75 | 5,5 | 30 | 37 | 10 | 5 | 100 | 168,70 TL |

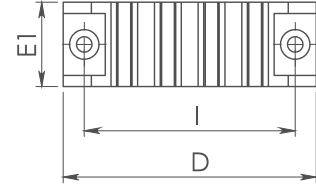
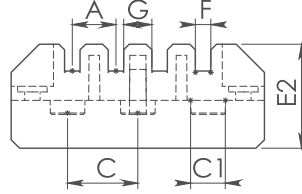

| Kod / Code | Tip / Type | Kullanılan İzolatör Adedi/ Number of Insulators Used | Kullanılan Saç Profil Uzunluğu/ The Length of the Sheet Profile Used | Kutu Adedi / Box Qty | Birim Fiyat Unit Price (Adet/pcs) |
|---------------|-------------------------|--|--|-------------------------|---|
| IRTU-PLST1320 | 1x4F/5 mm 3 Faz Takım | 6 | 575 mm | 1 | 5.887,00 TL |
| IRTU-PLST1420 | 1x4F/5 mm 3 Faz+N Takım | 8 | 675 mm | 1 | 6.853,00 TL |

1x4F (5 mm) Tarak İzolatör / 1x4F (5 mm) Busbar Support Insulator

65kA

 960°C
 30s

| Kod / Code | Tip / Type | Ölçüler / Dimensions (mm) | | | | | | | | Min. Direnç kN | Kutu Adedi / Box Qty | Birim Fiyat Unit Price (Adet/pcs) |
|---------------|------------|---------------------------|------|----|------|-----|------|----|-----|-------------------|-------------------------|---|
| | | A | C | C1 | D | F1 | E1 | E2 | G | | | |
| IRTU-PLST1005 | 1x4F/5 mm. | 10,5 | 20,0 | 8 | 65,0 | 5,5 | 35,5 | 30 | 5,0 | 5 | 100 | 144,90 TL |

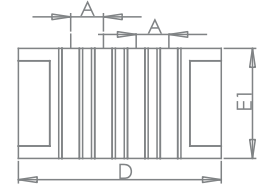
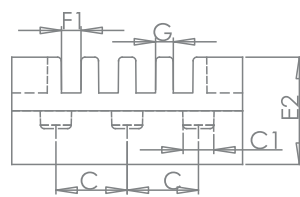

| Kod / Code | Tip / Type | Kullanılan İzolatör Adedi/ Number of Insulators Used | Kullanılan Saç Profil Uzunluğu/ The Length of the Sheet Profile Used | Kutu Adedi / Box Qty | Birim Fiyat Unit Price (Adet/pcs) |
|---------------|-------------------------|--|--|-------------------------|---|
| IRTU-PLST1305 | 1x4F/5 mm 3 Faz Takım | 6 | 430 mm | 1 | 5.160,00 TL |
| IRTU-PLST1405 | 1x4F/5 mm 3 Faz+N Takım | 8 | 600 mm | 1 | 6.178,00 TL |



1x4F (10 mm) Tarak İzolatör (Altı Düz Tip) / 1x4F (10 mm) Busbar Support Insulator



960°C
30s

| Kod / Code | Tip / Type | Ölçüler / Dimensions (mm) | | | | | | | Min. Direnç kN | Kutu Adedi / Box Qty | Birim Fiyat Unit Price (Adet/pcs) |
|---------------|-------------|---------------------------|-----|------|-----|----|----|----|-------------------|-------------------------|---|
| | | A | C | D | E1 | E2 | F1 | F2 | | | |
| IRTU-PLST1009 | 1x4F / 10mm | 20,5 | 115 | 10,5 | 100 | 35 | 35 | 10 | 5 | 100 | 251,00 TL |

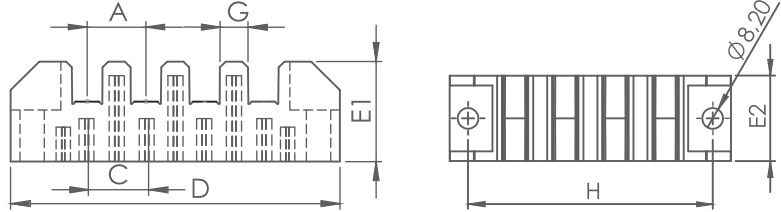

1x4F (10 mm) Tarak İzolatör / 1x4F (10 mm) Busbar Support Insulator



80kA

960°C
30s

| Kod / Code | Tip / Type | Ölçüler / Dimensions (mm) | | | | | | | | | Min. Direnç kN | Kutu Adedi / Box Qty | Birim Fiyat Unit Price (Adet/pcs) |
|---------------|-------------|---------------------------|------|---------|-----|-----|-----|----|----|----|-------------------|-------------------------|---|
| | | A | C | C1 | D | F | I | E1 | E2 | G | | | |
| IRTU-PLST1006 | 1x4F/10 mm. | 20,5 | 20,0 | 8,4x8,4 | 115 | 105 | 100 | 35 | 35 | 10 | 5 | 100 | 210,00 TL |

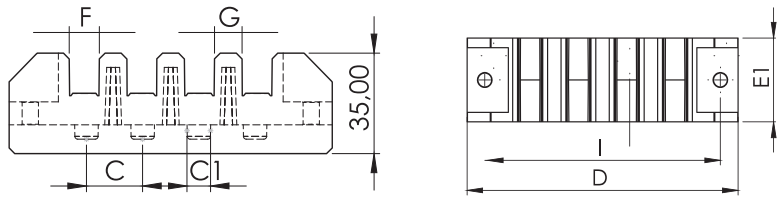

| Kod / Code | Tip / Type | İzolatör Adedi/ Number of Insulators | Saç Profil Uzunluğu/ The Length of the Sheet Profile | Adet / Qty. | Fiyat / Price (Adet/pcs) |
|---------------|---|---|---|----------------|-----------------------------|
| IRTU-PLST1306 | 1x4F/10 mm 3 Faz Takım 3 Phase Close Set | 6 | 575 mm | 1 | 6.650,00 TL |
| IRTU-PLST1406 | 1x4F/10 mm 3 Faz+N Takım 3 Phase+N Close Set | 8 | 675 mm | 1 | 7.516,00 TL |

1x3F (5 mm) Tarak İzolatör / 1x3F (5 mm) Busbar Support Insulator

 960°C
 30s

| Kod / Code | Tip / Type | Ölçüler / Dimensions (mm) | | | | | | | | | Min. Direnç kN | Kutu Adedi / Box Qty | Birim Fiyat Unit Price (Adet/pcs) |
|---------------|------------|---------------------------|------|--------|------|-----|------|------|------|-----|-------------------|----------------------------|---|
| | | A | C | C1 | D | F | I | E1 | E2 | G | | | |
| IRTU-PLST1011 | 1x3F/5 mm. | 10,5 | 25,0 | 8x12,4 | 65,0 | 5,5 | 50,0 | 30,0 | 37,0 | 5,0 | 5 | 100 | 136,90 TL |

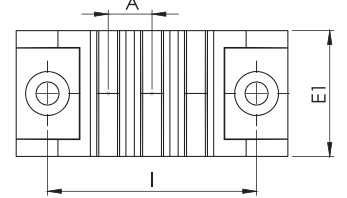
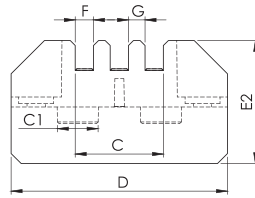

| Kod / Code | Tip / Type | Kullanılan İzolatör Adedi/ Number of Insulators Used | Kullanılan Saç Profil Uzunluğu/ The Length of the Sheet Profile Used | Kutu Adedi / Box Qty | Birim Fiyat Unit Price (Adet/pcs) |
|---------------|----------------------------|--|--|----------------------------|---|
| IRTU-PLST1311 | 1x3F/5 mm 3 Faz Takım | 6 | 430 mm | 1 | 5.055,00 TL |
| IRTU-PLST1411 | 1x3F/5 mm 3 Faz+N Takım | 8 | 600 mm | 1 | 6.178,00 TL |

1x2F - 1x3F (5-10mm) Tarak İzolatör / 1x2F - 1x3F (5-10 mm) Busbar Support Insulator

 960°C
 30s

| Kod / Code | Tip / Type | Ölçüler / Dimensions (mm) | | | | | Min. Direnç kN | Kutu Adedi/ Box Qty | Birim Fiyatı Price (adet/pcs) |
|---------------|----------------------|---------------------------|-----|-----|----|----|-------------------|---------------------------|-------------------------------------|
| | | A | D | H | E1 | E2 | | | |
| IRTU-PLST1012 | 1x2F - 1x3F / 5-10mm | 20,5 | 120 | 100 | 35 | 30 | 5 | 100 | 275,70 TL |

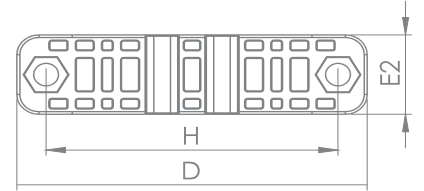
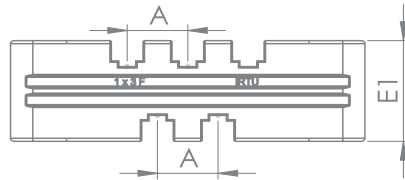

1x3F (10 mm) Tarak İzolator / 1x3F (10mm) Busbar Support Insulator



960°C
30s



| Kod / Code | Tip / Type | Ölçüler / Dimensions (mm) | | | | | | | | | | Min. Direnç kN | Kutu Adedi / Box Qty | Birim Fiyat Unit Price (Adet/pcs) |
|---------------|---------------|---------------------------|----|--------|----|------|-----|------|----|----|-----|----------------|----------------------|-----------------------------------|
| | | A | C | C1 | D | F | H | I | E1 | E2 | G | | | |
| IRTU-PLST1008 | 1x3F / 10 mm. | 20,5 | 25 | 8x12,4 | 90 | 10,5 | 12 | 10,5 | 30 | 37 | Ø10 | 5 | 100 | 165,00 TL |
| IRTU-PLST1018 | 1x3F / 10 mm. | 20,5 | 25 | 8x12,4 | 90 | 10,5 | 9,5 | 75 | 30 | 37 | Ø10 | 5 | 100 | 165,00 TL |

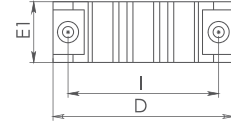
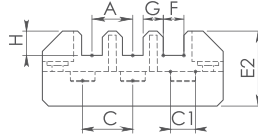

| Kod / Code | Tip / Type | Kullanılan İzolatör Adedi/ Number of Insulators Used | Kullanılan Saç Profil Uzunluğu/ The Length of the Sheet Profile Used | Kutu Adedi / Box Qty | Birim Fiyat Unit Price (Adet/pcs) |
|---------------|---|--|--|----------------------|-----------------------------------|
| IRTU-PLST1308 | 1x3F/10 mm 3 Faz Takım 3 Phase Close Set | 6 | 575 mm | 1 | 5.843,00 TL |
| IRTU-PLST1408 | 1x3F/10 mm 3 Faz+N Takım 3 Phase+N Close Set | 8 | 675 mm | 1 | 6.805,00 TL |

1x3F (10 mm) Tarak İzolatör / 1x3F (10 mm) Busbar Support Insulator



960°C
30s



| Kod / Code | Tip / Type | Ölçüler / Dimensions (mm) | | | | | | | | | | | Min. Direnç kN | Kutu Adedi / Box Qty | Birim Fiyat Unit Price (Adet/pcs) |
|---------------|-------------|---------------------------|------|------|------|----|----|----|----|------|------|------|----------------|----------------------|-----------------------------------|
| | | A | D | F | I | E1 | E2 | G | C | C1 | N | M | | | |
| IRTU-PLST1010 | 1x3F/10 mm. | 21 | 69,6 | 10,5 | 51,5 | 55 | 25 | 10 | 63 | 35,5 | 3,35 | 15,7 | 5 | 100 | 118,00 TL |

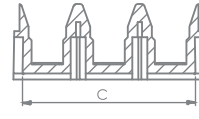
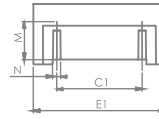
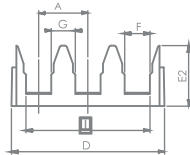

| Kod / Code | Tip / Type | Kullanılan İzolatör Adedi/ Number of Insulators Used | Kullanılan Saç Profil Uzunluğu/ The Length of the Sheet Profile Used | Kutu Adedi / Box Qty | Birim Fiyat Unit Price (Adet/pcs) |
|---------------|---|--|--|----------------------|-----------------------------------|
| IRTU-PLST1310 | 1x3F/10 mm 3 Faz Takım 3 Phase Close Set | 6 | 575 mm | 1 | 5.499,00 TL |
| IRTU-PLST1410 | 1x3F/10 mm 3 Faz+N Takım 3 Phase+N Close Set | 8 | 675 mm | 1 | 6.316,00 TL |

1x2F (10 mm) Tarak İzolatör / 1x2F (10 mm) Busbar Support Insulator

 960°C
 30s

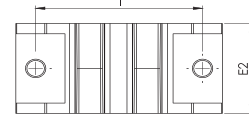
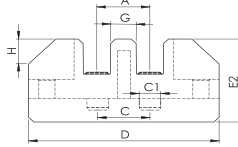

| Kod / Code | Tip / Type | Ölçüler / Dimensions (mm) | | | | | | | | | | Min. Direnç kN | Kutu Adedi / Box Qty | Birim Fiyat Unit Price (Adet/pcs) |
|---------------|---------------|---------------------------|----|--------|----|------|-----|----|----|----|-----|-------------------|-------------------------|---|
| | | A | C | C1 | D | F | H | I | E1 | E2 | G | | | |
| IRTU-PLST1007 | 1x2F / 10 mm. | 20,5 | 25 | 8x12,4 | 65 | 10,5 | 12 | 50 | 30 | 37 | Ø10 | 5 | 100 | 113,30 TL |
| IRTU-PLST1017 | 1x2F / 10 mm. | 20,5 | 25 | 8x12,4 | 65 | 10,5 | 9,5 | 50 | 30 | 33 | Ø10 | 5 | 100 | 113,30 TL |



| Kod / Code | Tip / Type | Kullanılan İzolatör Adedi/ Number of Insulators Used | Kullanılan Saç Profil Uzunluğu/ The Length of the Sheet Profile Used | Kutu Adedi / Box Qty | Birim Fiyat Unit Price (Adet/pcs) |
|---------------|---|--|--|-------------------------|---|
| IRTU-PLST1307 | 1x2F/10 mm 3 Faz Takım 3 Phase Close Set | 6 | 430 mm | 1 | 4.844,00 TL |
| IRTU-PLST1407 | 1x2F/10 mm 3 Faz+N Takım 3 Phase+N Close Set | 8 | 600 mm | 1 | 5.832,00 TL |

Kablo Geçiş İzolatör / Cable Transition Insulator

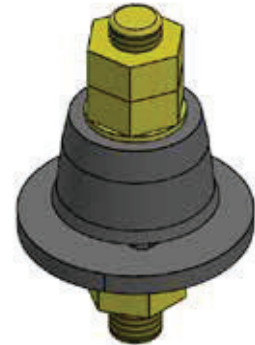
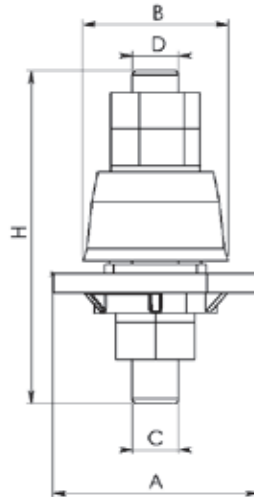
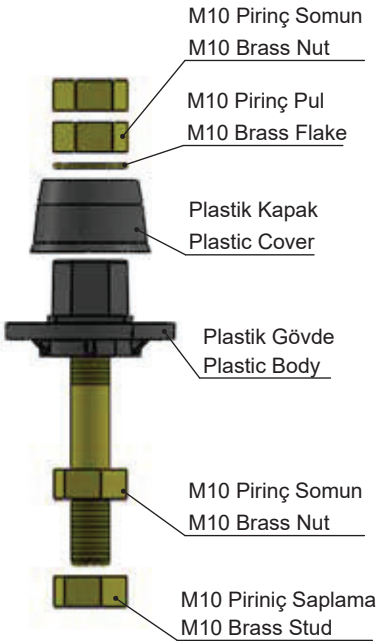
| Kod / Code | Tip / Type | Ölçüler / Dimensions (mm) | | | | | Kutu Adedi / Box Qty | Birim Fiyat Unit Price (Adet/pcs) |
|---------------|--|---------------------------|-------|-----|-----|-------|-------------------------|---|
| | | A | B | C | D | H | | |
| IRTU-PLST5001 | Kablo Geçiş İzolatörü Cable Transition Insulators | Ø44,50 | Ø31,5 | M10 | M10 | 72,50 | 50 | 1.298,00 TL |



3 Faz Takım Bağlantı Seti / 3 Phase Connection Set

3 Faz Takım Bağlantı Şeması / 3 Phase Connection Diagram

| Ürün Tanımı Product Description | Ürün Resmi Product Image | Adet Piece |
|---|---|---------------|
| İzolator Insulator |  | 6 |
| Alt Bağlantı Profili Bottom Link Profile |  | 1 |
| Üst Bağlantı Profili Top Link Profile |  | 1 |
| Gijon Gijon |  | 4 |
| Somun Nut |  | 8 |
| Rondela Washer |  | 8 |

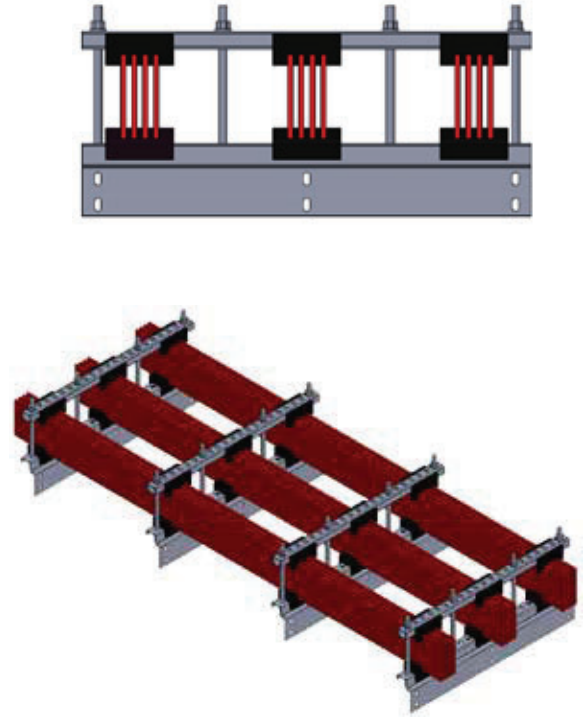

4 Faz Takım Bağlantı Seti / 4 Phase Connection Set

4 Faz Takım Bağlantı Şeması / 4 Phase Connection Diagram

| Ürün Tanımı Product Description | Ürün Resmi Product Image | Adet Piece |
|---|---|---------------|
| İzolator Insulator |  | 8 |
| Alt Bağlantı Profili Bottom Link Profile |  | 1 |
| Üst Bağlantı Profili Top Link Profile |  | 1 |
| Gijon Gijon |  | 5 |
| Somun Nut |  | 10 |
| Rondela Washer |  | 10 |

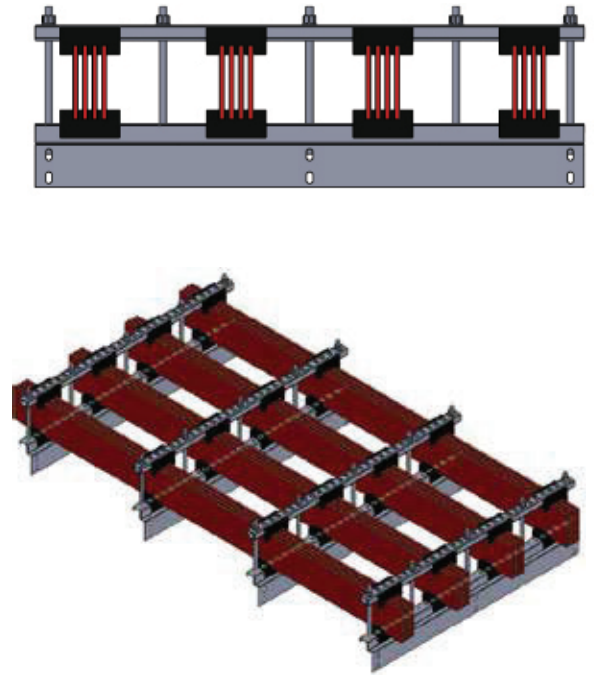

Geçiş İzolatörü / Transition Insulator

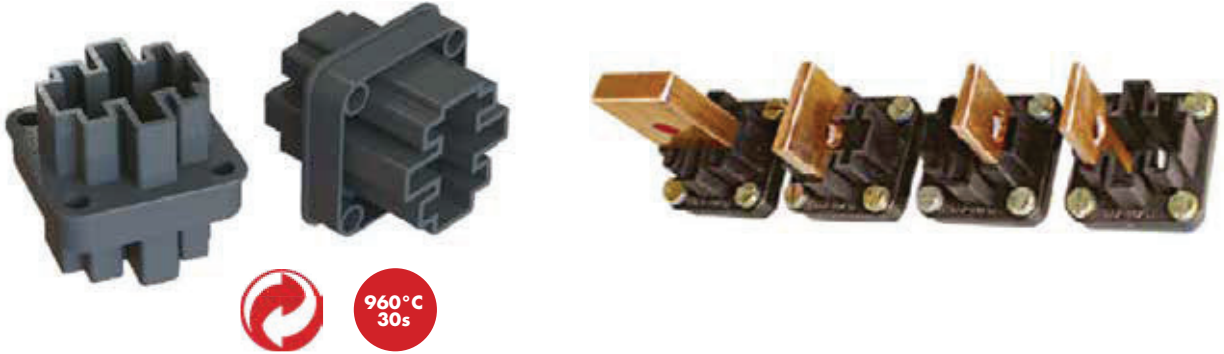

| Kod / Code | Tip / Type | Ölçüler / Dimensions (mm) | | | | | Min. Direnç kN | Kutu Adedi / Box Qty | Birim Fiyat Unit Price (Adet/pcs) |
|---------------|--|---------------------------|------|------|------|------|-------------------|-------------------------|---|
| | | A | B | C | D | E | | | |
| IRTU-PLST1013 | Geçiş İzolatörü /Transition Insulators 20x3/20x4/30x5/30x10 | 45,0 | 45,0 | 35,0 | 35,0 | 5,80 | 5 | 100 | 104,70 TL |
| IRTU-PLST1014 | Geçiş İzolatörü /Transition Insulators 25x5/20x10/40x10/50x10 | 60,0 | 60,0 | 45,0 | 45,0 | 6,50 | 5 | 100 | 136,40 TL |

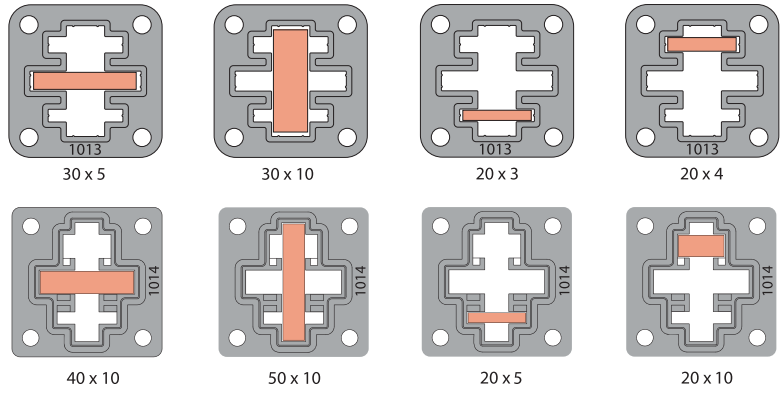
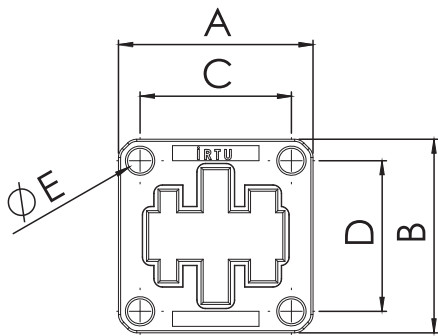
GEÇİŞ İZOLATÖR ÖZELLİKLERİ
BUSHING PROPERTIES

| | |
|---|---|
| Materyal Material | Cam Takviyeli Polyamid 6.6 Glass Reinforced Polyamid 6.6 |
| Sıcaklık Dayanımı Temperature Resistance | 140°C |
| Yanmazlık Nonflammability | UL94-V0 |
| Voltaj Toleransı Voltage Tolerance | 690V |
| Yanmazlık Insulation Voltage U | 690V |
| Darbe Gerilimi Impulse Voltage U | 8 kV |
| Kızaran Tel Testi Glow Wire | 960°C |

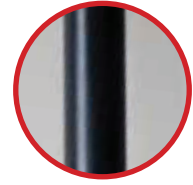
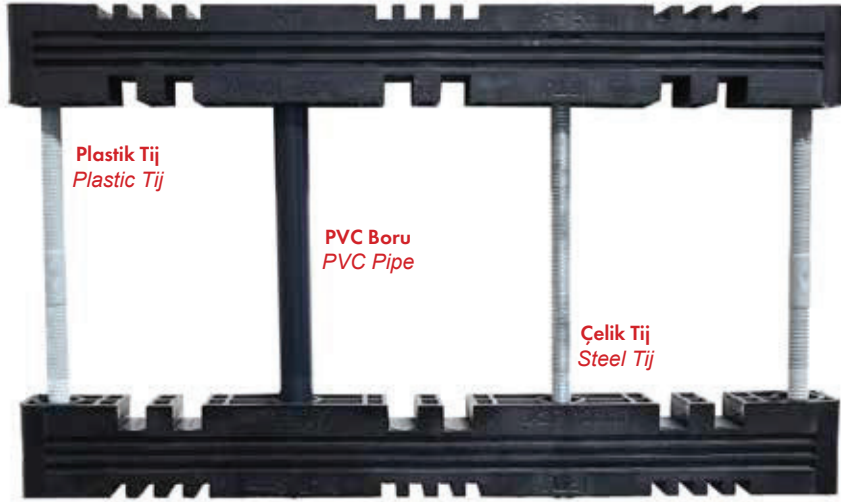

PVC Boru / PVC Pipe



Plastik / Plastic



Çelik / Steel

M8 Tij / M8 Threaded Rod



| Kod / Code | Tip / Type | A | L | Kutu Adedi / Box Qty | Birim Fiyat Unit Price (Adet/pcs) |
|--------------|--|----|-------|----------------------|-----------------------------------|
| IRTU-PTJ2008 | M8 Plastik Tij / M8 Plastic Threaded Rod | M8 | 200mm | 100 Ad | 33,50 TL |
| IRTU-CTJ2008 | M8 Çelik Tij / M8 Steel Threaded Rod | M8 | 200mm | 100 Ad | |
| IRTU-CTJ8002 | M8 Çelik Tij / M8 Steel Threaded Rod | M8 | 2mt | 100 mt | |



PVC İzolasyon Boru / PVC Isolation Pipe



| Kod / Code | Tip / Type | A | L | Kutu Adedi / Box Qty | Birim Fiyat Unit Price (mt) |
|---------------|--|------|-----|----------------------|-----------------------------|
| IRTU-PVCB4767 | PVC İzolasyon Boru Pvc Isolation Pipe | 13mm | 2mt | 50 | 3,85 € |





POLYESTER İZOLATÖRLER

POLYESTER INSULATORS

Anma gerilimi 1000V'a kadar olan Alçak Gerilim Mesnet İzolatörler dahili ortamlarda bakır barayı bir kaideye üzerine montaj etmek amacı ile kullanılan ürünlerdir.

Ortam Koşullarına dayanıklı, esnek, yüksek mekanikli dayanımlı cam elyafının bir araya getirilmesi ile meydana getirilen: yüksek özgül mukavemet ve ısı özellikler, elastikiyet, hafiflik, mükemmel dielektrik nitelikler, kalıplama ve tasarım esnekliği sağlayan BMC malzemeden imal edilir

Low voltage support insulators with rated voltage up to 1000V, are used to mount copper busbars onto a base in indoor environments.

They are manufactured from BMC material formed by combining flexible, high mechanical strength glass fibers that are resistant to environmental conditions. This composition provides high specific strength and thermal performance, along with elasticity, light weight, excellent dielectric properties, molding and design flexibility.

POLYESTER (BMC) İZOLATÖRLER

Anma gerilimi 1000 V'a kadar olan Alçak Gerilim Mesnet İzolatörler dahil ortamlarda bakır barayı bir kaideye üzerine montaj etmek amacı ile kullanılan ürünlerdir. Mesnet izolatörler ürünlerin kullanıldıkları ortamlarda ana can damarlarından birisidir. Ortam koşullarına dayanıklı esnek, yüksek mekanik dayanımlı cam elyafının bir araya getirilmesi ile meydana getirilen: yüksek özgül mukavemet ve ısı özellikler, elastikiyet, hafiflik, mükemmel dielektrik nitelikler, kalıplama ve tasarım esnekliği sağlaya BMC malzemeden imal edilir.

Kimyasal özellikleri aşağıdaki gibidir:

- Cam elyaf takviyeli polyester, %18 elyaf ihtiva eder.
- Standart renk Irox red 130 (ihtiyaç halinde farklı renk uygulanabilir)
- Körsomunlar: çelik çinko kaplamalı (istek üzerine prinç malzeme)
- Civata: cr3 8.8 çelik civata.

Low tension post insulators, whose rated voltage can go up to 1000 V, are used to join a copper bar to a base in indoor.

Post insulators are the one of the most important element in where they used

It is made of BMC material, which is manufactured by combining flexible, high mechanical strength glass fiber, providing high specific strength and thermal properties, excellent dielectric properties, molding and design flexibility.

It's chemical charecters are listed below:

- Fiber glass reinforced polyester, has 18% of fibers.
- Standard color, Irox red 130. (different colors can be applied if necessary)
- Cap Nuts : steel-zinc lined. (brass material can used if requested)
- Bolt: Cr3 8.8 steel bolt

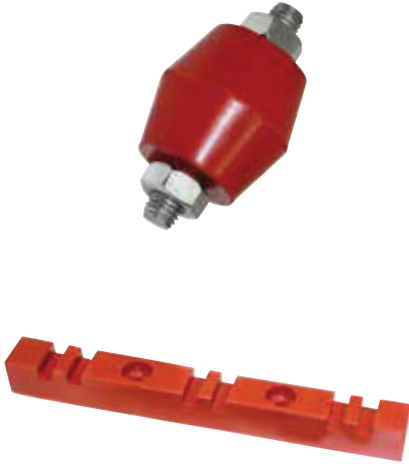

| Uygun Çalışma Sıcaklığı <i>Proper Operating Temperature</i> | Genel elektroteknik uygulaması Sıcaklık aralığı | <i>General electrotechnical application.</i> <i>Temperature range</i> | -40 °C to +130 °C | |
|--|---|--|--|---|
| Fiziksel Özellikler <i>Pyhsical Properties</i> | Cam elyaf oranı Özkütle Kalıp çekmesi Su emme | <i>Fiber Glass Ratio</i> <i>Density</i> <i>Moulding Shrinkage</i> <i>Water Absorption</i> | 18% 1,75g/cm ³ <0,1% <0,2% (<25mg) | DIN 53479 DIN EN ISO 62 |
| Mekanik Özellikler <i>Mechanical Properties</i> | Martens derecesi Bükülme dayanıklılığı Darbe dayanıklılığı | <i>Martens Degree</i> <i>Flexural Strength</i> <i>Impact Strength</i> | >200°C 90 N/mm ² 25-30 kJ/m ² | DIN 53462 DIN EN ISO 178 DIN EN ISO 179 |
| Elektriksel Özellikler <i>Electrical Properties</i> | Yüzey direnci Elektrik öz direnci Dielectric dayanımı Alev alma dayanımı | <i>Surface Resistivity</i> <i>Volume Resistivity</i> <i>Dielectric Strength</i> <i>Flame Resistance</i> | 10 ¹⁴ Ωcm 10 ¹⁴ Ωcm 150 kV/cm CTI 600 | DIN IEC 60093 DIN IEC 60093 DIN EN 60243-1 DIN IEC 60112 |
| Yanmazlık <i>Flammability</i> | Kızaran tel testi | <i>Glow –wire Flammability</i> | 960° C | DIN EN 60695 |

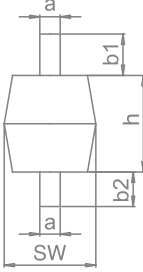
Çift Taraf Saplmalı / Busbar Standoff insulators with Double side Screw

 960 °C
 30s

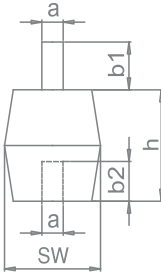
| Kod / Code | Tip / Type | Ölçüler / Dimensions (mm) | | | | | Kullanım Voltajı Usage Voltage ~ kV | Test Voltajı Test Voltage ~ kV | Gerilim Direnci Voltage Resistance kN | Ağırlık Weight kg / Box | Kutu Adedi / Box Qty. | Birim Fiyat Price (Adet/pcs) |
|---------------|------------|---------------------------|----|----|----|----|---|--------------------------------------|--|-------------------------------|-----------------------------|------------------------------------|
| | | a1 | b1 | b2 | SW | h | | | | | | |
| IRTU-POLM1001 | M5 | 5 | 12 | 12 | 22 | 24 | 0,6 | 3 | 0,75 | 11,00 | 500 | 51,30 TL |
| IRTU-POLM1002 | M6 | 6 | 15 | 15 | 27 | 28 | 0,6 | 3 | 1,00 | 12,00 | 300 | 56,60 TL |
| IRTU-POLM1003 | M8 | 8 | 16 | 19 | 40 | 40 | 1 | 3 | 2,50 | 10,50 | 100 | 99,30 TL |
| IRTU-POLM1004 | M10 | 10 | 12 | 15 | 40 | 40 | 1 | 3 | 2,70 | 14,00 | 100 | 120,10 TL |

Saplmalı & Kör Somunlu / Busbar Standoff insulators with One Side Screw

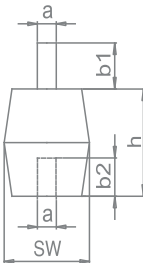
 960 °C
 30s

| Kod / Code | Tip / Type | Ölçüler / Dimensions (mm) | | | | | Kullanım Voltajı Usage Voltage ~ kV | Test Voltajı Test Voltage ~ kV | Gerilim Direnci Voltage Resistance kN | Ağırlık Weight kg / Box | Kutu Adedi / Box Qty. | Birim Fiyat Price (Adet/pcs) |
|---------------|------------|---------------------------|----|----|----|----|---|--------------------------------------|--|-------------------------------|-----------------------------|------------------------------------|
| | | a1 | b1 | b2 | SW | h | | | | | | |
| IRTU-POLM1005 | M5 | 5 | 12 | 12 | 22 | 24 | 0,6 | 3 | 0,75 | 10,50 | 500 | 61,60 TL |
| IRTU-POLM1006 | M6 | 6 | 15 | 15 | 27 | 28 | 0,6 | 3 | 1,00 | 10,80 | 300 | 73,00 TL |
| IRTU-POLM1007 | M8 | 8 | 16 | 15 | 40 | 40 | 1 | 3 | 2,50 | 9,80 | 100 | 114,40 TL |
| IRTU-POLM1008 | M10 | 10 | 15 | 15 | 40 | 40 | 1 | 3 | 2,70 | 11,40 | 100 | 136,00 TL |

Çift Taraf Kör Somunlu / Two sided blind standoff insulators

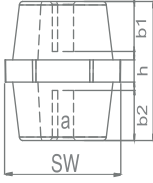
 960 °C
 30s

| Kod / Code | Tip / Type | Ölçüler / Dimensions (mm) | | | | | Kullanım Voltajı Usage Voltage ~ kV | Test Voltajı Test Voltage ~ kV | Gerilim Direnci Voltage Resistance kN | Ağırlık Weight kg / Box | Kutu Adedi / Box Qty. | Birim Fiyat Price (Adet/pcs) |
|---------------|------------|---------------------------|----|----|----|----|---|--------------------------------------|--|-------------------------------|-----------------------------|------------------------------------|
| | | a1 | b1 | b2 | SW | h | | | | | | |
| IRTU-POLM1009 | M5 | 5 | 9 | 9 | 22 | 24 | 0,6 | 3 | 0,75 | 10,00 | 500 | 112,10 TL |
| IRTU-POLM1010 | M6 | 6 | 12 | 12 | 27 | 28 | 0,6 | 3 | 1,00 | 9,90 | 300 | 116,30 TL |
| IRTU-POLM1011 | M8 | 8 | 15 | 15 | 40 | 40 | 1 | 3 | 2,50 | 8,80 | 100 | 151,00 TL |
| IRTU-POLM1012 | M10 | 10 | 15 | 15 | 40 | 40 | 1 | 3 | 2,70 | 8,90 | 100 | 151,20 TL |



960°C
30s

Çift Taraf Kör Somunlu SW 30 / H 30 / Two sided blind standoff insulators SW30/H30

| Kod / Code | Tip / Type | Ölçüler / Dimensions (mm) | | | | | Kullanım Voltajı ~ kV | Test Voltajı ~ kV | Gerilim Direnci kN | Ağırlık kg/1 box | Kutu Adedi / Box Qty. | Birim Fiyat Price (Adet/pcs) |
|-----------------|------------|---------------------------|----|----|----|----|-----------------------|-------------------|--------------------|------------------|-----------------------|------------------------------|
| | | a1 | b1 | b2 | SW | h | | | | | | |
| IRTU-POLM303006 | M6 | 6 | 11 | 11 | 30 | 30 | 1 | 3 | 4 | 6 | 200 | 124,70 TL |
| IRTU-POLM303008 | M8 | 8 | 11 | 11 | 30 | 30 | 1 | 3 | 6 | 6,20 | 200 | 126,40 TL |
| IRTU-POLM303010 | M10 | 10 | 11 | 11 | 30 | 30 | 1 | 3 | 6 | 6,50 | 200 | 137,20 TL |

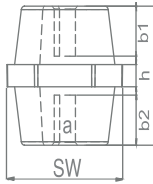

960°C
30s

Çift Taraf Kör Somunlu SW 40 / H 40 / Two sided blind standoff insulators SW 40/H 40

| Kod / Code | Tip / Type | Ölçüler / Dimensions (mm) | | | | | Kullanım Voltajı ~ kV | Test Voltajı ~ kV | Gerilim Direnci kN | Ağırlık kg/1 box | Kutu Adedi / Box Qty. | Birim Fiyat Price (Adet/pcs) |
|-----------------|------------|---------------------------|----|----|----|----|-----------------------|-------------------|--------------------|------------------|-----------------------|------------------------------|
| | | a1 | b1 | b2 | SW | h | | | | | | |
| IRTU-POLM404006 | M6 | 6 | 11 | 11 | 40 | 40 | 1 | 3 | 6 | 10 | 100 | 150,00 TL |
| IRTU-POLM404008 | M8 | 8 | 11 | 11 | 40 | 40 | 1 | 3 | 9 | 10,60 | 100 | 152,20 TL |
| IRTU-POLM404010 | M10 | 10 | 11 | 11 | 40 | 40 | 1 | 3 | 9 | 10,80 | 100 | 165,70 TL |

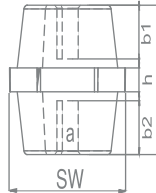

960°C
30s

Çift Taraf Kör Somunlu SW 50 / H 50 / Two sided blind standoff insulators S50/H50

| Kod / Code | Tip / Type | Ölçüler / Dimensions (mm) | | | | | Kullanım Voltajı ~ kV | Test Voltajı ~ kV | Gerilim Direnci kN | Ağırlık kg/1 box | Kutu Adedi / Box Qty. | Birim Fiyat Price (Adet/pcs) |
|---------------|------------|---------------------------|----|----|----|----|-----------------------|-------------------|--------------------|------------------|-----------------------|------------------------------|
| | | a1 | b1 | b2 | SW | h | | | | | | |
| IRTU-POLM1019 | M8 | 8 | 15 | 15 | 50 | 50 | 1 | 3 | 9 | 20,00 | 100 | 174,00 TL |
| IRTU-POLM1020 | M10 | 10 | 15 | 15 | 50 | 50 | 1 | 3 | 9 | 21,00 | 100 | 181,40 TL |
| IRTU-POLM1021 | M12 | 12 | 15 | 15 | 50 | 50 | 1 | 3 | 10 | 22,00 | 100 | 206,70 TL |

Çift Taraf Kör Somunlu SW 48 / H 76 / Two sided blind standoff insulators SW 48 / H 76

| Kod / Code | Tip / Type | Ölçüler / Dimensions (mm) | | | | | Kullanım Voltajı ~ kV | Test Voltajı ~ kV | Gerilim Direnci kN | Ağırlık kg/1 box | Kutu Adedi / Box Qty. | Birim Fiyat Price (Adet/pcs) |
|-----------------|------------|---------------------------|----|----|----|----|-----------------------|-------------------|--------------------|------------------|-----------------------|------------------------------|
| | | a1 | b1 | b2 | SW | h | | | | | | |
| IRTU-POLM487608 | M8 | 8 | 15 | 15 | 48 | 76 | 1 | 3 | 10 | 23,50 | 50 | 498,60 TL |
| IRTU-POLM487610 | M10 | 10 | 15 | 15 | 48 | 76 | 1 | 3 | 12 | 24,00 | 50 | 498,60 TL |
| IRTU-POLM487612 | M12 | 12 | 15 | 15 | 48 | 76 | 1 | 3 | 12 | 25,00 | 50 | 514,90 TL |

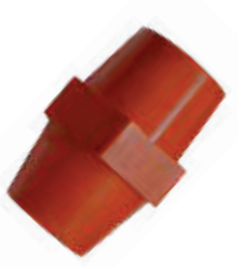
 960°C
30s

Çift Taraf Kör Somunlu 1N500 / Two sided blind standoff insulators 1N500

| Kod / Code | Tip / Type | Somun Ölçüsü Nut Measure (A) | Kullanım Voltajı ~ kV | Test Voltajı ~ kV | Gerilim Direnci kN | Ağırlık kg/18 pcs | Kutu Adedi / Box Qty. | Birim Fiyat Price (Adet/pcs) |
|---------------|------------|------------------------------|-----------------------|-------------------|--------------------|-------------------|-----------------------|------------------------------|
| IRTU-POLM1016 | 1N500 | M8 | 3 | 15 | 5,00 | 7,00 | 32 | 231,90 TL |
| IRTU-POLM1017 | 1N500 | M10 | 3 | 15 | 5,00 | 7,00 | 32 | 234,50 TL |
| IRTU-POLM1018 | 1N500 | M12 | 3 | 15 | 5,00 | 7,00 | 32 | 248,80 TL |

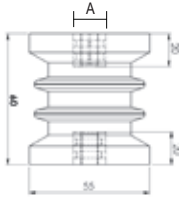
 960°C
30s

Çift Taraf Kör Somunlu / Two Sided Blind Standoff Insulators

| Kod / Code | Tip / Type | Kullanım Voltajı ~ kV | Test Voltajı ~ kV | Gerilim Direnci kN | Ağırlık kg/18 pcs | Kutu Adedi / Box Qty. | Birim Fiyat Price (Adet/pcs) |
|---------------|------------|-----------------------|-------------------|--------------------|-------------------|-----------------------|------------------------------|
| IRTU-POLM1013 | 1NMD-1 | 3 | 20 | 6,00 | 9,00 | 18 | 556,10 TL |

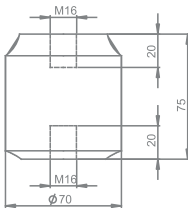
 960°C
30s



960°C
30s

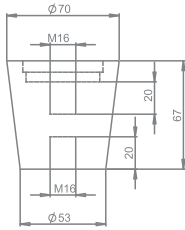

Çift Taraf Kör Somunlu / Two Sided Blind Standoff Insulators

| Kod / Code | Tip / Type | Kullanım Voltajı ~ kV | Test Voltajı ~ kV | Gerilim Direnci kN | Ağırlık kg/18 pcs | Kutu Adedi / Box Qty. | Birim Fiyat Price (Adet/pcs) |
|---------------|------------|-----------------------|-------------------|--------------------|-------------------|-----------------------|------------------------------|
| IRTU-POLM1014 | 1NMA-2 | 3 | 15 | 5,50 | 6,65 | 18 | 500,30 TL |



960°C
30s

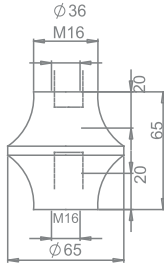

Çift Taraf Kör Somunlu / Two Sided Blind Standoff Insulators

| Kod / Code | Tip / Type | Kullanım Voltajı ~ kV | Test Voltajı ~ kV | Gerilim Direnci kN | Ağırlık kg/18 pcs | Kutu Adedi / Box Qty. | Birim Fiyat Price (Adet/pcs) |
|---------------|------------|-----------------------|-------------------|--------------------|-------------------|-----------------------|------------------------------|
| IRTU-POLM1015 | 1NMC-3 | 3 | 15 | 5,00 | 4,60 | 18 | 456,70 TL |

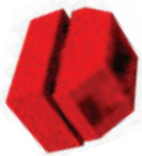

960°C
30s

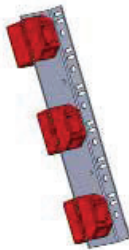

Bara İzolatörü / Busbar Insulator

| Kod / Code | Tip / Type | Kullanım Voltajı ~ kV | Test Voltajı ~ kV | Gerilim Direnci kN | Ağırlık gr / pcs | Kutu Adedi / Box Qty. | Birim Fiyat Price (Adet/pcs) |
|-----------------|------------|-----------------------|-------------------|--------------------|------------------|-----------------------|------------------------------|
| IRTU-POLM203858 | H:20mm | 3 | 15 | 5,00 | 0.150 | 50 | 341,00 TL |
| IRTU-POLM303858 | H:30mm | 3 | 15 | 5,00 | 0.175 | 50 | 365,50 TL |

- Dikeyde veya yatayda bakırları taşımak için kullanılır.
/ Product Used for carrying copper busbars vertically and horizontally.
- İzolatörler, bağlantı mesafelerine göre birbirinden bağımsız uygulanabilir.
/ Insulators can be applied independently according to connection span length and mounted to the main chassis with the sheet metal part.
- İzolatörler ana şaseye sac parça ile monte edilir.
/ Insulators are mounted onto the main chassis with a metal sheet part.

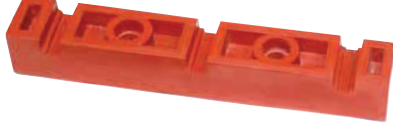
3x1F Tarak İzolatör / 3x1F Busbar Busbar Support Insulator

 960°C
 30s

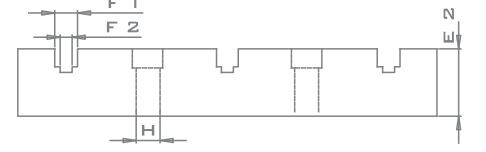
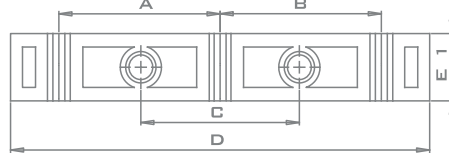
| Kod / Code | Tip / Type | Ölçüler / Dimensions (mm) | | | | | | | | | Min. Strength kN | Kutu Adedi / Box Qty | Birim Fiyat Unit Price (Adet/pcs) |
|---------------|--------------|---------------------------|------|----|-----|----|----|------|-----|-----|------------------|----------------------|-----------------------------------|
| | | A | B | C | D | E1 | E2 | F1 | F2 | H | | | |
| IRTU-POLT1002 | 3x1F/5-10 mm | 74,5 | 74,5 | 73 | 193 | 30 | 30 | 10,5 | 5,5 | Ø11 | 5 | 40 | 229,70 TL |

3x1F Tarak İzolatör / 3x1F Busbar Support Insulator

 960°C
 30s

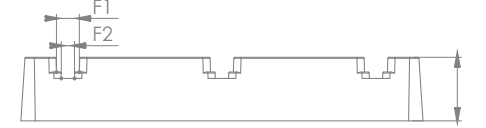
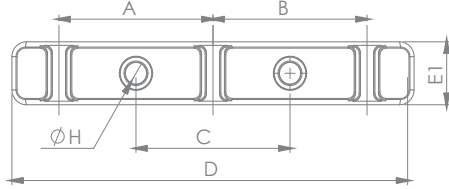
| Kod / Code | Tip / Type | Ölçüler / Dimensions (mm) | | | | | | | | | Min. Strength kN | Kutu Adedi / Box Qty | Birim Fiyat Unit Price (Adet/pcs) |
|---------------|--------------|---------------------------|----|----|-----|----|----|----|----|------|------------------|----------------------|-----------------------------------|
| | | A | B | C | D | E1 | E2 | F1 | F2 | H | | | |
| IRTU-POLT1012 | 3x1F/5-10 mm | 74 | 74 | 74 | 193 | 30 | 30 | 6 | 11 | Ø9,5 | 5 | 50 | 143,80 TL |

3x1F+N Tarak İzolatör / 3x1F+N Busbar Support Insulator

 960°C
 30s

| Kod / Code | Tip / Type | Ölçüler / Dimensions (mm) | | | | | | | | | Min. Strength kN | Kutu Adedi / Box Qty | Birim Fiyat Unit Price (Adet/pcs) |
|---------------|----------------|---------------------------|----|-----|----|----|----|----|------|---|------------------|----------------------|-----------------------------------|
| | | A | C | D | E1 | E2 | F1 | F2 | H | | | | |
| IRTU-POLT1013 | 3x1F+N/5-10 mm | 74 | 74 | 269 | 30 | 28 | 11 | 6 | Ø9,5 | 5 | 50 | 182,60 TL | |

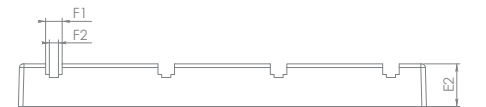
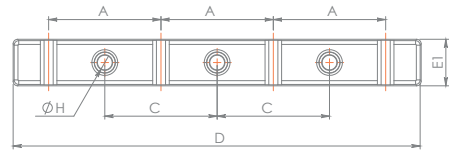



960°C
30s

3x1F+N Tarak İzolator / 3x1F+N Busbar Support Insulator

| Kod / Code | Tip / Type | Ölçüler / Dimensions (mm) | | | | | | | | Min. Strength kN | Kutu Adedi / Box Qty | Birim Fiyat Unit Price (Adet/pcs) |
|---------------|----------------|---------------------------|----|-----|----|------|------|-----|----|------------------|----------------------|-----------------------------------|
| | | A | C | D | E1 | E2 | F1 | F2 | H | | | |
| IRTU-POLT1005 | 3x1F+N/5-10 mm | 60 | 60 | 230 | 40 | 34,5 | 10,5 | 5,5 | Ø9 | 5 | 32 | 273,40 TL |

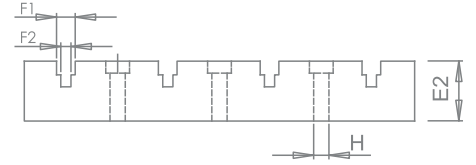
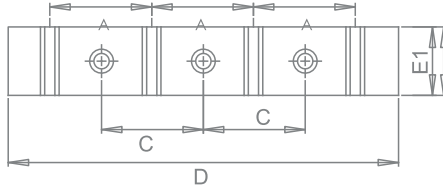

3x2F Tarak İzolator / 3x2F Busbar Support Insulators



960°C
30s

| Kod / Code | Tip / Type | Ölçüler / Dimensions (mm) | | | | | | | | Min. Strength kN | Kutu Adedi / Box Qty | Birim Fiyat Unit Price (Adet/pcs) |
|---------------|------------|---------------------------|------|-----|-----|----|----|------|-----|------------------|----------------------|-----------------------------------|
| | | A | B | C | D | E1 | E2 | F1 | H | | | |
| IRTU-POLT1007 | 3x2F/10 mm | 82 | 82 | 105 | 285 | 31 | 30 | 10,5 | Ø11 | 5 | 50 | 279,60 TL |
| IRTU-POLT1008 | 3x2F/5 mm | 91,5 | 91,5 | 105 | 285 | 31 | 30 | 5,5 | Ø11 | 5 | 50 | 279,60 TL |

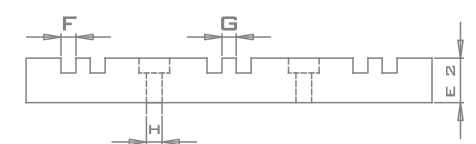
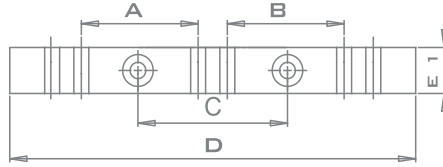

3x2F Tarak İzolator / 3x2F Busbar Support Insulator



960°C
30s

| Kod / Code | Tip / Type | Ölçüler / Dimensions (mm) | | | | | | | | Min. Strength kN | Kutu Adedi / Box Qty | Birim Fiyat Unit Price (Adet/pcs) | |
|---------------|--------------|---------------------------|----|-----|-----|----|----|------|-----|------------------|----------------------|-----------------------------------|-----------|
| | | A | B | C | D | E1 | E2 | F1 | F2 | | | | H |
| IRTU-POLT1015 | 3x2F/5-10 mm | 82 | 82 | 105 | 285 | 31 | 30 | 10,5 | 5,5 | Ø11 | 5 | 50 | 223,70 TL |

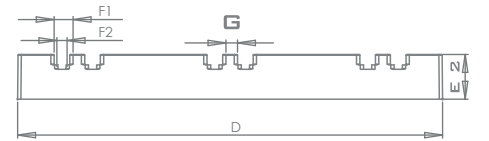
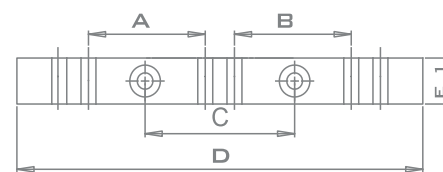

3x2F+N Tarak İzolator / 3x2F+N Busbar Support Insulator

 960°C
 30s

| Kod / Code | Tıp / Type | Ölçüler / Dimensions (mm) | | | | | | | | | | Min. Strength kN | Kutu Adedi / Box Qty | Birim Fiyat Unit Price (Adet/pcs) |
|---------------|----------------|---------------------------|----|------|-----|----|----|----------|------|------|---|------------------|----------------------|-----------------------------------|
| | | A1 | A2 | C | D | E1 | E2 | F1/F2 | G | H | | | | |
| IRTU-POLT1009 | 3x2F+N/5-10 mm | 20,5 | 65 | 85,5 | 303 | 31 | 30 | 10,5/5,5 | 54,5 | Ø8,5 | 5 | 50 | 483,00 TL | |

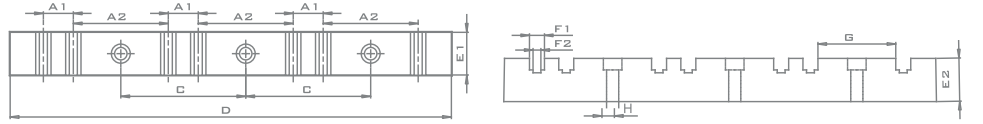
3x3F Tarak İzolator / 3x3F Busbar Support Insulator

 960°C
 30s

| Kod / Code | Tıp / Type | Ölçüler / Dimensions (mm) | | | | | | | | | | Min. Strength kN | Kutu Adedi / Box Qty | Birim Fiyat Unit Price (Adet/pcs) | |
|---------------|--------------|---------------------------|----|-------|-----|-----|----|----|------|-----|----|------------------|----------------------|-----------------------------------|-----------|
| | | A1 | A2 | C1 | C2 | D | E1 | E2 | F1 | F2 | G | | | | H |
| IRTU-POLT1010 | 3x3F/5-10 mm | 20,5 | 65 | 98,75 | 106 | 340 | 30 | 30 | 10,5 | 5,5 | 10 | Ø8,5 | 5 | 50 | 555,00 TL |

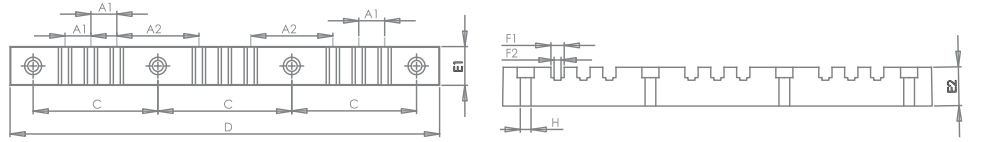

1x4F Tarak İzolator / 1x4F Busbar Support Insulator

 960°C
 30s

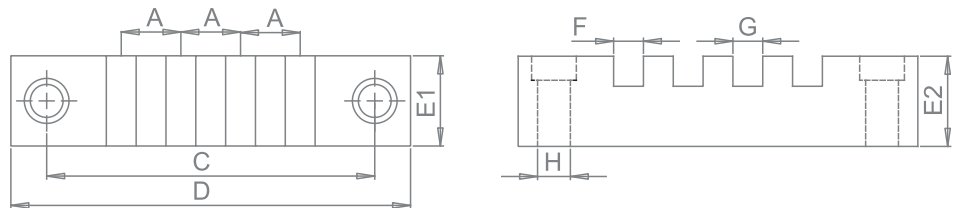
| Kod / Code | Tıp / Type | Ölçüler / Dimensions (mm) | | | | | | | Min. Direnç kN | Kutu Adedi / Box Qty | Birim Fiyat Unit Price (Adet/pcs) | |
|---------------|------------|---------------------------|-----|-----|----|----|------|------|----------------|----------------------|-----------------------------------|-----------|
| | | A | C | D | E1 | E2 | F1 | F2 | | | | H |
| IRTU-POLT1004 | 1x4F/5 mm | 22 | 110 | 134 | 31 | 29 | 5,5 | 10,5 | Ø9 | 5 | 50 | 151,00 TL |
| IRTU-POLT1001 | 1x4F/10 mm | 22 | 110 | 134 | 31 | 29 | 10,5 | 10,5 | Ø9 | 5 | 50 | 162,10 TL |

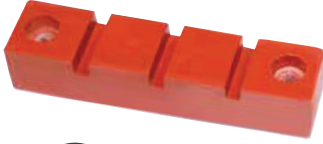

3x1FK Tarak İzolator / 3x1FK Busbar Support Insulator



960°C
30s

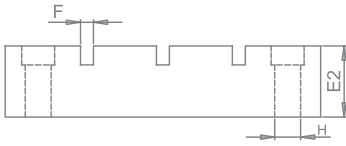

| Kod / Code | Tip / Type | Ölçüler / Dimensions (mm) | | | | | | | | Min. Direnç kN | Kutu Adedi / Box Qty | Birim Fiyat Unit Price (Adet/pcs) |
|---------------|------------------|---------------------------|-----|-----|----|----|-----|----|----|-------------------|-------------------------|---|
| | | A | C | D | E1 | E2 | F | G | H | | | |
| IRTU-POLT1003 | 3x1FK/5 mm Bakır | 33 | 110 | 134 | 31 | 29 | 5,5 | 27 | Ø9 | 5 | 50 | 142,90 TL |

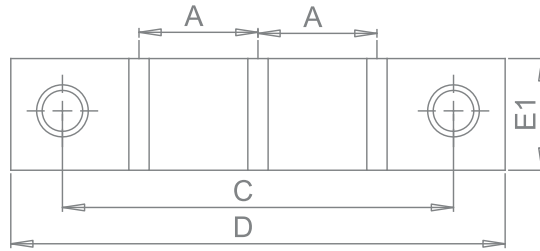

3x1FY+N Tarak İzolator / 3x1FY+N Busbar Support Insulator



960°C
30s

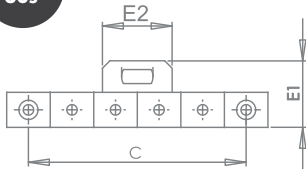

| Kod / Code | Tip / Type | Ölçüler / Dimensions (mm) | | | | | | | | Min. Direnç kN | Kutu Adedi / Box Qty | Birim Fiyat Unit Price (Adet/pcs) |
|---------------|------------|---------------------------|----|-----|-----|----|----|----|----|-------------------|-------------------------|---|
| | | A | B | C | D | E1 | E2 | F | H | | | |
| IRTU-POLT1006 | 3x1FY + N | 25 | 10 | 125 | 150 | 38 | 40 | 20 | Ø6 | 5 | 26 | 291,90 TL |

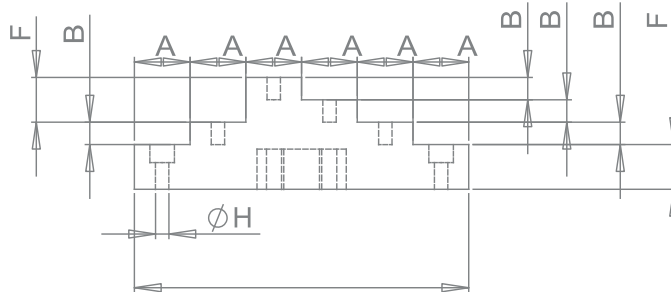

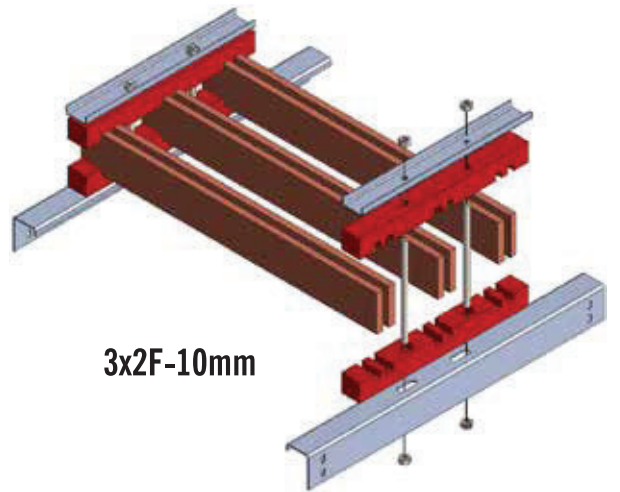
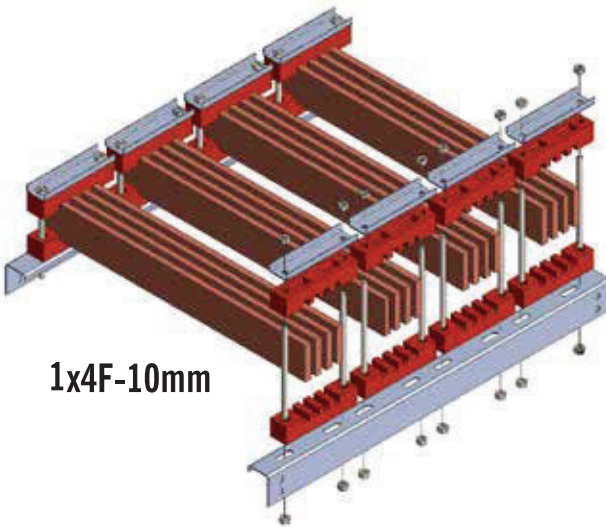
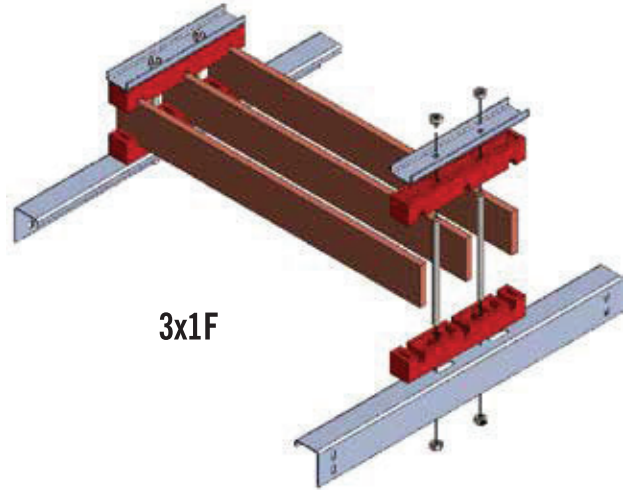
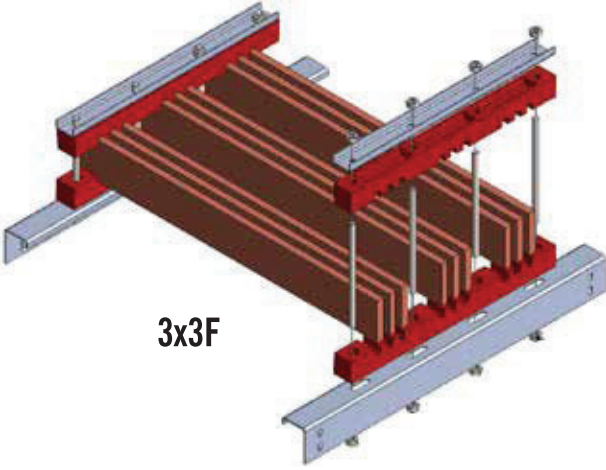
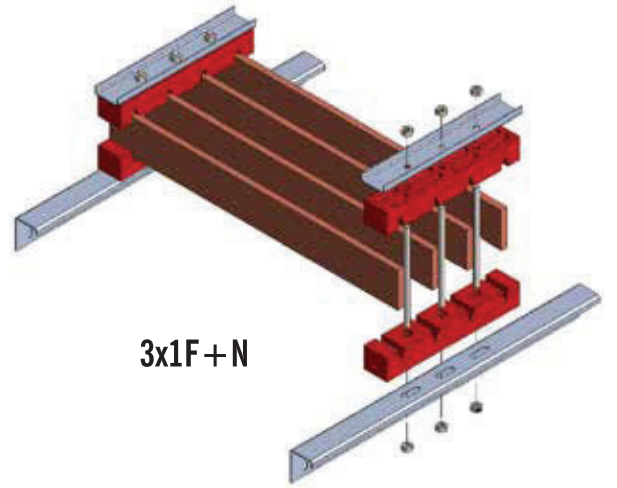
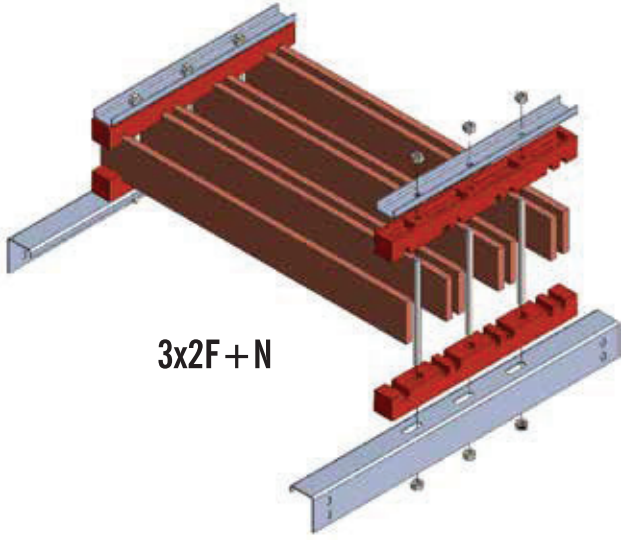

CAM ELYAF (UPGM 203) PLAKALAR

| Özellikler / Properties | Testler / Test Method | Birim / Unit |
|--|-------------------------|-------------------|
| Bükülme dayanıklılığı <i>Flexural strength across</i> | ISO 178 | MPa |
| Bükülme modülü <i>Flexural Modulus</i> | ISO 178 / IEC 60893-2 | MPa |
| İzod darbe dayanıklılığı <i>Izod impact strength paralell to laminations</i> | ISO 180 | Kj/m ² |
| Charpy darbe dayanıklılığı <i>Charpy impact strenght paralell to laminations</i> | ISO 179-1 / ISO 179-2 | Kj/m ² |
| Laminasyona dik 90° yağ içinde elektrik dayanıklılığı <i>Electric strenght at 90° in oil perpendicular to laminations</i> | IEC 60243-1 / IEC 60296 | kW/mm |
| Laminasyona dik 90° yağ içinde bozulma voltajı <i>Electric strenght at 90° in oil perpendicular to laminations</i> | IEC 60243-1 / IEC 60296 | kW/mm |
| Suya batırma sonrası izalasyon dayanımı <i>Insulation resistance after immersion in water</i> | IEC 60167 | M |

| Özellikler / Properties | Testler / Test Method | Birim / Unit |
|--|--------------------------------|-------------------|
| Karşılaştırmalı izleme endeksi <i>Proof tracking index</i> | IEC 60112 | CTI |
| İzleme ve aşında dayanımı <i>Tracking and erosion resistance</i> | IEC 60587 | Class |
| Yanmazlık <i>Flammability</i> | IEC 60695-10-11 IEC 60893-3 | UL94 |
| Kızaran tel <i>Glow wire</i> | TS EN 60695-2-13 | °C |
| Su emme <i>Water Absorption</i> | TS EN 60893-2 | Mg |
| Basınç dayanıklılığı <i>Compressive Strength</i> | TS EN ISO 604 | N/mm ² |
| Tüm yüzeye uygulanan basınç dayanıklılığı <i>Pressure strenght along across</i> | ISO 527 | N/mm ² |

Ürün Belgeleri / Certification

- Standard format
Standart format 800 mm x 1200 mm
- Materyal
Material UPGM, polyester reçine / cam elyaf mat 7735
UPGM, polyester resin / glass fiber mat 7735
- Üretim Modeli
Norm EN 60893 kapsamında UPGM 203 üretimi; DIN 7735: HM 2472
UPGM 203 according to EN 60893; HM 2472 according to DIN 7735
- Üretim Tipi
Type of production Sıkıştırma
Pressed
- Renk
Colour Standart Ral 7035 / İstenlen renk koduna göre üretim yapılmaktadır.
Standart color; Ral 7035 / given the color code, each color can be produced
- Kalınlık
Thickness 3 mm to 50 mm
- Uygun çalışma sıcaklığı
Working temperature -40 + 155 °C
-40 to + 155 °C
- Yoğunluk
Density 1.9 g/cm³

**960°C
KIZARAN
TEL TESTİ**

**50kA
TİP TESTİ**

**YÜZEYSEL
KAÇAK
TESTİ**

**MUKAYESE
DAYANIKLILIK
TESTİ**

**YOĞUNLUK
VE DARBE
TESTİ**

**DİELEKTRİK
TESTİ**

**CE
SERTİFİKASI**

Cam elyaf mat ve polyeester reçineden oluşan halojen gazı salgılamayan UPGM 203, hem elektriksel hem de mekanik alanlarda çok çeşitli uygulamalar için kullanılmaktadır. Yüksek mekanik ve termal özellikleri nedeniyle, F Sınıfı bir malzemenin gerekli olduğu elektrik panelleri, transformatörler ve daha fazlasının içinde kullanım için idealdir. Ürün, V0'a göre UL94 yanmazlık testine uygundur ve yalıtıklılık testine de sahiptir. Müşterilerimizin isteğine göre ürünü SMC veya el yatırması üretim yöntemleriyle üretebilmekteyiz.

Glass mat and unsaturated polyester resin bulk, special laminated halogen-free UPGM 203 is used for many kinds of both electrical and mechanical applications. Due to its excellent mechanical and thermal qualities it is used in electrical switchboards, transformers and many more, where a Class F material is a must. The product complies with UL94 flame resistance test to V0, as well as having a tracking test. UPGM 203 can be manufactured with both SMC and Hand Lay-up method in our factory.

UPGM 203 EL YATIRMASI / UPGM 203 HAND LAY UP

| Kod / Code | Ürün Tanımı / Product Name | Ölçüler / Dimension (mm) | | | Birim Fiyat / Unit Price (Adet/pcs) |
|-------------------|--|--------------------------|---------------|-----------------|-------------------------------------|
| | | Kalınlık Thickness (mm) | En Width (mm) | Boy Height (mm) | |
| IRTU-CEP038001200 | CAM ELYAF POLYESTER PLAKA FIBER GLASS PLATE | 3 | 800 | 1200 | 📄 |
| IRTU-CEP058001200 | | 5 | 800 | 1200 | 📄 |
| IRTU-CEP108001200 | | 10 | 800 | 1200 | 📄 |
| IRTU-CEP158001200 | | 15 | 800 | 1200 | 📄 |
| IRTU-CEP208001200 | | 20 | 800 | 1200 | 📄 |
| IRTU-CEP258001200 | | 25 | 800 | 1200 | 📄 |
| IRTU-CEP308001200 | | 30 | 800 | 1200 | 📄 |
| IRTU-CET030301200 | CAM ELYAF POLYESTER TAKOZ FIBER GLASS PLATE | 3 | 30 | 1200 | 📄 |
| IRTU-CET030401200 | | 3 | 40 | 1200 | 📄 |
| IRTU-CET030501200 | | 3 | 50 | 1200 | 📄 |
| IRTU-CET030601200 | | 3 | 60 | 1200 | 📄 |
| IRTU-CET050301200 | CAM ELYAF POLYESTER TAKOZ FIBER GLASS PLATE | 5 | 30 | 1200 | 📄 |
| IRTU-CET050401200 | | 5 | 40 | 1200 | 📄 |
| IRTU-CET050501200 | | 5 | 50 | 1200 | 📄 |
| IRTU-CET050601200 | | 5 | 60 | 1200 | 📄 |
| IRTU-CET100301200 | CAM ELYAF POLYESTER TAKOZ FIBER GLASS PLATE | 10 | 30 | 1200 | 📄 |
| IRTU-CET100401200 | | 10 | 40 | 1200 | 📄 |
| IRTU-CET100501200 | | 10 | 50 | 1200 | 📄 |
| IRTU-CET100601200 | | 10 | 60 | 1200 | 📄 |
| IRTU-CET150301200 | CAM ELYAF POLYESTER TAKOZ FIBER GLASS PLATE | 15 | 30 | 1200 | 📄 |
| IRTU-CET150401200 | | 15 | 40 | 1200 | 📄 |
| IRTU-CET150501200 | | 15 | 50 | 1200 | 📄 |
| IRTU-CET150601200 | | 15 | 60 | 1200 | 📄 |
| IRTU-CET200301200 | CAM ELYAF POLYESTER TAKOZ FIBER GLASS PLATE | 20 | 30 | 1200 | 📄 |
| IRTU-CET200401200 | | 20 | 40 | 1200 | 📄 |
| IRTU-CET200501200 | | 20 | 50 | 1200 | 📄 |
| IRTU-CET200601200 | | 20 | 60 | 1200 | 📄 |
| IRTU-CET250301200 | CAM ELYAF POLYESTER TAKOZ FIBER GLASS PLATE | 25 | 30 | 1200 | 📄 |
| IRTU-CET250401200 | | 25 | 40 | 1200 | 📄 |
| IRTU-CET250501200 | | 25 | 50 | 1200 | 📄 |
| IRTU-CET250601200 | | 25 | 60 | 1200 | 📄 |
| IRTU-CET300301200 | CAM ELYAF POLYESTER TAKOZ FIBER GLASS PLATE | 30 | 30 | 1200 | 📄 |
| IRTU-CET300401200 | | 30 | 40 | 1200 | 📄 |
| IRTU-CET300501200 | | 30 | 50 | 1200 | 📄 |
| IRTU-CET300601200 | | 30 | 60 | 1200 | 📄 |
| IRTU-CET500301200 | CAM ELYAF POLYESTER TAKOZ FIBER GLASS PLATE | 50 | 30 | 1200 | 📄 |
| IRTU-CET500401200 | | 50 | 40 | 1200 | 📄 |
| IRTU-CET500501200 | | 50 | 50 | 1200 | 📄 |
| IRTU-CET500601200 | | 50 | 60 | 1200 | 📄 |





UPGM 203 SMC ÜRETİM / UPGM 203 SMC PRODUCTION

| Kod / Code | Ürün Tanımı / Product Name | Ölçüler / Dimensian (mm) | | | Birim Fiyat / Unit Price (Adet/pcs) |
|--------------------|--|--------------------------|---------------|-----------------|-------------------------------------|
| | | Kalınlık Thickness (mm) | En Width (mm) | Boy Height (mm) | |
| IRTU-SMCP038001200 | SMC POLYESTER PLAKA SMC FIBER GLASS PLATE | 3 | 800 | 1200 | 📄 |
| IRTU-SMCP058001200 | | 5 | 800 | 1200 | 📄 |
| IRTU-SMCP108001200 | | 10 | 800 | 1200 | 📄 |
| IRTU-SMCP158001200 | | 15 | 800 | 1200 | 📄 |
| IRTU-SMCP208001200 | | 20 | 800 | 1200 | 📄 |
| IRTU-SMCP258001200 | | 25 | 800 | 1200 | 📄 |
| IRTU-SMCP308001200 | | 30 | 800 | 1200 | 📄 |
| IRTU-SMCT030301200 | SMC POLYESTER TAKOZ SMC FIBER GLASS PLATE | 3 | 30 | 1200 | 📄 |
| IRTU-SMCT030401200 | | 3 | 40 | 1200 | 📄 |
| IRTU-SMCT030501200 | | 3 | 50 | 1200 | 📄 |
| IRTU-SMCT030601200 | | 3 | 60 | 1200 | 📄 |
| IRTU-SMCT050301200 | SMC POLYESTER TAKOZ SMC FIBER GLASS PLATE | 5 | 30 | 1200 | 📄 |
| IRTU-SMCT050401200 | | 5 | 40 | 1200 | 📄 |
| IRTU-SMCT050501200 | | 5 | 50 | 1200 | 📄 |
| IRTU-SMCT050601200 | | 5 | 60 | 1200 | 📄 |
| IRTU-SMCT100301200 | SMC POLYESTER TAKOZ SMC FIBER GLASS PLATE | 10 | 30 | 1200 | 📄 |
| IRTU-SMCT100401200 | | 10 | 40 | 1200 | 📄 |
| IRTU-SMCT100501200 | | 10 | 50 | 1200 | 📄 |
| IRTU-SMCT100601200 | | 10 | 60 | 1200 | 📄 |
| IRTU-SMCT150301200 | SMC POLYESTER TAKOZ SMC FIBER GLASS PLATE | 15 | 30 | 1200 | 📄 |
| IRTU-SMCT150401200 | | 15 | 40 | 1200 | 📄 |
| IRTU-SMCT150501200 | | 15 | 50 | 1200 | 📄 |
| IRTU-SMCT150601200 | | 15 | 60 | 1200 | 📄 |
| IRTU-SMCT200301200 | SMC POLYESTER TAKOZ SMC FIBER GLASS PLATE | 20 | 30 | 1200 | 📄 |
| IRTU-SMCT200401200 | | 20 | 40 | 1200 | 📄 |
| IRTU-SMCT200501200 | | 20 | 50 | 1200 | 📄 |
| IRTU-SMCT200601200 | | 20 | 60 | 1200 | 📄 |
| IRTU-SMCT250301200 | SMC POLYESTER TAKOZ SMC FIBER GLASS PLATE | 25 | 30 | 1200 | 📄 |
| IRTU-SMCT250401200 | | 25 | 40 | 1200 | 📄 |
| IRTU-SMCT250501200 | | 25 | 50 | 1200 | 📄 |
| IRTU-SMCT250601200 | | 25 | 60 | 1200 | 📄 |
| IRTU-SMCT300301200 | SMC POLYESTER TAKOZ SMC FIBER GLASS PLATE | 30 | 30 | 1200 | 📄 |
| IRTU-SMCT300401200 | | 30 | 40 | 1200 | 📄 |
| IRTU-SMCT300501200 | | 30 | 50 | 1200 | 📄 |
| IRTU-SMCT300601200 | | 30 | 60 | 1200 | 📄 |
| IRTU-SMCT500301200 | SMC POLYESTER TAKOZ SMC FIBER GLASS PLATE | 50 | 30 | 1200 | 📄 |
| IRTU-SMCT500401200 | | 50 | 40 | 1200 | 📄 |
| IRTU-SMCT500501200 | | 50 | 50 | 1200 | 📄 |
| IRTU-SMCT500601200 | | 50 | 60 | 1200 | 📄 |





UPGM 203 CAM ELYAF PLAKA

UPGM 203 FIBER GLASS PLATE

Cam elyaf mat ve polyester reçineden dluşan halojen gazı salgılamayan UPGM 203, hem elektriksel hem de mekanik alanlarda çok çeşitli uygulamalar için kullanılmaktadır. Yüksek mekanik ve termal özellikleri nedeniyle, F Sınıf bir malzemenin gerekli olduğu elektrik panelleri, transformatörler ve daha fazlasının içinde kullanım için idealdir. Ürün. V0'a göre UL94 yanmazlık testine uygundur ve yalıtkanlık testine de sahiptir. Müşterilerimizin isteğine göre ürünü SMC veya el yatırması üretim yöntemleriyle üretebilmekteyiz.

UPGM 203, composed of fiber glass mat and unsaturated polyester resin bulk is specially laminated and halogen free. Due to its excellent electrical and mechanical applications, it is used in electrical switchboards, transformers and many more, where a Class F material is a must. The product complies with UL 94 flame resistance test to V0, as well as having a tracking test. UPGM 203 can be manufactured with both SMC and Hand Lay-up method in our factory.

OG İZOLATÖRLER VE EKİPMALARI



OG İZOLATÖRLER

- Dahili Tip Mesnet İzolatörler
- Kapasitif Gerilim İzolatörler



TRAFO BUSHING

- Yağlı Tip Dağıtım ve Güç Trafolarında, Bushing altında kullanılır.
- 250A - 450A AG Bushing İzolatör



KABLO TUTUCULAR

- Hücre İçi Kablo Tutucu
- Kablo Taşıma Askısı



KABLO KÖRÜK

- Hücre İçi Kablo Köprüğü
- 180 x 64 mm Plastik Köprü

Dahili Tip O.G Mesnet İzolatörü / Post Insulators

| Kod / Code | Tip / Type | | Um (kV) | Min. Bükme Min. Bending | Ölçüler / Measurement | | | | | | | | | | Min. Krepaj mm | Perde Sheds | Birim Fiyatı / Price (Adet / PCS) |
|------------|------------|----------|---------|-------------------------|-----------------------|-----|----|-----|-----|-----|-----|----|----|----|----------------|-------------|-----------------------------------|
| | VDE | IEC | | | N | H | e | D | a | b | c | t1 | t2 | t3 | | | |
| IRTU-M1002 | 10 N 500 | JO4-75 | 12 | 4000 | 130 | 36 | 62 | M16 | M12 | M6 | 24 | 15 | 14 | 36 | 160 | 5 | |
| IRTU-M1003 | 10 N 1000 | JO8-75 | | | 8000 | 130 | 46 | 80 | M20 | M16 | M10 | 27 | 33 | 15 | 42 | 187 | |
| IRTU-M2001 | 20 N 500 | JO4-125 | 24 | 4000 | 130 | 36 | 74 | M16 | M12 | M6 | 33 | 15 | 14 | 50 | 320 | 8 | |
| IRTU-M2002 | 20 N 1000 | JO8-125 | | | 8000 | 210 | 46 | 86 | M20 | M16 | M10 | 27 | 33 | 15 | 44 | 320 | |
| IRTU-M3001 | 30 N 500 | JO4-170 | 36 | 4000 | 300 | 36 | 76 | M16 | M12 | M6 | 33 | 15 | 14 | 54 | 445 | 11 | |
| IRTU-M3002 | 30 N 1000 | JO10-170 | | | 10000 | 300 | 46 | 99 | M24 | M16 | M10 | 36 | 33 | 15 | 60 | 445 | |

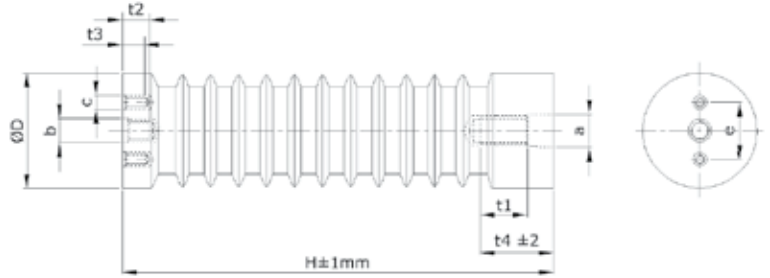
Dahili Tip Orta Gerilim Kapasitip Gerilim Mesnet İzolatörler / Voltage Divider Post Insulator

| Kod / Code | Tip / Type | Um (kV) | Min. Bükme Min. Bending | Ölçüler / Measurement | | | | | | | | | | Min. Krepaj mm | Perde Sheds | Birim Fiyatı / Price (Adet / PCS) | |
|-------------|------------|---------|-------------------------|-----------------------|-----|----|----|-----|-----|-----|----|----|----|----------------|-------------|-----------------------------------|----|
| | | | | N | H | e | D | s | a | b | v | t1 | t2 | | | | t3 |
| IRTU-DG1201 | 10 N 10000 | 12 | 8000 | 130 | 46 | 80 | 30 | M20 | M16 | M10 | 17 | 20 | 17 | 20 | 160 | 5 | |
| IRTU-DG2401 | 20 N 500 | | | 4000 | 210 | 36 | 74 | 30 | M20 | M12 | M6 | 35 | 20 | 14 | 47 | 320 | |
| IRTU-DG2402 | 20 N 10000 | 24 | 8000 | 210 | 46 | 86 | 30 | M16 | M16 | M10 | 35 | 27 | 20 | 47 | 320 | 8 | |
| IRTU-DG3601 | 30 N 500 | | | 4000 | 300 | 36 | 82 | 34 | M24 | M12 | M6 | 19 | 22 | 17 | 50 | 435 | |
| IRTU-DG3602 | 30 N 1000 | 36 | 8000 | 300 | 46 | 99 | 34 | M24 | M16 | M10 | 36 | 21 | 17 | 57 | 435 | 11 | |

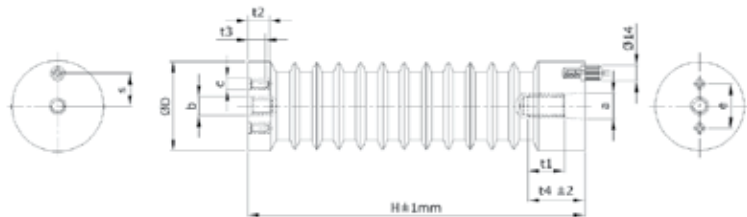



- Yağlı tip dağıtım ve güç trafolarında bushing altı kullanılır.
Used in oiled type distribution and power transformers.
- Plastik malzemeden üretilmektedir.
Made of plastic material.



| Kod / Code | Tip / Type | Ürün Tanımı / Product Name | Kutu Adedi / Box Qty | Birim Fiyat Price (Adet/pcs) |
|-------------|------------|----------------------------|----------------------|------------------------------|
| IRTU-BS250 | DT 250 | 250AAG Bushing İzolatör | 100 | |
| IRTU-BS630 | DT 630 | 630AAG Bushing İzolatör | 100 | |
| IRTU-BS1000 | DT 1000 | 1000AAG Bushing İzolatör | 100 | |
| IRTU-BS2000 | DT 2000 | 2000AAG Bushing İzolatör | 100 | |
| IRTU-BS3150 | DT 3150 | 3150AAG Bushing İzolatör | 100 | |
| IRTU-BS4500 | DT 4500 | 4500AAG Bushing İzolatör | 100 | |

Orta Gerilim Hücre Kablo Körüğü / Medium Voltage Switchhears Cable Bellows



| Kod / Code | Ürün Tanımı / Product Name | Kutu Adedi / Box Qty | Birim Fiyat / Unit Price (adet/pcs) |
|---------------|--|----------------------|-------------------------------------|
| IRTU-PKT 1040 | Ø60 mm Plastik Kablo Köpüğü / Plastic Cable Bellows | 100 | 80,90 TL |
| IRTU-PKT 1030 | Ø100 mm Plastik Kablo Köpüğü / Plastic Cable Bellows | 120 | 107,80 TL |

- Orta gerilim hücre içinde kablo girişlerinde sızırmalara karşı kullanılır. / Used in MV cable entries against leaks

Körük / Bellows



| Kod / Code | Ürün Tanımı / Product Name | Kutu Adedi / Box Qty | Birim Fiyat / Unit Price (adet/pcs) |
|-----------------|---|----------------------|-------------------------------------|
| IRTU-PKT1050 | Plastik Körük / Plastic Bellows (180x64mm) | 60 | 218,40 TL |
| IRTU-PKT1050 VO | Plastik Körük Yanmaz (VO) / Plastic Bellows Fireproof (VO) (180x64mm) | 60 | 339,30 TL |

KabloTaşıma Askısı / Cable Carriers



| Kod / Code | Ürün Tanımı / Product Name | Kutu Adedi / Box Qty | Birim Fiyat / Unit Price (adet/pcs) |
|------------|--|----------------------|-------------------------------------|
| IRTU-7001 | 80'lik Kablo Taşıma Askısı / Cable Carrier | 50 | 204,40 TL |

- Dahili ortam ve tünel içi kablo taşıma olarak kullanılır. / Used as an indoor and tunnel cable carrier.
- Birbirine geçme monteli çoğaltılarak kullanılabilir. / Can be used by duplicating interlocking mounted.
- Plastik ve yanmaz özelliklidir. / Plastic and inflammable.

Orta Gerilim Hücre Kablo Tutucu / Medium Voltage Switchhears Cable Holder



| Kod / Code | Ürün Tanımı / Product Name | Kutu Adedi / Takım / Box Qty | Birim Fiyat / Unit Price (adet/pcs) |
|--------------|---|------------------------------|-------------------------------------|
| IRTU-PKT1020 | Plastik Kablo Tutucu / Plastic Cable Holder | 50 | 170,60 TL |

- Orta gerilim hücre içinde kablo girişlerinde kullanılır. / Used in MV cable entries.
- Yanmaz ve halogen-free özelliklidir. / Inflammable and halogen-free
- Ø 50-80 mm kabloya uygundur. / Compatible for Ø 50-80 mm cable.

DAĞITIM ÜRÜNLERİ VE TOPRAKLAMA ÇÖZÜMLERİ

DAĞITIM ÜNİTELERİ



- 80A - 125A - 160A - 200A - 250A.
- Tek, İki, Üç ve Dört Kutuplu Üniteler.
- Monoblock Güç Dağıtım Blokları.

BAĞLANTI KLEMENSLERİ

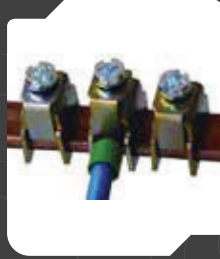

- Bakır Bağlantı Klemensleri.
- Geçmeli Bağlantı Klemensleri.
- Yay Baskılı Bağlantı Klemensleri.
- U Klemensler.
- Kapı Topraklama Baraları.

TOPRAKLAMA KLEMENSLERİ



- 80A - 125A - 160A.
- Topraklama Klemensleri (Ayaksız).
- Nötr Klemensler (Ayaklı).
- İzolasyonlu Topraklama Klemensleri.

TOPRAKLAMA BARALARI

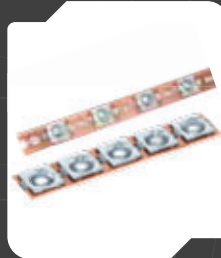

- Bakır Topraklama Baraları.
- Vidalı Bara Mesnetleri.
- Plastik Ayaklı Topraklama Barası.
- Eş Potansiyel Baralar.

OTOMAT BARALARI

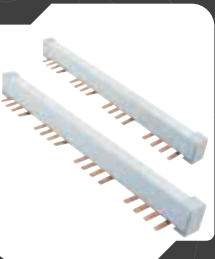

- Monofaze Otomat Baraları.
- İki Fazlı Otomat Baraları.
- Trifaze Otomat Baraları.
- Üç Faz + Nötr Otomat Baraları.
- L1+N - L2+N - L3+N Baralar.
- Motor Koruma Baraları.

BAĞLANTI BARALARI

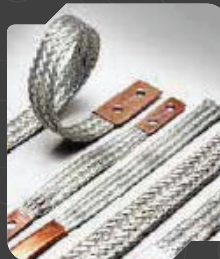

- Flexi Bağlantı Baraları.
- İzole Örgülü Bağlantı Baraları.
- İzoleli Esnek Baralar.

80A Tek Kutuplu Dağıtım Ünitesi (6,5x9 mm) / 80A One Pole Distribution Unit (6,5x9 mm)

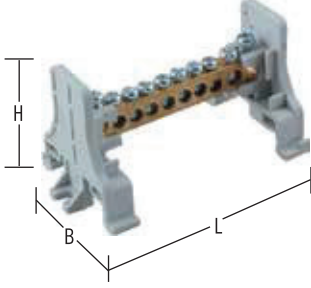

| Kod / Code | Ürün Tanımı / Product Name | L | B | H | Koli Adedi / Box Qty. | Birim Fiyat / Unit Price (Adet/pcs) |
|-------------|--|-----|----|----|-----------------------|-------------------------------------|
| IRTU-550204 | 2+4 6 DELİKLİ ÜNİTE / 2+4 6 HOLE UNITS | 60 | 42 | 44 | 125 | 156,80 TL |
| IRTU-550205 | 2+5 7 DELİKLİ ÜNİTE / 2+5 7 HOLE UNITS | 66 | 42 | 44 | 120 | 174,80 TL |
| IRTU-550208 | 2+8 10 DELİKLİ ÜNİTE / 2+8 10 HOLE UNITS | 82 | 42 | 44 | 100 | 192,90 TL |
| IRTU-550210 | 2+10 12 DELİKLİ ÜNİTE / 2+10 12 HOLE UNITS | 100 | 42 | 44 | 90 | 230,90 TL |
| IRTU-550213 | 2+13 15 DELİKLİ ÜNİTE / 2+13 15 HOLE UNITS | 115 | 42 | 44 | 75 | 256,50 TL |
| IRTU-550218 | 2+18 20 DELİKLİ ÜNİTE / 2+18 20 HOLE UNITS | 142 | 42 | 44 | 50 | 364,80 TL |
| IRTU-550223 | 2+23 25 DELİKLİ ÜNİTE / 2+23 25 HOLE UNITS | 175 | 42 | 44 | 40 | 465,50 TL |
| IRTU-550228 | 2+28 30 DELİKLİ ÜNİTE / 2+28 30 HOLE UNITS | 215 | 42 | 44 | 30 | 538,70 TL |

80A Tek Kutuplu Kapaklı Dağıtım Ünitesi (6,5x9 mm) / 80A One Pole Covered Distribution Unit (6,5x9 mm)



| Kod / Code | Ürün Tanımı / Product Name | L | B | H | Koli Adedi / Box Qty. | Birim Fiyat / Unit Price (Adet/pcs) |
|-------------|--|-----|----|----|-----------------------|-------------------------------------|
| IRTU-551204 | 2+4 6 DELİKLİ ÜNİTE / 2+4 6 HOLE UNITS | 60 | 42 | 44 | 110 | 180,50 TL |
| IRTU-551205 | 2+5 7 DELİKLİ ÜNİTE / 2+5 7 HOLE UNITS | 66 | 42 | 44 | 100 | 194,80 TL |
| IRTU-551208 | 2+8 10 DELİKLİ ÜNİTE / 2+8 10 HOLE UNITS | 82 | 42 | 44 | 80 | 256,50 TL |
| IRTU-551210 | 2+10 12 DELİKLİ ÜNİTE / 2+10 12 HOLE UNITS | 100 | 42 | 44 | 70 | 295,00 TL |
| IRTU-551213 | 2+13 15 DELİKLİ ÜNİTE / 2+13 15 HOLE UNITS | 115 | 42 | 44 | 50 | 364,80 TL |
| IRTU-551218 | 2+18 20 DELİKLİ ÜNİTE / 2+18 20 HOLE UNITS | 142 | 42 | 44 | 40 | 448,40 TL |
| IRTU-551223 | 2+23 25 DELİKLİ ÜNİTE / 2+23 25 HOLE UNITS | 175 | 42 | 44 | 30 | 475,00 TL |
| IRTU-551228 | 2+28 30 DELİKLİ ÜNİTE / 2+28 30 HOLE UNITS | 215 | 42 | 44 | 20 | 537,70 TL |

80A 2 Kutuplu Dağıtım Ünitesi (6,5x9 mm) / 80A 2 Pole Distribution Unit (6,5x9 mm)



| Kod / Code | Ürün Tanımı / Product Name | L | B | H | Koli Adedi / Box Qty. | Birim Fiyat / Unit Price (Adet/pcs) |
|-------------|----------------------------|-----|----|----|-----------------------|-------------------------------------|
| IRTU-650205 | 2+5 DELİKLİ / 2+5 HOLE | 65 | 45 | 47 | 22 | 345,60 TL |
| IRTU-650208 | 2+8 DELİKLİ / 2+8 HOLE | 88 | 45 | 47 | 15 | 409,60 TL |
| IRTU-650210 | 2+10 DELİKLİ / 2+10 HOLE | 102 | 45 | 47 | 14 | 443,20 TL |
| IRTU-650213 | 2+13 DELİKLİ / 2+13 HOLE | 126 | 45 | 47 | 12 | 584,00 TL |
| IRTU-650218 | 2+18 DELİKLİ / 2+18 HOLE | 162 | 45 | 47 | 6 | 755,20 TL |
| IRTU-650220 | 2+20 DELİKLİ / 2+20 HOLE | 175 | 45 | 47 | 6 | 788,80 TL |

80A 4 Kutuplu Dağıtım Ünitesi (6,5x9 mm) / 80A 4 Pole Distribution Unit (6,5x9 mm)



| Kod / Code | Ürün Tanımı / Product Name | L | B | H | Koli Adedi / Box Qty. | Birim Fiyat / Unit Price (Adet/pcs) |
|-------------|----------------------------|-----|----|----|-----------------------|-------------------------------------|
| IRTU-651205 | 2+5 DELİKLİ / 2+5 HOLE | 65 | 90 | 50 | 10 | 648,00 TL |
| IRTU-651208 | 2+8 DELİKLİ / 2+8 HOLE | 87 | 90 | 50 | 8 | 691,20 TL |
| IRTU-651210 | 2+10 DELİKLİ / 2+10 HOLE | 102 | 90 | 50 | 6 | 760,00 TL |
| IRTU-651213 | 2+13 DELİKLİ / 2+13 HOLE | 126 | 90 | 50 | 5 | 963,20 TL |
| IRTU-651218 | 2+18 DELİKLİ / 2+18 HOLE | 162 | 90 | 50 | 4 | 1.036,80 TL |
| IRTU-651220 | 2+20 DELİKLİ / 2+20 HOLE | 175 | 90 | 50 | 4 | 1.360,00 TL |
| IRTU-651223 | 2+23 DELİKLİ / 2+23 HOLE | 197 | 90 | 50 | 4 | 1.536,00 TL |

125A Tek Kutuplu Dağıtım Ünitesi (7x12 mm) / 125A One Pole Distribution Unit (7x12 mm)



| Kod / Code | Ürün Tanımı / Product Name | L | B | H | Koli Adedi / Box Qty. | Birim Fiyat / Unit Price (Adet/pcs) |
|-------------|--|-----|----|----|-----------------------|-------------------------------------|
| IRTU-730205 | 2+5 7 DELİKLİ ÜNİTE / 2+5 7 HOLE UNITS | 76 | 44 | 42 | 65 | 205,20 TL |
| IRTU-730208 | 2+8 10 DELİKLİ ÜNİTE / 2+8 10 HOLE UNITS | 100 | 44 | 42 | 48 | 220,40 TL |
| IRTU-730210 | 2+10 12 DELİKLİ ÜNİTE / 2+10 12 HOLE UNITS | 115 | 44 | 42 | 45 | 243,20 TL |
| IRTU-730213 | 2+13 15 DELİKLİ ÜNİTE / 2+13 15 HOLE UNITS | 135 | 44 | 42 | 40 | 372,40 TL |
| IRTU-730218 | 2+18 20 DELİKLİ ÜNİTE / 2+18 20 HOLE UNITS | 170 | 44 | 42 | 30 | 448,40 TL |
| IRTU-730220 | 2+20 22 DELİKLİ ÜNİTE / 2+20 22 HOLE UNITS | 185 | 44 | 42 | 30 | 502,60 TL |
| IRTU-730223 | 2+23 25 DELİKLİ ÜNİTE / 2+23 25 HOLE UNITS | 207 | 44 | 42 | 25 | 538,70 TL |
| IRTU-730228 | 2+28 30 DELİKLİ ÜNİTE / 2+28 30 HOLE UNITS | 245 | 44 | 42 | 20 | 620,40 TL |

125A Tek Kutuplu Kapaklı Dağıtım Ünitesi (7x12 mm) / 125A One Pole Covered Distribution Unit (7x12 mm)



| Kod / Code | Ürün Tanımı / Product Name | L | B | H | Koli Adedi / Box Qty. | Birim Fiyat / Unit Price (Adet/pcs) |
|-------------|--|-----|----|----|-----------------------|-------------------------------------|
| IRTU-731205 | 2+5 7 DELİKLİ ÜNİTE / 2+5 7 HOLE UNITS | 76 | 44 | 42 | 75 | 230,90 TL |
| IRTU-731208 | 2+8 10 DELİKLİ ÜNİTE / 2+8 10 HOLE UNITS | 100 | 44 | 42 | 60 | 269,80 TL |
| IRTU-731210 | 2+10 12 DELİKLİ ÜNİTE / 2+10 12 HOLE UNITS | 115 | 44 | 42 | 50 | 307,80 TL |
| IRTU-731213 | 2+13 15 DELİKLİ ÜNİTE / 2+13 15 HOLE UNITS | 135 | 44 | 42 | 40 | 393,30 TL |
| IRTU-731218 | 2+18 20 DELİKLİ ÜNİTE / 2+18 20 HOLE UNITS | 170 | 44 | 42 | 30 | 486,40 TL |
| IRTU-731220 | 2+20 22 DELİKLİ ÜNİTE / 2+20 22 HOLE UNITS | 185 | 44 | 42 | 30 | 539,60 TL |
| IRTU-731223 | 2+23 25 DELİKLİ ÜNİTE / 2+23 25 HOLE UNITS | 207 | 44 | 42 | 20 | 621,30 TL |
| IRTU-731228 | 2+28 30 DELİKLİ ÜNİTE / 2+28 30 HOLE UNITS | 245 | 44 | 42 | 20 | 712,50 TL |

125A 2 Kutuplu Dağıtım Ünitesi (7x12 mm) / 125A 2 Pole Distribution Unit (7x12 mm)



| Kod / Code | Ürün Tanımı / Product Name | L | B | H | Koli Adedi / Box Qty. | Birim Fiyat / Unit Price (Adet/pcs) |
|-------------|----------------------------|-----|----|----|-----------------------|-------------------------------------|
| IRTU-720205 | 2+5 DELİKLİ / 2+5 HOLE | 65 | 45 | 47 | 22 | 400,00 TL |
| IRTU-720208 | 2+8 DELİKLİ / 2+8 HOLE | 88 | 45 | 47 | 15 | 432,00 TL |
| IRTU-720210 | 2+10 DELİKLİ / 2+10 HOLE | 102 | 45 | 47 | 14 | 480,00 TL |
| IRTU-720213 | 2+13 DELİKLİ / 2+13 HOLE | 126 | 45 | 47 | 12 | 616,00 TL |
| IRTU-720218 | 2+18 DELİKLİ / 2+18 HOLE | 162 | 45 | 47 | 6 | 771,20 TL |
| IRTU-720220 | 2+20 DELİKLİ / 2+20 HOLE | 175 | 45 | 47 | 6 | 843,20 TL |

125A 4 Kutuplu Dağıtım Ünitesi (7x12 mm) / 125A 4 Pole Distribution Unit (7x12 mm)



| Kod / Code | Ürün Tanımı / Product Name | L | B | H | Koli Adedi / Box Qty. | Birim Fiyat / Unit Price (Adet/pcs) |
|-------------|----------------------------|-----|----|----|-----------------------|-------------------------------------|
| IRTU-741205 | 2+5 DELİKLİ / 2+5 HOLE | 65 | 90 | 50 | 29 | 745,20 TL |
| IRTU-741208 | 2+8 DELİKLİ / 2+8 HOLE | 87 | 90 | 50 | 16 | 810,00 TL |
| IRTU-741210 | 2+10 DELİKLİ / 2+10 HOLE | 102 | 90 | 50 | 12 | 896,40 TL |
| IRTU-741213 | 2+13 DELİKLİ / 2+13 HOLE | 126 | 90 | 50 | 10 | 1.112,00 TL |
| IRTU-741218 | 2+18 DELİKLİ / 2+18 HOLE | 162 | 90 | 50 | 8 | 1.447,20 TL |
| IRTU-741220 | 2+20 DELİKLİ / 2+20 HOLE | 175 | 90 | 50 | 8 | 1.544,40 TL |
| IRTU-741223 | 2+23 DELİKLİ / 2+23 HOLE | 197 | 90 | 50 | 8 | 1.781,60 TL |

125A 4 Kutuplu Dağıtım Ünitesi (7x12 mm) / 125A 4 Pole Distribution Unit (7x12 mm)



| Kod / Code | Ürün Tanımı / Product Name | L | B | H | Koli Adedi Box Qty. | Birim Fiyat Unit Price (Adet/pcs) |
|-------------|----------------------------|-----|----|----|------------------------|--------------------------------------|
| IRTU-740205 | 2+5 DELİKLİ / 2+5 HOLE | 65 | 90 | 74 | 10 | 885,00 TL |
| IRTU-740208 | 2+8 DELİKLİ / 2+8 HOLE | 87 | 90 | 74 | 8 | 961,90 TL |
| IRTU-740210 | 2+10 DELİKLİ / 2+10 HOLE | 102 | 90 | 74 | 6 | 1.064,50 TL |
| IRTU-740213 | 2+13 DELİKLİ / 2+13 HOLE | 126 | 90 | 74 | 5 | 1.320,50 TL |
| IRTU-740218 | 2+18 DELİKLİ / 2+18 HOLE | 162 | 90 | 74 | 4 | 1.718,60 TL |
| IRTU-740220 | 2+20 DELİKLİ / 2+20 HOLE | 175 | 90 | 74 | 4 | 1.834,00 TL |
| IRTU-740223 | 2+23 DELİKLİ / 2+23 HOLE | 197 | 90 | 74 | 4 | 2.115,70 TL |

125A 3 Kutuplu Dağıtım Ünitesi (7x12 mm) / 125A 3 Poles Distribution Unit (7x12 mm)



| Kod / Code | Ürün Tanımı / Product Name | L | B | H | Koli Adedi Box Qty. | Birim Fiyat Unit Price (Adet/pcs) |
|-------------|----------------------------|-----|-----|----|------------------------|--------------------------------------|
| IRTU-103205 | 2+5 DELİKLİ / 2+5 HOLE | 88 | 130 | 55 | 12 | 843,20 TL |
| IRTU-103208 | 2+8 DELİKLİ / 2+8 HOLE | 110 | 130 | 55 | 8 | 907,20 TL |
| IRTU-103210 | 2+10 DELİKLİ / 2+10 HOLE | 124 | 130 | 55 | 8 | 982,40 TL |
| IRTU-103213 | 2+13 DELİKLİ / 2+13 HOLE | 150 | 130 | 55 | 6 | 1.200,00 TL |
| IRTU-103218 | 2+18 DELİKLİ / 2+18 HOLE | 185 | 130 | 55 | 4 | 1.512,00 TL |
| IRTU-103220 | 2+20 DELİKLİ / 2+20 HOLE | 200 | 130 | 55 | 4 | 1.641,60 TL |

125A 4 Kutuplu Dağıtım Ünitesi (7x12 mm) / 125A 4 Poles Distribution Unit (7x12 mm)



| Kod / Code | Ürün Tanımı / Product Name | L | B | H | Koli Adedi Box Qty. | Birim Fiyat Unit Price (Adet/pcs) |
|-------------|----------------------------|-----|-----|----|------------------------|--------------------------------------|
| IRTU-104205 | 2+5 DELİKLİ / 2+5 HOLE | 88 | 144 | 55 | 12 | 1.140,00 TL |
| IRTU-104208 | 2+8 DELİKLİ / 2+8 HOLE | 110 | 144 | 55 | 8 | 1.307,20 TL |
| IRTU-104210 | 2+10 DELİKLİ / 2+10 HOLE | 124 | 144 | 55 | 8 | 1.512,40 TL |
| IRTU-104213 | 2+13 DELİKLİ / 2+13 HOLE | 150 | 144 | 55 | 6 | 1.808,80 TL |
| IRTU-104218 | 2+18 DELİKLİ / 2+18 HOLE | 185 | 144 | 55 | 4 | 2.318,00 TL |
| IRTU-104220 | 2+20 DELİKLİ / 2+20 HOLE | 200 | 144 | 55 | 4 | 2.422,50 TL |

125A 5 Kutuplu Dağıtım Ünitesi (7x12 mm) / 125A 5 Poles Distribution Unit (7x12 mm)

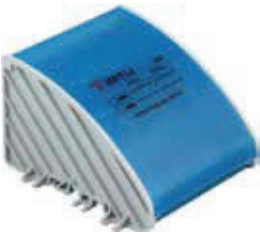

| Kod / Code | Ürün Tanımı / Product Name | L | B | H | Koli Adedi Box Qty. | Birim Fiyat Unit Price (Adet/pcs) |
|-------------|----------------------------|-----|-----|----|------------------------|--------------------------------------|
| IRTU-105205 | 2+5 DELİKLİ / 2+5 HOLE | 88 | 151 | 95 | 8 | 1.307,20 TL |
| IRTU-105208 | 2+8 DELİKLİ / 2+8 HOLE | 110 | 151 | 95 | 4 | 1.512,40 TL |
| IRTU-105210 | 2+10 DELİKLİ / 2+10 HOLE | 124 | 151 | 95 | 4 | 1.808,50 TL |
| IRTU-105213 | 2+13 DELİKLİ / 2+13 HOLE | 150 | 151 | 95 | 4 | 1.909,50 TL |
| IRTU-105218 | 2+18 DELİKLİ / 2+18 HOLE | 185 | 151 | 95 | 4 | 2.500,40 TL |
| IRTU-105220 | 2+20 DELİKLİ / 2+20 HOLE | 200 | 151 | 95 | 4 | 3.002,00 TL |

160A Tek Kutuplu Dağıtım Ünitesi (10x15 mm) / 160A One Pole Distribution Unit (10x15 mm)



| Kod / Code | Ürün Tanımı / Product Name | L | B | H | Koli Adedi / Box Qty. | Birim Fiyat / Unit Price (Adet/pcs) |
|-------------|--|-----|----|----|-----------------------|-------------------------------------|
| IRTU-150205 | 2+5 7 DELİKLİ ÜNİTE / 2+5 7 HOLE UNITS | 110 | 40 | 40 | 25 | 804,70 TL |
| IRTU-150208 | 2+8 10 DELİKLİ ÜNİTE / 2+8 10 HOLE UNITS | 120 | 40 | 40 | 25 | 985,40 TL |
| IRTU-150210 | 2+10 12 DELİKLİ ÜNİTE / 2+10 12 HOLE UNITS | 155 | 40 | 40 | 15 | 1.125,80 TL |
| IRTU-150213 | 2+13 15 DELİKLİ ÜNİTE / 2+13 15 HOLE UNITS | 180 | 40 | 40 | 15 | 1.341,60 TL |
| IRTU-150218 | 2+18 20 DELİKLİ ÜNİTE / 2+18 20 HOLE UNITS | 220 | 40 | 40 | 10 | 1.747,20 TL |
| IRTU-150220 | 2+20 22 DELİKLİ ÜNİTE / 2+20 22 HOLE UNITS | 240 | 40 | 40 | 10 | 1.872,00 TL |

160A 3 Kutuplu Dağıtım Ünitesi (10x15 mm) / 160A 3 Poles Distribution Unit (10x15 mm)



| Kod / Code | Ürün Tanımı / Product Name | L | B | H | Koli Adedi / Box Qty. | Birim Fiyat / Unit Price (Adet/pcs) |
|-------------|----------------------------|-----|-----|----|-----------------------|-------------------------------------|
| IRTU-151205 | 2+5 DELİKLİ / 2+5 HOLE | 105 | 130 | 55 | 12 | 1.425,00 TL |
| IRTU-151208 | 2+8 DELİKLİ / 2+8 HOLE | 145 | 130 | 55 | 8 | 2.115,70 TL |
| IRTU-151210 | 2+10 DELİKLİ / 2+10 HOLE | 165 | 130 | 55 | 8 | 2.538,40 TL |
| IRTU-151213 | 2+13 DELİKLİ / 2+13 HOLE | 200 | 130 | 55 | 6 | 3.102,70 TL |
| IRTU-151218 | 2+18 DELİKLİ / 2+18 HOLE | 255 | 130 | 55 | 4 | 4.231,30 TL |
| IRTU-151220 | 2+20 DELİKLİ / 2+20 HOLE | 275 | 130 | 55 | 4 | 4.674,00 TL |

160A 4 Kutuplu Dağıtım Ünitesi (10x15 mm) / 160A 4 Poles Distribution Unit (10x15 mm)



| Kod / Code | Ürün Tanımı / Product Name | L | B | H | Koli Adedi / Box Qty. | Birim Fiyat / Unit Price (Adet/pcs) |
|-------------|----------------------------|-----|-----|----|-----------------------|-------------------------------------|
| IRTU-152205 | 2+5 DELİKLİ / 2+5 HOLE | 105 | 144 | 55 | 12 | 1.615,00 TL |
| IRTU-152208 | 2+8 DELİKLİ / 2+8 HOLE | 145 | 144 | 55 | 8 | 2.384,50 TL |
| IRTU-152210 | 2+10 DELİKLİ / 2+10 HOLE | 165 | 144 | 55 | 8 | 2.692,30 TL |
| IRTU-152213 | 2+13 DELİKLİ / 2+13 HOLE | 200 | 144 | 55 | 6 | 3.499,80 TL |
| IRTU-152218 | 2+18 DELİKLİ / 2+18 HOLE | 255 | 144 | 55 | 4 | 4.550,50 TL |
| IRTU-152220 | 2+20 DELİKLİ / 2+20 HOLE | 275 | 144 | 55 | 4 | 4.706,30 TL |

160A 5 Kutuplu Dağıtım Ünitesi (10x15 mm) / 160A 5 Poles Distribution Unit (10x15 mm)



| Kod / Code | Ürün Tanımı / Product Name | L | B | H | Koli Adedi / Box Qty. | Birim Fiyat / Unit Price (Adet/pcs) |
|-------------|----------------------------|-----|-----|----|-----------------------|-------------------------------------|
| IRTU-153205 | 2+5 DELİKLİ / 2+5 HOLE | 105 | 151 | 95 | 8 | 1.976,00 TL |
| IRTU-153208 | 2+8 DELİKLİ / 2+8 HOLE | 145 | 151 | 95 | 4 | 2.688,50 TL |
| IRTU-153210 | 2+10 DELİKLİ / 2+10 HOLE | 165 | 151 | 95 | 4 | 3.230,00 TL |
| IRTU-153213 | 2+13 DELİKLİ / 2+13 HOLE | 200 | 151 | 95 | 4 | 4.039,40 TL |
| IRTU-153218 | 2+18 DELİKLİ / 2+18 HOLE | 255 | 151 | 95 | 4 | 5.386,50 TL |
| IRTU-153220 | 2+20 DELİKLİ / 2+20 HOLE | 275 | 151 | 95 | 4 | 5.928,00 TL |

250A 4 Kutuplu Dağıtım Ünitesi (4x20 mm Bakır)
250A 4 Poles Distribution Unit (4x20 mm Copper)

| Kod / Code | Ürün Tanımı / Product Name | L | B | H | Koli Adedi Box Qty. | Birim Fiyat Unit Price (Adet/pcs) |
|-------------|--|-----|-----|----|------------------------|--------------------------------------|
| IRTU-425007 | 1 GİRİŞ - 7 ÇIKIŞ / 1 INPUT - 7 OUTPUT | 220 | 150 | 95 | 6 | 3.524,50 TL |
| IRTU-425010 | 1 GİRİŞ - 10 ÇIKIŞ / 1 INPUT - 10 OUTPUT | 280 | 150 | 39 | 4 | 3.733,50 TL |
| IRTU-425014 | 1 GİRİŞ - 14 ÇIKIŞ / 1 INPUT - 14 OUTPUT | 314 | 150 | 39 | 4 | 4.560,00 TL |

Formlama İzolatör Ayak (3/4 Kutuplu - Max 40x10 mm Bara İle Kullanılır)
Forming Insulator Foot (3/4 Pole - Max 40x10 mm Used With Busbar)

| Kod / Code | Ürün Tanımı / Product Name | Koli Adedi Box Qty. | Birim Fiyat (Takım) Unit Price (Set / 2 pcs) |
|------------|---|------------------------|---|
| İRTPF-4003 | 3 Kutuplu Formlama İzolatörü (Max. 40x10) | 1 | 640,00 TL |
| İRTPF-4004 | 4 Kutuplu Formlama İzolatörü (Max. 40x10) | 1 | 765,00 TL |

* Sağ + Sol Ünite kombinasyonu ile minimum 1 set olarak sevk edilir.

* Shipped as minimum 1 set with Right + Left Unit combination

UL 94 V0 Yanmazlık seviyesi, ergonomik ve kompakt yapı, yüksek kısa devre güçlerine karşı geliştirilmiş tasarımıyla kısadevre dinamikleri ve kamçılamalara karşı maksimum emniyetle güvenli ve estetik bara dizaynı sağlayacak form 1-2-3-4 seçenekleriyle kolay montaj ve işletme çözümü sunar.



With its UL 94 V0 non-flammability level, ergonomic and compact structure, designed against high short-circuit forces, it provides a safe and aesthetic busbar designed with maximum safety against cross-circuit dynamics and gnawing. It offers easy assembly and operation solution in Form1-2-3-4 options.

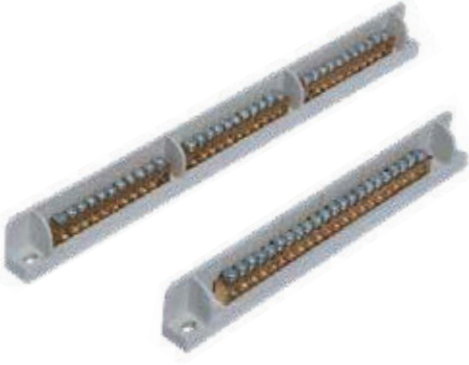

Tüm ürünler;
All products;

- Vidalar Cr+3 kaplamalıdır.
Screws are coated with cr+3.
- M5 58 pirinç malzemeden üretilmektedir.
Produced by M5 58 brass material.
- Plastik parçalar yanmaz (VO)'dür.
Plastic parts are non-flammable (VO).
- Plastik izolasyon parçaları birbirine geçme olup değişik ölçülerde yapılabilir.
The plastic parts are intertwined and can be made in different sizes.

Tek Kutuplu İzolasyonlu Topraklama Klemensi 80A (6,5x9 mm)
One Pole Insulated Panel Grounding Terminal 80A (6,5x9 mm)

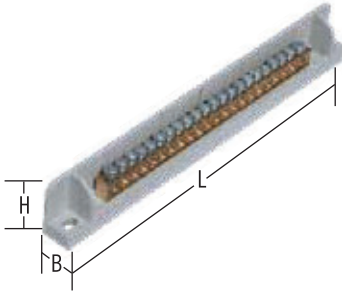

| Kod / Code | Ürün Tanımı / Product Name | L | B | H | Koli Adedi / Box Qty. | Birim Fiyat / Unit Price (Adet/pcs) |
|---------------|---|-----|-----|-------|-----------------------|-------------------------------------|
| IRTU-TKG10010 | 1x10 DELİK TEK KUTUP / 1x10 HOLE ONE POLE | 128 | 115 | 25.65 | 100 | 268,80 TL |
| IRTU-TKG10011 | 1x11 DELİK TEK KUTUP / 1x11 HOLE ONE POLE | 128 | 115 | 25.65 | 100 | 288,00 TL |
| IRTU-TKG10015 | 1x15 DELİK TEK KUTUP / 1x15 HOLE ONE POLE | 128 | 115 | 25.65 | 100 | 368,00 TL |
| IRTU-TKG10020 | 1x20 DELİK TEK KUTUP / 1x20 HOLE ONE POLE | 183 | 168 | 25.65 | 100 | 440,00 TL |
| IRTU-TKG10030 | 1x30 DELİK TEK KUTUP / 1x30 HOLE ONE POLE | 225 | 213 | 25.65 | 100 | 496,00 TL |

İki Kutuplu İzolasyonlu Topraklama Klemensi 80A (6,5x9 mm)
Two Pole Insulated Panel Grounding Terminal 80A (6,5x9 mm)

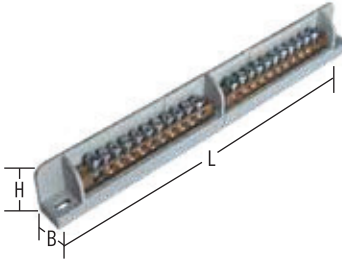

| Kod / Code | Ürün Tanımı / Product Name | L | B | H | Koli Adedi / Box Qty. | Birim Fiyat / Unit Price (Adet/pcs) |
|---------------|---|-----|-----|-------|-----------------------|-------------------------------------|
| IRTU-TKG20008 | 2x8 DELİK İKİ KUTUP / 2x8 HOLE TWO POLE | 182 | 168 | 25.65 | 100 | 334,40 TL |
| IRTU-TKG20011 | 2x11 DELİK İKİ KUTUP / 2x11 HOLE TWO POLE | 182 | 168 | 25.65 | 100 | 368,00 TL |
| IRTU-TKG20015 | 2x15 DELİK İKİ KUTUP / 2x15 HOLE TWO POLE | 260 | 245 | 25.65 | 100 | 409,60 TL |

Üç Kutuplu İzolasyonlu Topraklama Klemensi 80A - 125A
Three Pole Insulated Panel Grounding Terminal 80A - 125A

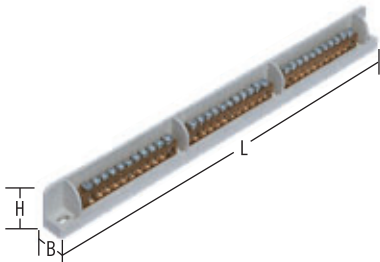

| Kod / Code | Ürün Tanımı / Product Name | L | B | H | Koli Adedi / Box Qty. | Birim Fiyat / Unit Price (Adet/pcs) |
|---------------|--|-----|-----|-------|-----------------------|-------------------------------------|
| IRTU-TKG30011 | 3x11 DELİK ÜÇ KUTUP (6,5x9 mm) / 3x11 HOLE THREE POLE (6,5x9 mm) | 260 | 245 | 25.65 | 100 | 377,60 TL |
| IRTU-TKG31011 | 3x11 DELİK ÜÇ KUTUP (7x12 mm) / 3x11 HOLE THREE POLE (7x12 mm) | 260 | 245 | 25.65 | 100 | 595,00 TL |

Kapalı İzole Klemensler 63A (6x8 mm)

Terminals with Plastic Cover 63A (6x8 mm)

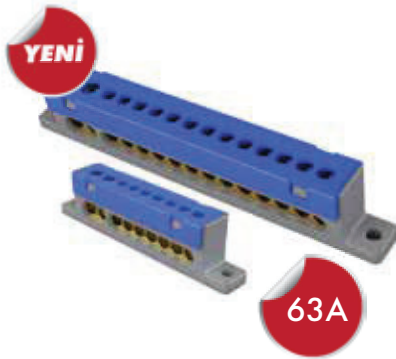

| Kod / Code | Ürün Tanımı / Product Name | L | B | H | Koli Ad. Box Qty. | Birim Fiyat / Unit Price (Adet/pcs) |
|--------------|--|-----|----|----|----------------------|--|
| IRTU-IKV6304 | 4 DELİKLİ İZOLE KLEMENS / 4 INSULATED TERMINAL | 71 | 11 | 20 | 200 | 58,60 TL |
| IRTU-IKV6305 | 5 DELİKLİ İZOLE KLEMENS / 5 INSULATED TERMINAL | 71 | 11 | 20 | 200 | 63,50 TL |
| IRTU-IKV6306 | 6 DELİKLİ İZOLE KLEMENS / 6 INSULATED TERMINAL | 71 | 11 | 20 | 200 | 72,00 TL |
| IRTU-IKV6307 | 7 DELİKLİ İZOLE KLEMENS / 7 INSULATED TERMINAL | 71 | 11 | 20 | 200 | 77,20 TL |
| IRTU-IKV6309 | 9 DELİKLİ İZOLE KLEMENS / 9 INSULATED TERMINAL | 116 | 11 | 20 | 150 | 85,70 TL |
| IRTU-IKV6310 | 10 DELİKLİ İZOLE KLEMENS / 10 INSULATED TERMINAL | 116 | 11 | 20 | 150 | 100,50 TL |
| IRTU-IKV6312 | 12 DELİKLİ İZOLE KLEMENS / 12 INSULATED TERMINAL | 116 | 11 | 20 | 150 | 117,80 TL |
| IRTU-IKV6315 | 15 DELİKLİ İZOLE KLEMENS / 15 INSULATED TERMINAL | 116 | 11 | 20 | 150 | 152,00 TL |

Kapalı İzole Klemensler 80A (6,5x9 mm)

Terminals with Plastic Cover 80A (6,5x9 mm)

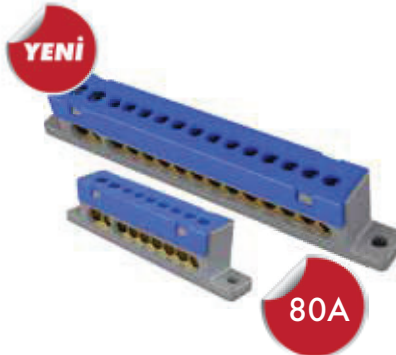

| Kod / Code | Ürün Tanımı / Product Name | L | B | H | Koli Ad. Box Qty. | Birim Fiyat / Unit Price (Adet/pcs) |
|-------------|--|-----|----|----|----------------------|--|
| IRTU-IK8004 | 4 DELİKLİ İZOLE KLEMENS / 4 INSULATED TERMINAL | 71 | 11 | 20 | 200 | 64,60 TL |
| IRTU-IK8005 | 5 DELİKLİ İZOLE KLEMENS / 5 INSULATED TERMINAL | 71 | 11 | 20 | 200 | 71,30 TL |
| IRTU-IK8006 | 6 DELİKLİ İZOLE KLEMENS / 6 INSULATED TERMINAL | 71 | 11 | 20 | 200 | 79,80 TL |
| IRTU-IK8007 | 7 DELİKLİ İZOLE KLEMENS / 7 INSULATED TERMINAL | 71 | 11 | 20 | 200 | 85,50 TL |
| IRTU-IK8009 | 9 DELİKLİ İZOLE KLEMENS / 9 INSULATED TERMINAL | 116 | 11 | 20 | 150 | 95,00 TL |
| IRTU-IK8010 | 10 DELİKLİ İZOLE KLEMENS / 10 INSULATED TERMINAL | 116 | 11 | 20 | 150 | 111,20 TL |
| IRTU-IK8012 | 12 DELİKLİ İZOLE KLEMENS / 12 INSULATED TERMINAL | 116 | 11 | 20 | 150 | 130,20 TL |
| IRTU-IK8015 | 15 DELİKLİ İZOLE KLEMENS / 15 INSULATED TERMINAL | 116 | 11 | 20 | 150 | 167,20 TL |

Kapalı İzole Klemensler 63A (6x8 mm)

Terminals with Plastic Cover 63A (6x8 mm)

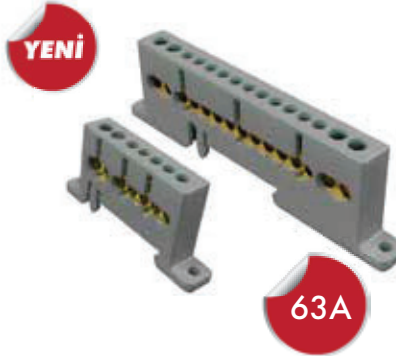

| Kod / Code | Ürün Tanımı / Product Name | L | B | H | Koli Ad. Box Qty. | Birim Fiyat / Unit Price (Adet/pcs) |
|--------------|--|-----|----|----|----------------------|--|
| IRTU-IKR6304 | 4 DELİKLİ İZOLE KLEMENS / 4 INSULATED TERMINAL | 71 | 11 | 20 | 200 | 71,60 TL |
| IRTU-IKR6305 | 5 DELİKLİ İZOLE KLEMENS / 5 INSULATED TERMINAL | 71 | 11 | 20 | 200 | 79,00 TL |
| IRTU-IKR6306 | 6 DELİKLİ İZOLE KLEMENS / 6 INSULATED TERMINAL | 71 | 11 | 20 | 200 | 84,00 TL |
| IRTU-IKR6307 | 7 DELİKLİ İZOLE KLEMENS / 7 INSULATED TERMINAL | 71 | 11 | 20 | 200 | 93,90 TL |
| IRTU-IKR6309 | 9 DELİKLİ İZOLE KLEMENS / 9 INSULATED TERMINAL | 116 | 11 | 20 | 150 | 100,70 TL |
| IRTU-IKR6310 | 10 DELİKLİ İZOLE KLEMENS / 10 INSULATED TERMINAL | 116 | 11 | 20 | 150 | 111,20 TL |
| IRTU-IKR6312 | 12 DELİKLİ İZOLE KLEMENS / 12 INSULATED TERMINAL | 116 | 11 | 20 | 150 | 133,00 TL |
| IRTU-IKR6315 | 15 DELİKLİ İZOLE KLEMENS / 15 INSULATED TERMINAL | 116 | 11 | 20 | 150 | 167,20 TL |

Kapalı İzole Klemensler 80A (6,5x9 mm)

Terminals with Plastic Cover 80A (6,5x9 mm)

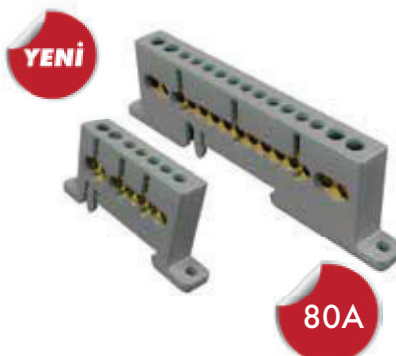

| Kod / Code | Ürün Tanımı / Product Name | L | B | H | Koli Ad. Box Qty. | Birim Fiyat / Unit Price (Adet/pcs) |
|--------------|--|-----|----|----|----------------------|--|
| IRTU-IKR8004 | 4 DELİKLİ İZOLE KLEMENS / 4 INSULATED TERMINAL | 71 | 11 | 20 | 200 | 80,80 TL |
| IRTU-IKR8005 | 5 DELİKLİ İZOLE KLEMENS / 5 INSULATED TERMINAL | 71 | 11 | 20 | 200 | 85,50 TL |
| IRTU-IKR8006 | 6 DELİKLİ İZOLE KLEMENS / 6 INSULATED TERMINAL | 71 | 11 | 20 | 200 | 95,00 TL |
| IRTU-IKR8007 | 7 DELİKLİ İZOLE KLEMENS / 7 INSULATED TERMINAL | 71 | 11 | 20 | 200 | 104,50 TL |
| IRTU-IKR8009 | 9 DELİKLİ İZOLE KLEMENS / 9 INSULATED TERMINAL | 116 | 11 | 20 | 150 | 123,50 TL |
| IRTU-IKR8010 | 10 DELİKLİ İZOLE KLEMENS / 10 INSULATED TERMINAL | 116 | 11 | 20 | 150 | 133,00 TL |
| IRTU-IKR8012 | 12 DELİKLİ İZOLE KLEMENS / 12 INSULATED TERMINAL | 116 | 11 | 20 | 150 | 146,30 TL |
| IRTU-IKR8015 | 15 DELİKLİ İZOLE KLEMENS / 15 INSULATED TERMINAL | 116 | 11 | 20 | 150 | 184,30 TL |

Ayaklı Pano Topraklama Klemensleri 63A (6x8 mm)
Panel Grounding Terminals with Plastic Foot 63A (6x8 mm)

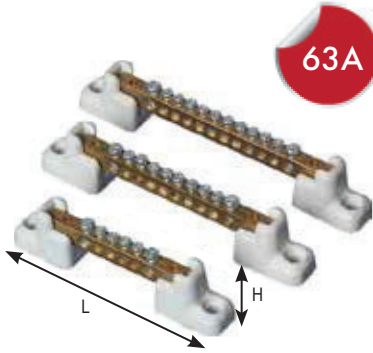

| Kod / Code | Ürün Tanımı / Product Name | L | H | Koli Ad. / Box Qty. | Birim Fiyat / Unit Price (Adet/pcs) |
|--------------|---|-----|----|---------------------|-------------------------------------|
| IRTU-TKA8006 | 6 DELİKLİ A.TOP. KLM. / 6 PERFORATED TERMINAL WITH FOOT | 85 | 21 | 100 | 87,40 TL |
| IRTU-TKA8007 | 7 DELİKLİ A.TOP. KLM. / 7 PERFORATED TERMINAL WITH FOOT | 90 | 21 | 90 | 97,50 TL |
| IRTU-TKA8010 | 10 DELİKLİ A.TOP. KLM. / 10 PERFORATED TERMINAL WITH FOOT | 108 | 21 | 80 | 115,40 TL |
| IRTU-TKA8012 | 12 DELİKLİ A.TOP. KLM. / 12 PERFORATED TERMINAL WITH FOOT | 120 | 21 | 70 | 124,50 TL |
| IRTU-TKA8015 | 15 DELİKLİ A.TOP. KLM. / 15 PERFORATED TERMINAL WITH FOOT | 138 | 21 | 70 | 149,20 TL |
| IRTU-TKA8020 | 20 DELİKLİ A.TOP. KLM. / 20 PERFORATED TERMINAL WITH FOOT | 165 | 21 | 50 | 197,60 TL |
| IRTU-TKA8022 | 22 DELİKLİ A.TOP. KLM. / 22 PERFORATED TERMINAL WITH FOOT | 177 | 21 | 50 | 207,60 TL |
| IRTU-TKA8025 | 25 DELİKLİ A.TOP. KLM. / 25 PERFORATED TERMINAL WITH FOOT | 190 | 21 | 50 | 225,20 TL |
| IRTU-TKA8030 | 30 DELİKLİ A.TOP. KLM. / 30 PERFORATED TERMINAL WITH FOOT | 220 | 21 | 50 | 273,60 TL |

Ayaklı Pano Topraklama Klemensleri 80A (6,5x9 mm)
Panel Grounding Terminals with Plastic Foot 80A (6,5x9 mm)

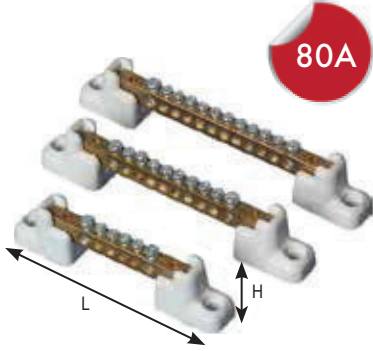

| Kod / Code | Ürün Tanımı / Product Name | L | H | Koli Ad. / Box Qty. | Birim Fiyat / Unit Price (Adet/pcs) |
|--------------|---|-----|----|---------------------|-------------------------------------|
| IRTU-TKA9006 | 6 DELİKLİ A.TOP. KLM. / 6 PERFORATED TERMINAL WITH FOOT | 87 | 22 | 100 | 85,00 TL |
| IRTU-TKA9007 | 7 DELİKLİ A.TOP. KLM. / 7 PERFORATED TERMINAL WITH FOOT | 94 | 22 | 90 | 93,00 TL |
| IRTU-TKA9010 | 10 DELİKLİ A.TOP. KLM. / 10 PERFORATED TERMINAL WITH FOOT | 106 | 22 | 80 | 111,00 TL |
| IRTU-TKA9012 | 12 DELİKLİ A.TOP. KLM. / 12 PERFORATED TERMINAL WITH FOOT | 124 | 22 | 70 | 119,80 TL |
| IRTU-TKA9015 | 15 DELİKLİ A.TOP. KLM. / 15 PERFORATED TERMINAL WITH FOOT | 141 | 22 | 70 | 142,20 TL |
| IRTU-TKA9020 | 20 DELİKLİ A.TOP. KLM. / 20 PERFORATED TERMINAL WITH FOOT | 168 | 22 | 50 | 187,00 TL |
| IRTU-TKA9022 | 22 DELİKLİ A.TOP. KLM. / 22 PERFORATED TERMINAL WITH FOOT | 181 | 22 | 50 | 229,40 TL |
| IRTU-TKA9025 | 25 DELİKLİ A.TOP. KLM. / 25 PERFORATED TERMINAL WITH FOOT | 196 | 22 | 50 | 251,00 TL |
| IRTU-TKA9030 | 30 DELİKLİ A.TOP. KLM. / 30 PERFORATED TERMINAL WITH FOOT | 231 | 22 | 50 | 348,60 TL |

Ayaklı Pano Topraklama Klemensleri 125A (7x12 mm)
Panel Grounding Terminals with Plastic Foot 125A (7x12 mm)

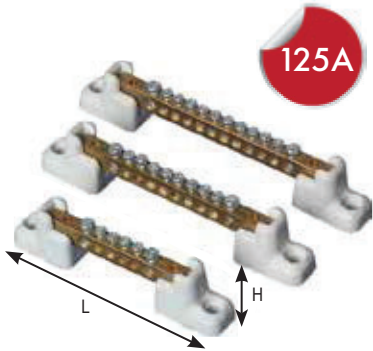

| Kod / Code | Ürün Tanımı / Product Name | L | H | Koli Ad. / Box Qty. | Birim Fiyat / Unit Price (Adet/pcs) |
|--------------|---|-----|----|---------------------|-------------------------------------|
| IRTU-TKA1206 | 6 DELİKLİ A.TOP. KLM. / 6 PERFORATED TERMINAL WITH FOOT | 91 | 22 | 150 | 124,40 TL |
| IRTU-TKA1207 | 7 DELİKLİ A.TOP. KLM. / 7 PERFORATED TERMINAL WITH FOOT | 98 | 22 | 150 | 126,80 TL |
| IRTU-TKA1210 | 10 DELİKLİ A.TOP. KLM. / 10 PERFORATED TERMINAL WITH FOOT | 120 | 22 | 100 | 150,40 TL |
| IRTU-TKA1212 | 12 DELİKLİ A.TOP. KLM. / 12 PERFORATED TERMINAL WITH FOOT | 137 | 22 | 100 | 174,00 TL |
| IRTU-TKA1215 | 15 DELİKLİ A.TOP. KLM. / 15 PERFORATED TERMINAL WITH FOOT | 156 | 22 | 100 | 226,00 TL |
| IRTU-TKA1220 | 20 DELİKLİ A.TOP. KLM. / 20 PERFORATED TERMINAL WITH FOOT | 186 | 22 | 100 | 269,00 TL |
| IRTU-TKA1225 | 25 DELİKLİ A.TOP. KLM. / 25 PERFORATED TERMINAL WITH FOOT | 226 | 22 | 80 | 355,00 TL |
| IRTU-TKA1230 | 30 DELİKLİ A.TOP. KLM. / 30 PERFORATED TERMINAL WITH FOOT | 266 | 22 | 75 | 485,00 TL |

Ayaklı Pano Topraklama Klemensleri 160A (10x15 mm)
Panel Grounding Terminals with Plastic Foot 160A (10x15 mm)

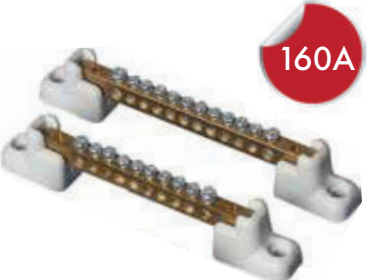

| Kod / Code | Ürün Tanımı / Product Name | L | H | Koli Ad. / Box Qty. | Birim Fiyat / Unit Price (Adet/pcs) |
|--------------|---|-----|----|---------------------|-------------------------------------|
| IRTU-TKA1507 | 7 DELİKLİ TOP. KLEMENSİ / 7 PERFORATED TERMINAL | 110 | 30 | 100 | 538,70 TL |
| IRTU-TKA1510 | 10 DELİKLİ TOP. KLEMENSİ / 10 PERFORATED TERMINAL | 145 | 30 | 100 | 602,30 TL |
| IRTU-TKA1512 | 12 DELİKLİ TOP. KLEMENSİ / 12 PERFORATED TERMINAL | 172 | 30 | 75 | 718,20 TL |
| IRTU-TKA1515 | 15 DELİKLİ TOP. KLEMENSİ / 15 PERFORATED TERMINAL | 199 | 30 | 50 | 974,70 TL |
| IRTU-TKA1520 | 20 DELİKLİ TOP. KLEMENSİ / 20 PERFORATED TERMINAL | 225 | 30 | 50 | 1.235,00 TL |

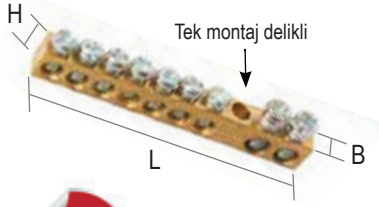
Tek Montaj Pano Topraklama Klemensleri 63A (6x8 mm)
Single Installations Panel Grounding Terminals 63A (6x8 mm)

63A

| Kod / Code | Ürün Tanımı / Product Name | L | B | H | Koli Ad. / Box Qty. | Birim Fiyat / Unit Price (Adet/pcs) |
|-------------|---|----|---|---|---------------------|-------------------------------------|
| IRTU-TK6804 | 4 DELİKLİ TOP. KLEMENSİ / 4 PERFORATED TERMINAL | 33 | 6 | 8 | 1500 | 41,00 TL |
| IRTU-TK6805 | 5 DELİKLİ TOP. KLEMENSİ / 5 PERFORATED TERMINAL | 38 | 6 | 8 | 1250 | 46,20 TL |
| IRTU-TK6806 | 6 DELİKLİ TOP. KLEMENSİ / 6 PERFORATED TERMINAL | 45 | 6 | 8 | 1000 | 55,10 TL |
| IRTU-TK6807 | 7 DELİKLİ TOP. KLEMENSİ / 7 PERFORATED TERMINAL | 50 | 6 | 8 | 1000 | 60,30 TL |
| IRTU-TK6809 | 9 DELİKLİ TOP. KLEMENSİ / 9 PERFORATED TERMINAL | 62 | 6 | 8 | 750 | 69,30 TL |
| IRTU-TK6810 | 10 DELİKLİ TOP. KLEMENSİ / 10 PERFORATED TERMINAL | 68 | 6 | 8 | 750 | 84,60 TL |
| IRTU-TK6812 | 12 DELİKLİ TOP. KLEMENSİ / 12 PERFORATED TERMINAL | 80 | 6 | 8 | 500 | 102,60 TL |

Ayaksız Pano Topraklama Klemensleri 63A (6x8 mm)
Panel Grounding Terminals without Plastic Foot 63A (6x8 mm)

63A

| Kod / Code | Ürün Tanımı / Product Name | L | B | H | Koli Ad. / Box Qty. | Birim Fiyat / Unit Price (Adet/pcs) |
|-------------|---|-----|---|---|---------------------|-------------------------------------|
| IRTU-TK8006 | 6 DELİKLİ TOP. KLEMENSİ / 6 PERFORATED TERMINAL | 52 | 6 | 8 | 500 | 82,00 TL |
| IRTU-TK8007 | 7 DELİKLİ TOP. KLEMENSİ / 7 PERFORATED TERMINAL | 57 | 6 | 8 | 500 | 92,30 TL |
| IRTU-TK8010 | 10 DELİKLİ TOP. KLEMENSİ / 10 PERFORATED TERMINAL | 76 | 6 | 8 | 400 | 110,30 TL |
| IRTU-TK8012 | 12 DELİKLİ TOP. KLEMENSİ / 12 PERFORATED TERMINAL | 88 | 6 | 8 | 400 | 120,70 TL |
| IRTU-TK8015 | 15 DELİKLİ TOP. KLEMENSİ / 15 PERFORATED TERMINAL | 105 | 6 | 8 | 250 | 143,50 TL |
| IRTU-TK8020 | 20 DELİKLİ TOP. KLEMENSİ / 20 PERFORATED TERMINAL | 134 | 6 | 8 | 250 | 192,80 TL |
| IRTU-TK8022 | 22 DELİKLİ TOP. KLEMENSİ / 22 PERFORATED TERMINAL | 146 | 6 | 8 | 250 | 203,30 TL |

Tek Montaj Pano Topraklama Klemensleri 80A (6,5x9 mm)
Single Installations Panel Grounding Terminals 80A (6,5x9 mm)

80A

| Kod / Code | Ürün Tanımı / Product Name | L | B | H | Koli Ad. / Box Qty. | Birim Fiyat / Unit Price (Adet/pcs) |
|-------------|---|----|---|-----|---------------------|-------------------------------------|
| IRTU-TK9004 | 4 DELİKLİ TOP. KLEMENSİ / 4 PERFORATED TERMINAL | 33 | 9 | 6,5 | 1500 | 50,60 TL |
| IRTU-TK9005 | 5 DELİKLİ TOP. KLEMENSİ / 5 PERFORATED TERMINAL | 38 | 9 | 6,5 | 1250 | 56,90 TL |
| IRTU-TK9006 | 6 DELİKLİ TOP. KLEMENSİ / 6 PERFORATED TERMINAL | 45 | 9 | 6,5 | 1000 | 67,90 TL |
| IRTU-TK9007 | 7 DELİKLİ TOP. KLEMENSİ / 7 PERFORATED TERMINAL | 50 | 9 | 6,5 | 1000 | 74,40 TL |
| IRTU-TK9009 | 9 DELİKLİ TOP. KLEMENSİ / 9 PERFORATED TERMINAL | 62 | 9 | 6,5 | 750 | 85,30 TL |
| IRTU-TK9010 | 10 DELİKLİ TOP. KLEMENSİ / 10 PERFORATED TERMINAL | 68 | 9 | 6,5 | 750 | 104,00 TL |
| IRTU-TK9012 | 12 DELİKLİ TOP. KLEMENSİ / 12 PERFORATED TERMINAL | 80 | 9 | 6,5 | 500 | 126,40 TL |

Ayaksız Pano Topraklama Klemensleri 80A (6,5x9 mm)
Panel Grounding Terminals without Plastic Foot 80A (6,5x9 mm)



80A

| Kod / Code | Ürün Tanımı / Product Name | L | B | H | Koli Ad. / Box Qty. | Birim Fiyat / Unit Price (Adet/pcs) |
|-------------|---|-----|---|-----|---------------------|-------------------------------------|
| IRTU-TK0006 | 6 DELİKLİ TOP. KLEMENSİ / 6 PERFORATED TERMINAL | 62 | 9 | 6,5 | 500 | 80,00 TL |
| IRTU-TK0007 | 7 DELİKLİ TOP. KLEMENSİ / 7 PERFORATED TERMINAL | 69 | 9 | 6,5 | 500 | 88,60 TL |
| IRTU-TK0010 | 10 DELİKLİ TOP. KLEMENSİ / 10 PERFORATED TERMINAL | 83 | 9 | 6,5 | 400 | 104,00 TL |
| IRTU-TK0012 | 12 DELİKLİ TOP. KLEMENSİ / 12 PERFORATED TERMINAL | 99 | 9 | 6,5 | 400 | 112,80 TL |
| IRTU-TK0015 | 15 DELİKLİ TOP. KLEMENSİ / 15 PERFORATED TERMINAL | 116 | 9 | 6,5 | 250 | 136,00 TL |
| IRTU-TK0020 | 20 DELİKLİ TOP. KLEMENSİ / 20 PERFORATED TERMINAL | 143 | 9 | 6,5 | 250 | 179,20 TL |
| IRTU-TK0022 | 22 DELİKLİ TOP. KLEMENSİ / 22 PERFORATED TERMINAL | 156 | 9 | 6,5 | 250 | 224,00 TL |
| IRTU-TK0025 | 25 DELİKLİ TOP. KLEMENSİ / 25 PERFORATED TERMINAL | 173 | 9 | 6,5 | 100 | 244,00 TL |
| IRTU-TK0030 | 30 DELİKLİ TOP. KLEMENSİ / 30 PERFORATED TERMINAL | 206 | 9 | 6,5 | 100 | 341,60 TL |

Ayaksız Pano Topraklama Klemensleri 125A (7x12 mm)
Panel Grounding Terminals without Plastic Foot 125A (7x12 mm)



125A

| Kod / Code | Ürün Tanımı / Product Name | L1 | L2 | B | H | Koli Ad. / Box Qty. | Birim Fiyat / Unit Price (Adet/pcs) |
|-------------|---|-----|-----|---|----|---------------------|-------------------------------------|
| IRTU-TK1206 | 6 DELİKLİ TOP. KLEMENSİ / 6 PERFORATED TERMINAL | 69 | 55 | 7 | 12 | 150 | 114,40 TL |
| IRTU-TK1207 | 7 DELİKLİ TOP. KLEMENSİ / 7 PERFORATED TERMINAL | 76 | 62 | 7 | 12 | 150 | 116,80 TL |
| IRTU-TK1210 | 10 DELİKLİ TOP. KLEMENSİ / 10 PERFORATED TERMINAL | 98 | 84 | 7 | 12 | 100 | 140,40 TL |
| IRTU-TK1212 | 12 DELİKLİ TOP. KLEMENSİ / 12 PERFORATED TERMINAL | 115 | 101 | 7 | 12 | 100 | 164,00 TL |
| IRTU-TK1215 | 15 DELİKLİ TOP. KLEMENSİ / 15 PERFORATED TERMINAL | 134 | 120 | 7 | 12 | 100 | 216,00 TL |
| IRTU-TK1220 | 20 DELİKLİ TOP. KLEMENSİ / 20 PERFORATED TERMINAL | 164 | 150 | 7 | 12 | 100 | 260,80 TL |
| IRTU-TK1225 | 25 DELİKLİ TOP. KLEMENSİ / 25 PERFORATED TERMINAL | 204 | 190 | 7 | 12 | 80 | 345,60 TL |
| IRTU-TK1230 | 30 DELİKLİ TOP. KLEMENSİ / 30 PERFORATED TERMINAL | 244 | 230 | 7 | 12 | 75 | 475,20 TL |

Ayaksız Pano Topraklama Klemensleri 160A (10x15 mm)
Panel Grounding Terminals without Plastic Foot 160A (10x15 mm)

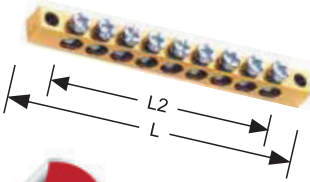

160A

| Kod / Code | Ürün Tanımı / Product Name | L1 | L2 | Koli Ad. / Box Qty. | Birim Fiyat / Unit Price (Adet/pcs) |
|-------------|---|-----|-----|---------------------|-------------------------------------|
| IRTU-TK1507 | 7 DELİKLİ TOP. KLEMENSİ / 7 PERFORATED TERMINAL | 100 | 90 | 100 | 510,30 TL |
| IRTU-TK1510 | 10 DELİKLİ TOP. KLEMENSİ / 10 PERFORATED TERMINAL | 135 | 124 | 100 | 570,60 TL |
| IRTU-TK1512 | 12 DELİKLİ TOP. KLEMENSİ / 12 PERFORATED TERMINAL | 157 | 147 | 75 | 680,40 TL |
| IRTU-TK1515 | 15 DELİKLİ TOP. KLEMENSİ / 15 PERFORATED TERMINAL | 190 | 180 | 50 | 923,40 TL |
| IRTU-TK1520 | 20 DELİKLİ TOP. KLEMENSİ / 20 PERFORATED TERMINAL | 265 | 255 | 50 | 1.170,00 TL |

Topraklama Barası / Copper Ground Busbar

| Kod / Code | Vida Sayısı / Count of Screw | Bakır Kalınlığı / Copper Thickness | Uzunluk / Length (mt) | Paket Miktarı / Box Qty | Birim Fiyat / Unit Price (Adet/pcs) |
|-------------|------------------------------|------------------------------------|-----------------------|-------------------------|-------------------------------------|
| IRTU-TB3115 | 31 | 1,5 x 15,0 | 1 | 25 | 1.450,00 TL |
| IRTU-TB6115 | 61 | 1,5 x 15,0 | 1 | 25 | 1.850,00 TL |
| IRTU-TB3120 | 31 | 2,0 x 15,0 | 1 | 25 | 1.750,00 TL |
| IRTU-TB6120 | 61 | 2,0 x 15,0 | 1 | 25 | 2.150,00 TL |
| IRTU-TB3130 | 31 | 3,0 x 15,0 | 1 | 25 | 2.450,00 TL |
| IRTU-TB6130 | 61 | 3,0 x 15,0 | 1 | 25 | 2.850,00 TL |

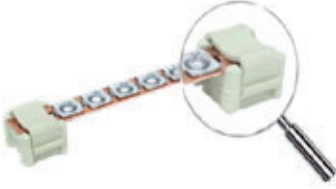
Vidalı Bara Mesnedi / Terminal Blocks Support Bracket

| Kod / Code | Cinsi / Type | Paket Miktarı / Box Qty | Birim Fiyat / Unit Price (Adet/pcs) |
|--------------|---|-------------------------|-------------------------------------|
| IRTU-KBM1001 | Kumanda Bara Mesnedi / Screwed Busbar Support | 500 | 18,80 TL |

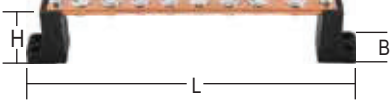
Plastik Ayaklı Bakır Topraklama Barası (4x20 mm)
Copper Panel Grounding Terminal With Plastic Foot (4x20mm)

| Kod / Code | Ürün Tanımı / Product Name | L | B | H | Koli Ad. / Box Qty. | Birim Fiyat / Unit Price (Adet/pcs) |
|-------------|--------------------------------------|-----|----|----|---------------------|-------------------------------------|
| IRTU-205220 | 1 Giriş 7 Çıkış / 1 Input 7 Output | 220 | 40 | 39 | 100 | 1.077,00 TL |
| IRTU-205270 | 1 Giriş 10 Çıkış / 1 Input 10 Output | 270 | 40 | 39 | 75 | 1.345,00 TL |
| IRTU-205345 | 1 Giriş 14 Çıkış / 1 Input 14 Output | 345 | 40 | 39 | 50 | 1.720,00 TL |

Eş Potansiyel Bara / Copper Ground Bar Kit



| Kod / Code | Ürün Tanımı / Product Name | Kutu Adedi / Box Qty. | Birim Fiyat / Unit Price (Adet/pcs) |
|-------------|--|-----------------------|-------------------------------------|
| IRTU-303250 | 30 x 3 25 cm 7 Delik / 30 x 3 25 cm 7 Hole | 1 | |
| IRTU-303300 | 30 x 3 30 cm 10 Delik / 30 x 3 30 cm 10 Hole | 1 | |
| IRTU-305300 | 30 x 5 30 cm 7 Delik / 30 x 5 30 cm 7 Hole | 1 | |
| IRTU-305400 | 30 x 5 40 cm 9 Delik / 30 x 5 40 cm 9 Hole | 1 | |
| IRTU-305500 | 30 x 5 50 cm 12 DELİK / 30 x 5 50 cm 12 Hole | 1 | |

Bakır Bağlantı Klemensi / Copper Connection Terminal

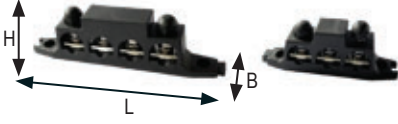

| Kod / Code | Ürün Tanımı / Product Name | L | B | H | Koli Ad. Box Qty. | Birim Fiyat / Unit Price (Adet/pcs) |
|--------------|--|-----|----|----|-------------------|-------------------------------------|
| IRTU-GDB4010 | 4x1-Tekli Güç Dağıtım Barası (125A) / Power Distribution Busbar (125A) | 120 | 20 | 19 | 50 | |
| IRTU-GDB2010 | 2x1-İki Kutuplu Güç Dağıtım Barası (125A) / Power Distribution Busbar (125A) | 120 | 20 | 19 | 50 | |
| IRTU-GDB3010 | 3x1 Tekli Güç Dağıtım Barası (400A) / Power Distribution Busbar (400A) | 200 | 39 | 34 | 50 | |

Bakır Bağlantı Klemensi / Copper Connection Terminal



| Kod / Code | Ürün Tanımı / Product Name | L | B | H | Koli Ad. Box Qty. | Birim Fiyat / Unit Price (Adet/pcs) |
|--------------|---|-----|------|----|-------------------|-------------------------------------|
| IRTU-GDB4011 | 4x1 Tekli Dağıtım Barası (300A) (Kapaklı) | 195 | 28,5 | 52 | 50 | |
| IRTU-GDB3011 | 3x1 Tekli Dağıtım Barası (300A) (Kapaklı) | 146 | 28,5 | 52 | 50 | |

Bakır Bağlantı Klemensi / Copper Connection Terminal

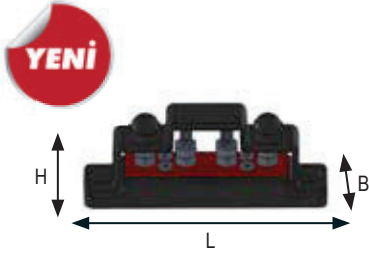

| Kod / Code | Ürün Tanımı / Product Name | L | B | H | Koli Ad. Box Qty. | Birim Fiyat / Unit Price (Adet/pcs) |
|--------------|--|-------|----|----|-------------------|-------------------------------------|
| IRTU-GDB4012 | 4x1-Tekli Güç Dağıtım Barası M6 (220A) / Connection Busbar M6 (220A) | 116 | 23 | 48 | 50 | |
| IRTU-GDB3012 | 3x1-Tekli Bağlantı Klemensi M8 (300A) / Connection Busbar M8 (300A) | 103,5 | 28 | 49 | 50 | |

Bakır Bağlantı Klemensi / Copper Connection Terminal

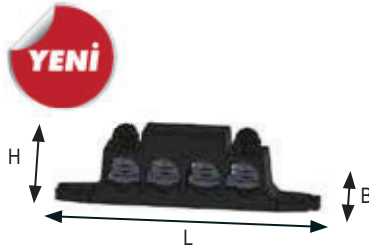

| Kod / Code | Ürün Tanımı / Product Name | L | B | H | Koli Ad. Box Qty. | Birim Fiyat / Unit Price (Adet/pcs) |
|--------------|--|--------|----|----|-------------------|-------------------------------------|
| IRTU-GDB2011 | 2x1 Çift Kutuplu Dağıtım Barası (300A) (Kapaklı) | 194,40 | 28 | 49 | 50 | |

Bakır Bağlantı Klemensi / Copper Connection Terminal

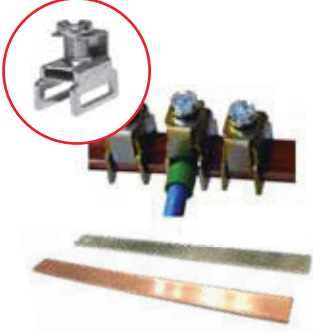

| Kod / Code | Ürün Tanımı / Product Name | L | B | H | Koli Ad. Box Qty. | Birim Fiyat / Unit Price (Adet/pcs) |
|--------------|--|-----|----|----|-------------------|-------------------------------------|
| IRTU-GDB2012 | 2x1 Çift Kutuplu Dağıtım Barası (300A) (Kapaklı) | 116 | 23 | 44 | 50 | |

Geçmeli Bakır Bara Bağlantı Klemensi (Paletli Sistem)
Interfaced Busbar Connection Terminal (Track System)

| Kod / Code | Ürün Tanımı / Product Name | Kutu Adedi / Box Qty | Birim Fiyat / Unit Price (Adet/pcs) |
|------------|---|----------------------|-------------------------------------|
| IRTU-2159 | SK12 F3 Bakır Bara Klemensi 4 mm ² / Copper Terminal | 500 | 20,95 TL |
| IRTU-2160 | SK12 F3 Bakır Bara Klemensi 16 mm ² / Copper Terminal | 300 | 22,25 TL |
| IRTU-2161 | SK12 F3 Bakır Bara Klemensi 35 mm ² / Copper Terminal | 250 | 26,00 TL |
| IRTU-2162 | 12 x 3 mm Elektrolitik Bakır Bara 1 mt / Electrolytic Copper Busbar | 1 Mt | |

Bakır Bara Bağlantı Klemensi (Yay Baskılı)
Busbar Connection Terminal (Spring System)

| Kod / Code | Kesit / Cros Section | Ürün Tanımı / Product Name | Kutu Adedi / Box Qty | Birim Fiyat / Unit Price (Adet/pcs) |
|------------|----------------------|--|----------------------|-------------------------------------|
| IRTU-2140 | 16 mm ² | SK16F5 Bakır Bara Klemensi 1,5-16 mm ² / Copper Terminal | 100 | 58,50 TL |
| IRTU-2142 | 35 mm ² | SK35F5 Bakır Bara Klemensi 1,5-35 mm ² / Copper Terminal | 100 | 104,25 TL |
| IRTU-2144 | 70 mm ² | SK70F5 Bakır Bara Klemensi 16-70 mm ² / Copper Terminal | 25 | 172,00 TL |
| IRTU-2146 | 120 mm ² | SK120F5 Bakır Bara Klemensi 16-120 mm ² / Copper Terminal | 25 | 287,50 TL |

U Klemensler
U Type Terminal Blocks

U Klemens plastik kapağı dahildir.

| Kod / Code | Ürün Tanımı / Product Name | Kutu Adedi / Box Qty. | Birim Fiyat / Unit Price (Adet/pcs) |
|------------|----------------------------|-----------------------|-------------------------------------|
| IRTU-7050 | 6'lık U Klemens | 300 | 135,00 TL |
| IRTU-7051 | 10'luk U Klemens | 250 | 165,00 TL |
| IRTU-7052 | 16'lık U Klemens | 150 | 210,00 TL |
| IRTU-7053 | 25'lik U Klemens | 100 | 245,00 TL |
| IRTU-7054 | 35'lik U Klemens | 75 | 285,00 TL |
| IRTU-7055 | 50'lik U Klemens | 50 | 445,00 TL |
| IRTU-7056 | 70'lik U Klemens | 40 | 455,00 TL |
| IRTU-7057 | 95'lik U Klemens | 30 | 655,00 TL |
| IRTU-7058 | 120'lik U Klemens | 20 | 715,00 TL |
| IRTU-7059 | 150'lik U Klemens | 10 | 1.050,00 TL |
| IRTU-7060 | U Klemens Kayığı | 100 | |

Tırnaklı Klemensler
Clawed Clamps



| Kod / Code | Ürün Tanımı / Product Name | Kutu Adedi / Box Qty. | Birim Fiyat / Unit Price (Adet/pcs) |
|------------|-----------------------------|-----------------------|-------------------------------------|
| IRTU-7070 | No. 1 16 mm ² | 500 | |
| IRTU-7071 | No. 2 25 mm ² | 250 | |
| IRTU-7072 | No. 3 35 mm ² | 100 | |
| IRTU-7073 | No. 4 50 mm ² | 100 | |
| IRTU-7074 | No. 5 70 mm ² | 100 | |
| IRTU-7075 | No. 6-7 120 mm ² | 50 | |

- Örgü : 0,20 mm Cu-ETP teller, som veya kalaylı
- Kontak Alanı : Kaynaksız - dikişsiz Cu-ETP boru; som-kalaylı, kaynaksız presli
- İzolasyon : Özel vinil karışım
Maksimum çalışma sıcaklığı: 105 °C
Kendi kendine sönebilen: UL 94 VO
Yalıtıkanlık direnci: 20kv/mm
Maksimum çalışma voltajı: 1000V AC - 1500V DC

Flexi Örgü Baralar - Flexible Braid Busbar

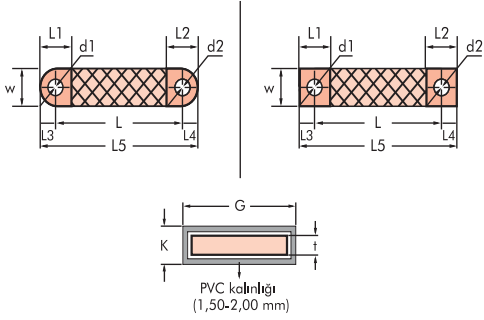

Örnek Ölçülendirme Tablosu



| Kesit mm ² Diameter mm ² | L mm | L1 mm | L2 mm | L3 mm | L4 mm | L5 mm | W mm | T mm | K mm | G mm | D1 mm | D2 mm |
|---|---------|----------|----------|----------|----------|----------|---------|---------|---------|---------|----------|----------|
| 25 mm ² | 230 | 25 | 25 | 11 | 7 | 248 | 20 | 3,2 | 7 | 24 | 10,5 | 8,5 |
| | 630 | 25 | 25 | 11 | 7 | 648 | 20 | 3,2 | 7 | 24 | 10,5 | 8,5 |
| 50 mm ² | 230 | 25 | 25 | 11 | 7 | 248 | 20 | 5 | 9 | 24 | 10,5 | 8,5 |
| | 630 | 25 | 25 | 11 | 7 | 648 | 20 | 5 | 9 | 24 | 10,5 | 8,5 |
| 95 mm ² | 230 | 25 | 25 | 11 | 11 | 258 | 25 | 7,5 | 12 | 29 | 10,5 | 10,5 |
| | 630 | 25 | 25 | 11 | 11 | 658 | 25 | 7,5 | 12 | 29 | 10,5 | 10,5 |
| 150 mm ² | 330 | 30 | 30 | 11 | 11 | 355 | 30 | 10 | 15 | 34 | 12,5 | 12,5 |
| | 830 | 30 | 30 | 11 | 11 | 855 | 30 | 10 | 15 | 34 | 12,5 | 12,5 |

SKP Pabuçlu Kalay Kaplı Yuvarlak Kapı Topraklama Barası
Flexible Collection Busbar



| Kod / Code | Ürün Tanımı / Product Name | Kutu Adedi / Box Qty. | Birim Fiyat / Unit Price (Adet/pcs) |
|-------------|---|--------------------------|--|
| IRTU-066150 | 6 mm ² M6 Boy (L):150 / 6 mm ² M6 (L):150 | 100 | ₺ |
| IRTU-066200 | 6 mm ² M6 Boy (L):200 / 6 mm ² M6 (L):200 | 100 | ₺ |
| IRTU-106200 | 10 mm ² M6 Boy (L):200 / 10 mm ² M6 (L):200 | 100 | ₺ |
| IRTU-106250 | 10 mm ² M6 Boy (L):250 / 10 mm ² M6 (L):250 | 100 | ₺ |
| IRTU-166200 | 16 mm ² M6 Boy (L):200 / 16 mm ² M6 (L):200 | 100 | ₺ |
| IRTU-166250 | 16 mm ² M6 Boy (L):250 / 16 mm ² M6 (L):250 | 100 | ₺ |

İzoleli Esnek Bakır Baralar
Insulated Flexible Copper Busbar



| A | Genişlik / Width | Kalınlık / Thickness | Adet / Sheet/Pcs | mm ² | T (K) AMPER | | | Birim Fiyat / Unit Pr. (adet/pcs) |
|-------|---------------------|-------------------------|---------------------|-----------------|-------------|-------|-------|---|
| | | | | | 40 °C | 50 °C | 60 °C | |
| 125A | 9 | 0,8 | 3 | 21,6 | 120 | 134 | 147 | ₺ |
| | 13 | 0,5 | 3 | 19,5 | 150 | 167 | 184 | ₺ |
| 250A | 15,5 | 8 | 4 | 49,6 | 286 | 320 | 350 | ₺ |
| | 20 | 1 | 3 | 60 | 323 | 360 | 395 | ₺ |
| 630A | 24 | 1 | 8 | 192 | 606 | 678 | 743 | ₺ |
| | 32 | 1 | 5 | 160 | 573 | 640 | 702 | ₺ |
| 1000A | 63 | 1 | 5 | 315 | 920 | 1030 | 1125 | ₺ |
| | 80 | 1 | 5 | 400 | 1050 | 1175 | 1285 | ₺ |
| 1250A | 63 | 1 | 8 | 504 | 1245 | 1395 | 1532 | ₺ |
| | 80 | 1 | 6 | 480 | 1230 | 1375 | 1505 | ₺ |

W OTOMAT BARALARI

Monofaze Müşterek Bara / 1Phase Insulated Busbar Pin Type

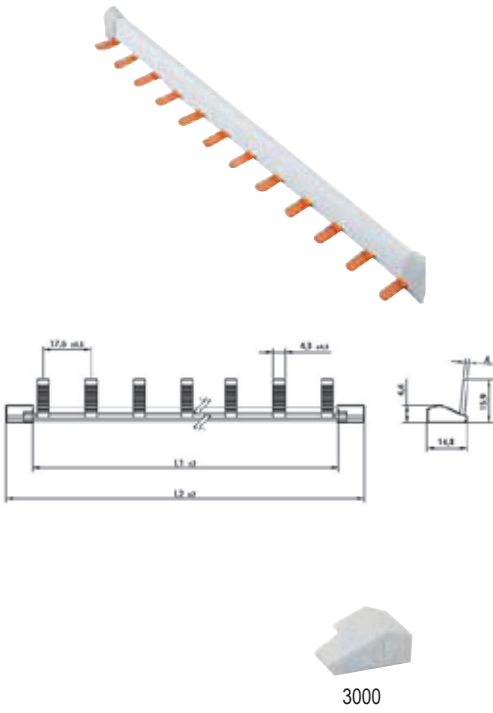

| Kod / Code | Faz / Phase | Modül Sayısı Module Number | Bakır Kalınlığı Copper Thickness | Kutu Adedi Box Qty | Birim Fiyat Unit Pr. (adet/pcs) |
|------------|-------------------------|-------------------------------|-------------------------------------|-----------------------|------------------------------------|
| IRTU-3006 | 1 FAZ | 12 | 1,0 mm / 80A | 50 | 230,00 TL |
| IRTU-3007 | 1 FAZ | 18 | 1,0 mm / 80A | 50 | 347,00 TL |
| IRTU-3008 | 1 FAZ | 24 | 1,0 mm / 80A | 50 | 495,00 TL |
| IRTU-3009 | 1 FAZ | 30 | 1,0 mm / 80A | 50 | 575,00 TL |
| IRTU-3010 | 1 FAZ | 56 | 1,0 mm / 80A | 50 | 1.040,00 TL |
| IRTU-3001 | 1 FAZ | 12 | 1,5 mm / 100A | 50 | 325,00 TL |
| IRTU-3002 | 1 FAZ | 18 | 1,5 mm / 100A | 50 | 485,00 TL |
| IRTU-3003 | 1 FAZ | 24 | 1,5 mm / 100A | 50 | 665,00 TL |
| IRTU-3004 | 1 FAZ | 30 | 1,5 mm / 100A | 50 | 815,00 TL |
| IRTU-3005 | 1 FAZ | 56 | 1,5 mm / 100A | 50 | 1.485,00 TL |
| IRTU-3011 | 1 FAZ | 12 | 2,0 mm / 125A | 50 | 410,00 TL |
| IRTU-3012 | 1 FAZ | 18 | 2,0 mm / 125A | 50 | 620,00 TL |
| IRTU-3013 | 1 FAZ | 24 | 2,0 mm / 125A | 50 | 830,00 TL |
| IRTU-3014 | 1 FAZ | 30 | 2,0 mm / 125A | 50 | 1.050,00 TL |
| IRTU-3015 | 1 FAZ | 56 | 2,0 mm / 125A | 50 | 1.880,00 TL |
| IRTU-3000 | MONOFAZE BARA YAN KAPAK | | | 100 | 9,50 TL |

İki Fazlı Müşterek Bara / Two Phases Insulated Busbar Pin Type

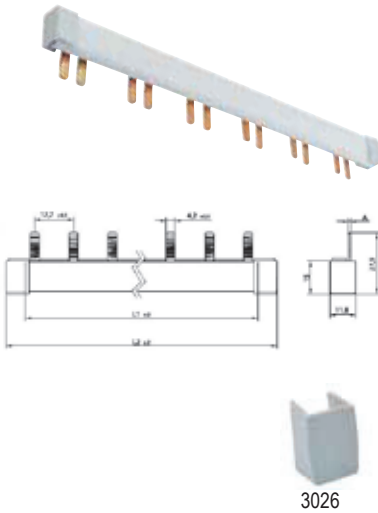

| Kod / Code | Faz / Phase | Modül Sayısı Module Number | Bakır Kalınlığı Copper Thickness | Kutu Adedi Box Qty | Birim Fiyat Unit Pr. (adet/pcs) |
|------------|-----------------------------------|-------------------------------|-------------------------------------|-----------------------|------------------------------------|
| IRTU-3021 | 2 FAZ | 6 | 1 mm / 80A | 30 | 460,00 TL |
| IRTU-3022 | 2 FAZ | 9 | 1 mm / 80A | 30 | 775,00 TL |
| IRTU-3023 | 2 FAZ | 12 | 1 mm / 80A | 30 | 885,00 TL |
| IRTU-3024 | 2 FAZ | 15 | 1 mm / 80A | 30 | 1.150,00 TL |
| IRTU-3025 | 2 FAZ | 28 | 1 mm / 80A | 30 | 2.050,00 TL |
| IRTU-3031 | 2 FAZ | 6 | 1,5 mm / 100A | 30 | 655,00 TL |
| IRTU-3032 | 2 FAZ | 9 | 1,5 mm / 100A | 30 | 860,00 TL |
| IRTU-3033 | 2 FAZ | 12 | 1,5 mm / 100A | 30 | 1.250,00 TL |
| IRTU-3034 | 2 FAZ | 15 | 1,5 mm / 100A | 30 | 1.560,00 TL |
| IRTU-3035 | 2 FAZ | 28 | 1,5 mm / 100A | 30 | 2.850,00 TL |
| IRTU-3026 | İKİ FAZLI MÜŞTEREK BARA YAN KAPAK | | | 100 | 31,20 TL |

Trifaze Müşterek Bara / Three Phases Insulated Busbar Pin Type

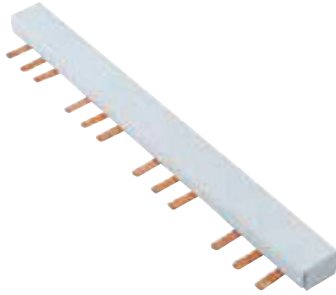

| Kod / Code | Faz / Phase | Modül Sayısı Module Number | Bakır Kalınlığı Copper Thickness | Kutu Adedi Box Qty | Birim Fiyat Unit Pr. (adet/pcs) |
|------------|---------------------------------|-------------------------------|-------------------------------------|-----------------------|------------------------------------|
| IRTU-3041 | 3 FAZ | 4 | 1,0 mm / 80A | 30 | 685,00 TL |
| IRTU-3042 | 3 FAZ | 6 | 1,0 mm / 80A | 30 | 1.050,00 TL |
| IRTU-3043 | 3 FAZ | 8 | 1,0 mm / 80A | 30 | 1.450,00 TL |
| IRTU-3044 | 3 FAZ | 10 | 1,0 mm / 80A | 30 | 1.700,00 TL |
| IRTU-3045 | 3 FAZ | 20 | 1,0 mm / 80A | 25 | 3.480,00 TL |
| IRTU-3051 | 3 FAZ | 4 | 1,5 mm / 100A | 30 | 950,00 TL |
| IRTU-3052 | 3 FAZ | 6 | 1,5 mm / 100A | 30 | 1.450,00 TL |
| IRTU-3053 | 3 FAZ | 8 | 1,5 mm / 100A | 30 | 1.980,00 TL |
| IRTU-3054 | 3 FAZ | 10 | 1,5 mm / 100A | 30 | 2.450,00 TL |
| IRTU-3055 | 3 FAZ | 20 | 1,5 mm / 100A | 25 | 4.680,00 TL |
| IRTU-3066 | 3 FAZ | 4 | 2,0 mm / 125A | 30 | 1.260,00 TL |
| IRTU-3067 | 3 FAZ | 6 | 2,0 mm / 125A | 30 | 1.960,00 TL |
| IRTU-3068 | 3 FAZ | 8 | 2,0 mm / 125A | 30 | 2.540,00 TL |
| IRTU-3069 | 3 FAZ | 10 | 2,0 mm / 125A | 30 | 3.180,00 TL |
| IRTU-3070 | 3 FAZ | 20 | 2,0 mm / 125A | 25 | 6.290,00 TL |
| IRTU-3056 | TRİFAZE BARA YAN KAPAK (1,5 mm) | | | 100 | 17,35 TL |
| IRTU-5833 | TRİFAZE BARA YAN KAPAK (1 mm) | | | 100 | 16,95 TL |

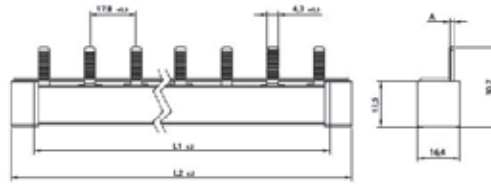

3 Faz + Nötr Müşterek W Otomat Bara / 3 Phase + Neutral Joint W Automat Bar

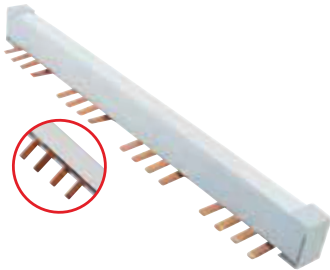

| Kod / Code | Faz / Phase | Modül Sayısı Module Number | Bakır Kalınlığı Copper Thickness | Kutu Adedi Box Qty | Birim Fiyat Unit Pr. (adet/pcs) |
|------------|----------------------------------|-------------------------------|-------------------------------------|-----------------------|------------------------------------|
| IRTU-3058 | 3 Faz + Nötr / 3 Phase + Neutral | 4 | 1,5 mm | 16 | 1.920,00 TL |
| IRTU-3059 | 3 Faz + Nötr / 3 Phase + Neutral | 8 | 1,5 mm | 16 | 3.800,00 TL |
| IRTU-3060 | 3 Faz + Nötr / 3 Phase + Neutral | 14 | 1,5 mm | 16 | 6.600,00 TL |
| IRTU-3057 | Yan Kapak / Side Cover | | | 100 | 16,95 TL |

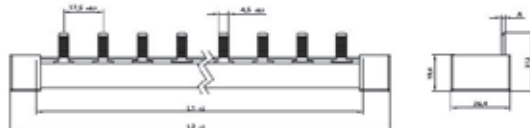

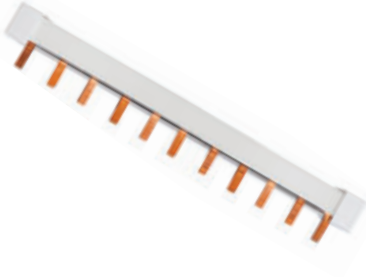
Müşterek W Otomat Bara (L1+N, L2+N, L3+N)
 Joint W Automat Bar (L1+N, L2+N, L3+N)

| Kod / Code | Faz / Phase | Modül Sayısı Module Number | Kutu Adedi Box Qty | Birim Fiyat Unit Pr. (adet/pcs) |
|----------------------|--------------------------|-------------------------------|-----------------------|------------------------------------|
| FTG-4ES16L54AOAON-01 | L1 + H, L2 + N, L3 + N.. | 13 Modül 1 M | 1 | 94,80 € |
| FTG-A2 | Yan Kapak / Side Cover | | 1 | 0,60 € |

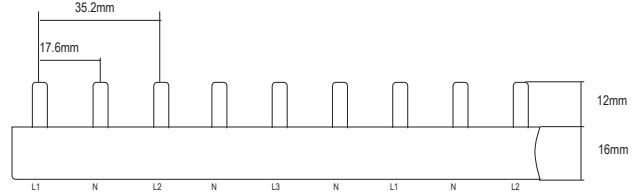
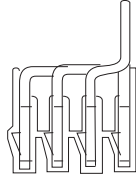
İzolasyonlu Motor Koruma Baraları / Insulated Engine Protection Bars

| Kod / Code | Faz / Phase | Adım Geniřliđi Step Width | Kutu Adedi Box Qty | Birim Fiyat Unit Pr. (adet/pcs) |
|------------------|---------------------------|------------------------------|-----------------------|------------------------------------|
| IRTU-MSVG54-14-2 | İkili Modül / Dual Module | 45 + 9 = 54 mm | 1 | 10,52 € |
| IRTU-MSVG54-14-4 | Dört Modül / Four Module | 45 + 9 = 54 mm | 1 | 15,58 € |
| IRTU-MSVG54-14-5 | Beř Modül / Five Module | 45 + 9 = 54 mm | 1 | 18,08 € |
| IRTU-MSVG45-14-3 | Üç Modül / Three Module | 45 mm | 1 | 12,80 € |
| IRTU-MSVG45-14-4 | Dört Modül / Four Module | 45 mm | 1 | 14,96 € |

W Otomat Bara Bağlantı Klemensi / Modular Power Terminal



| Kod / Code | Cinsi / Type | Kutu Adedi Box Qty | Birim Fiyat Unit Pr. (adet/pcs) |
|-----------------|---|-----------------------|------------------------------------|
| IRTU-3061 | No: 1 (2,5 - 10 mm ²) | 150 | 39,85 TL |
| IRTU-3065 | No: 2 (16 - 25 mm ²) | 100 | 65,95 TL |
| POLL-2010201 | No: 2 (6 - 25 mm ²) | 30 | |
| POLL-2010235 | No: 3 (6 - 50 mm ²) | 25 | |
| FTG-802/215 S | No: 2 (6 - 50 mm ²) | 25 | 2,90 € |
| FTG-MSV GE 1-14 | No.2 (6-25 mm ²) Çatal Uçlu, Üçlü (L1, L2, L3) / Fork Type Triple | 1 | |

AKSESUARLAR

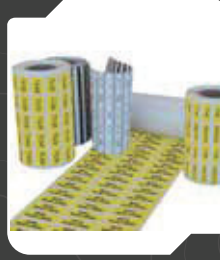

PANO İÇİ AYDINLATMA

- Standart Led Aydınlatma.
- Mıknatıslı Led Aydınlatma.
- Sensörlü Led Aydınlatma.
- 220V Led Aydınlatma.
- 12 - 24 Volt Aydınlatma.



MARKALA SİSTEMLERİ

- Komponent Etiketler.
- Kablolama Çözümleri.
- İnce ve Kalın Pano Etiketleri.
- Klemensler İçin Markalama Sistemleri.



SİNYAL VE BUTON GRUBU

- Ø22 Led Sinyaller.
- Işıklı ve Yaylı Butonlar.
- Acil Stop Mantar Butonlar.
- İkiz Butonlar.
- Mandal Butonlar.



PANO APARATLARI

- Pano Prizleri.
- Pano Perde Civatası.
- Plastik Cam Tutucu.
- Pano Köşe Aparatı.
- Sürgülü Kilitler.

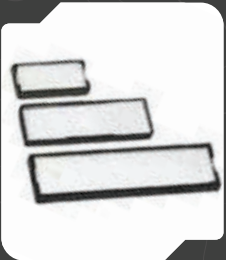

PANO ETİKETLERİ

- Otomat Altı Etiketleri.
- Pano Sinyal Etiketleri.
- Pano Uyarı Etiketleri
- Pvc ve Sac Uyarı Etiketleri.
- Pano İçi Kutu Etiketleri..



SAC AKSESUARLARI

- Makina Kapak Grupları.
- Pano Perde Civatası.
- Plastik Cam Tutucu.
- Pano Köşe Aparatı.
- Sürgülü Kilitler.



PLASTİK APARATLAR

- Proje Cepleri.
- Havalandırma Filtreleri.
- Pano Havalandırma Aparatı.
- Direnaj Tapası.



LED AYDINLATMALAR

22030/ES

22030/E

220 / 240 Volt Led Aydınlatma / 220 / 240 Voltage Led Panel lighting

| Kod / Code | Ürün Tanımı / Product Name | Volt / Voltage | L (mm) | H (mm) | Birim Fiyat (Standart) |
|-------------------|---|----------------|--------|--------|------------------------|
| IRTU-LED 22030-E | 30 cm Plastik Gövde Ekonomik / 30 cm Plastic Body Eco | 220 Volt | 300 | 23 | 9,60 \$ |
| IRTU-LED 22030-ES | 30 cm Alüminyum Gövde Ekonomik / 30 cm Aluminium Body Eco | 220 Volt | 300 | 23 | 11,00 \$ |

| Kod / Code | Ürün Tanımı / Product Name | Volt / Voltage | L (mm) | H (mm) | Birim Fiyat (Standart) |
|-----------------------|--|----------------|---------|---------------------|------------------------|
| IRTU-LED 22025 | 25 cm Led Pano Aydınlatması / 25 cm Led Panel Lighting | 220 Volt | 250 | 23 | 16,50 \$ |
| IRTU-LED 22030 | 30 cm Led Pano Aydınlatması / 30 cm Led Panel Lighting | 220 Volt | 300 | 23 | 17,20 \$ |
| IRTU-LED 22035 | 35 cm Led Pano Aydınlatması / 35 cm Led Panel Lighting | 220 Volt | 350 | 23 | 18,95 \$ |
| IRTU-LED 22045 | 45 cm Led Pano Aydınlatması / 45 cm Led Panel Lighting | 220 Volt | 450 | 23 | 20,80 \$ |
| IRTU-LED 22060 | 60 cm Led Pano Aydınlatması / 60 cm Led Panel Lighting | 220 Volt | 600 | 23 | 25,05 \$ |
| Voltaj : 110/220 V AC | | Güç : 5 W | IP : 20 | Frekans : 50/60 Hz. | Renk : Beyaz |

12 Volt Led Aydınlatma / 12 Voltage Led Panel Lighting

| Kod / Code | Ürün Tanımı / Product Name | Volt / Voltage | L (mm) | H (mm) | Birim Fiyat (Standart) |
|------------------|--|----------------|-----------|---------|------------------------|
| IRTU-LED 12025 | 25 cm Led Pano Aydınlatması / 25 cm Led Panel Lighting | 12 Volt | 250 | 23 | 15,05 \$ |
| IRTU-LED 12030 | 30 cm Led Pano Aydınlatması / 30 cm Led Panel Lighting | 12 Volt | 300 | 23 | 15,80 \$ |
| IRTU-LED 12045 | 45 cm Led Pano Aydınlatması / 45 cm Led Panel Lighting | 12 Volt | 450 | 23 | 20,05 \$ |
| IRTU-LED 12065 | 65 cm Led Pano Aydınlatması / 65 cm Led Panel Lighting | 12 Volt | 650 | 23 | 24,70 \$ |
| Voltaj : 12 V DC | | Renk : Beyaz | Güç : 4 W | IP : 20 | |

24 Volt Led Aydınlatma / 24 Voltage Led Panel Lighting

| Kod / Code | Ürün Tanımı / Product Name | Volt / Voltage | L (mm) | H (mm) | Birim Fiyat (Standart) |
|------------------|--|----------------|-----------|---------|------------------------|
| IRTU-LED 24025 | 25 cm Led Pano Aydınlatması / 25 cm Led Panel Lighting | 24 Volt | 250 | 23 | 15,05 \$ |
| IRTU-LED 24030 | 30 cm Led Pano Aydınlatması / 30 cm Led Panel Lighting | 24 Volt | 300 | 23 | 15,80 \$ |
| IRTU-LED 24045 | 45 cm Led Pano Aydınlatması / 45 cm Led Panel Lighting | 24 Volt | 450 | 23 | 20,05 \$ |
| IRTU-LED 24065 | 65 cm Led Pano Aydınlatması / 65 cm Led Panel Lighting | 24 Volt | 650 | 23 | 24,70 \$ |
| Voltaj : 24 V DC | | Renk : Beyaz | Güç : 4 W | IP : 20 | |

- Alüminyum Gövde
Aluminum body
- Plastik Geçme Ayaklarla Kolay Montaj
Easy Installation with Plastic Feet
- Değişken Ölçülerde ve Voltajlarda Üretim İmkanı
Production Opportunity in Variable Sizes and Voltages
- Aydınlatma Led Tipi ve Farklı Renk Seçenekleri (Beyaz, Günışığı, Kırmızı, Yeşil, Mavi)
Lighting Led Type and Different Color Options (White, Daylight, Red, Green, Blue)

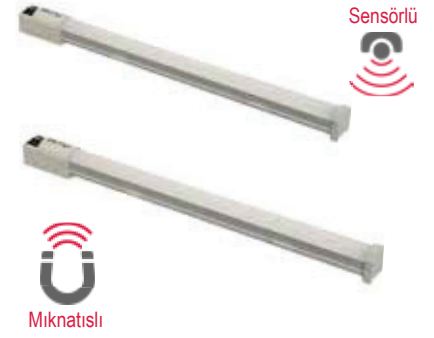

MIKNATISLI VE SENSÖRLÜ LED AYDINLATMA MAGNETIC AND SENSORED LED LIGHTING

220 / 240 Volt Led Aydınlatma / 220 / 240 Voltage Led Panel Lighting

| Kod / Code | Ürün Tanımı / Product Name | Volt / Voltage | L (mm) | H (mm) | Birim Fiyat (Mıknatıslı) | Kod / Code | Birim Fiyat (Sensörlü) |
|------------------|--|----------------|--------|--------|--------------------------|------------------|------------------------|
| IRTU-LED 22025/M | 25 cm Led Pano Aydınlatması / 25 cm Led Panel Lighting | 220 Volt | 250 | 23 | 26,00 \$ | IRTU-LED 22025/S | 31,50 \$ |
| IRTU-LED 22030/M | 30 cm Led Pano Aydınlatması / 30 cm Led Panel Lighting | 220 Volt | 300 | 23 | 26,60 \$ | IRTU-LED 22030/S | 32,55 \$ |
| IRTU-LED 22035/M | 35 cm Led Pano Aydınlatması / 35 cm Led Panel Lighting | 220 Volt | 350 | 23 | 29,45 \$ | IRTU-LED 22035/S | 35,50 \$ |
| IRTU-LED 22045/M | 45 cm Led Pano Aydınlatması / 45 cm Led Panel Lighting | 220 Volt | 450 | 23 | 30,00 \$ | IRTU-LED 22045/S | 36,55 \$ |
| IRTU-LED 22055/M | 55 cm Led Pano Aydınlatması / 55 cm Led Panel Lighting | 220 Volt | 550 | 23 | 33,25 \$ | IRTU-LED 22055/S | 43,30 \$ |
| IRTU-LED 22060/M | 60 cm Led Pano Aydınlatması / 60 cm Led Panel Lighting | 220 Volt | 600 | 23 | 41,50 \$ | IRTU-LED 22060/S | 49,90 \$ |

Voltaj : 110/220 V AC Güç : 5 W IP : 20 Frekans : 50/60 Hz. Renk : Beyaz

12 Volt Led Aydınlatma / 12 Voltage Led Panel Lighting

| Kod / Code | Ürün Tanımı / Product Name | Volt / Voltage | L (mm) | H (mm) | Birim Fiyat (Mıknatıslı) | Kod / Code | Birim Fiyat (Sensörlü) |
|------------------|--|----------------|--------|--------|--------------------------|------------------|------------------------|
| IRTU-LED 12025/M | 25 cm Led Pano Aydınlatması / 25 cm Led Panel Lighting | 12 Volt | 250 | 23 | 26,00 \$ | IRTU-LED 12025/S | 31,50 \$ |
| IRTU-LED 12030/M | 30 cm Led Pano Aydınlatması / 30 cm Led Panel Lighting | 12 Volt | 300 | 23 | 26,60 \$ | IRTU-LED 12030/S | 32,55 \$ |
| IRTU-LED 12035/M | 35 cm Led Pano Aydınlatması / 35 cm Led Panel Lighting | 12 Volt | 350 | 23 | 29,45 \$ | IRTU-LED 12035/S | 35,50 \$ |
| IRTU-LED 12045/M | 45 cm Led Pano Aydınlatması / 45 cm Led Panel Lighting | 12 Volt | 450 | 23 | 30,00 \$ | IRTU-LED 12045/S | 36,55 \$ |
| IRTU-LED 12055/M | 55 cm Led Pano Aydınlatması / 55 cm Led Panel Lighting | 12 Volt | 550 | 23 | 33,25 \$ | IRTU-LED 12055/S | 43,30 \$ |
| IRTU-LED 12065/M | 65 cm Led Pano Aydınlatması / 65 cm Led Panel Lighting | 12 Volt | 650 | 23 | 41,50 \$ | IRTU-LED 12065/S | 49,90 \$ |

Voltaj : 12 V DC Renk : Beyaz Güç : 4 W IP : 20

24 Volt Led Aydınlatma / 24 Voltage Led Panel Lighting

| Kod / Code | Ürün Tanımı / Product Name | Volt / Voltage | L (mm) | H (mm) | Birim Fiyat (Mıknatıslı) | Kod / Code | Birim Fiyat (Sensörlü) |
|------------------|--|----------------|--------|--------|--------------------------|------------------|------------------------|
| IRTU-LED 24025/M | 25 cm Led Pano Aydınlatması / 25 cm Led Panel Lighting | 24 Volt | 250 | 23 | 26,00 \$ | IRTU-LED 24025/S | 31,50 \$ |
| IRTU-LED 24030/M | 30 cm Led Pano Aydınlatması / 30 cm Led Panel Lighting | 24 Volt | 300 | 23 | 26,60 \$ | IRTU-LED 24030/S | 32,55 \$ |
| IRTU-LED 24035/M | 35 cm Led Pano Aydınlatması / 35 cm Led Panel Lighting | 24 Volt | 350 | 23 | 29,45 \$ | IRTU-LED 24035/S | 35,50 \$ |
| IRTU-LED 24045/M | 45 cm Led Pano Aydınlatması / 45 cm Led Panel Lighting | 24 Volt | 450 | 23 | 30,00 \$ | IRTU-LED 24045/S | 36,55 \$ |
| IRTU-LED 24055/M | 55 cm Led Pano Aydınlatması / 55 cm Led Panel Lighting | 24 Volt | 550 | 23 | 33,25 \$ | IRTU-LED 24055/S | 43,30 \$ |
| IRTU-LED 24065/M | 65 cm Led Pano Aydınlatması / 65 cm Led Panel Lighting | 24 Volt | 650 | 23 | 41,50 \$ | IRTU-LED 24065/S | 49,90 \$ |

Voltaj : 24 V DC Renk : Beyaz Güç : 4 W IP : 20

Ø22 Led Sinyal Lambası / Led Pilot Light

| Kod / Code | Ürün Tanımı / Product Name | Renk / Color | Birim Fiyat / Unit Price (adet / pcs) |
|------------|----------------------------|--------------|---------------------------------------|
| MB3-EV 916 | Led sinyal 220V AC/DC | | Beyaz / White 57,50 TL |
| MB3-EV 936 | | | Yeşil / Green 54,10 TL |
| MB3-EV 946 | | | Kırmızı / Red 54,10 TL |
| MB3-EV 956 | | | Sarı / Yellow 54,10 TL |
| MB3-EV 966 | | | Mavi / Blue 54,10 TL |
| MB3-EV 917 | Led sinyal 24V AC/DC | | Beyaz / White 57,50 TL |
| MB3-EV 937 | | | Yeşil / Green 54,10 TL |
| MB3-EV 947 | | | Kırmızı / Red 54,10 TL |
| MB3-EV 957 | | | Sarı / Yellow 54,10 TL |
| MB3-EV 967 | | | Mavi / Blue 54,10 TL |
| MB3-EV 918 | Led sinyal 110V AC/DC | | Beyaz / White 57,50 TL |
| MB3-EV 938 | | | Yeşil / Green 54,10 TL |
| MB3-EV 948 | | | Kırmızı / Red 54,10 TL |
| MB3-EV 958 | | | Sarı / Yellow 54,10 TL |
| MB3-EV 968 | | | Mavi / Blue 54,10 TL |



BA9S Neon Plastik



Led Plastik



BA9S Metal

Işıklı Yaylı Butonlar 220VAC 3A/250VAC
Illuminated Push Button

| Kod / Code | Renk / Color | Birim Fiyat / Unit Price (Adt/ Pcs) |
|-------------|--------------|-------------------------------------|
| IRTU-EW 611 | | Beyaz / White / NO |
| IRTU-EW 631 | | Yeşil / Green / NO |
| IRTU-EW 642 | | Kırmızı / Red / NC |
| IRTU-EW 651 | | Sarı / Yellow / NO |
| IRTU-EW 661 | | Mavi / Blue / NO |
| IRTU-EW 771 | | Beyaz / White / NO |
| IRTU-EW 731 | | Yeşil / Green / NO |
| IRTU-EW 742 | | Kırmızı / Red / NC |
| IRTU-EW 751 | | Sarı / Yellow / NO |
| IRTU-EW 761 | | Mavi / Blue / NO |
| IRTU-BW 611 | | Beyaz / White / NO |
| IRTU-BW 631 | | Yeşil / Green / NO |
| IRTU-BW 642 | | Kırmızı / Red / NC |
| IRTU-BW 651 | | Sarı / Yellow / NO |
| IRTU-BW 661 | | Mavi / Blue / NO |

Yaylı Butonlar, 3A / 250VAC
/ Spring Push Button

| | | |
|-------------|--|--------------------------------|
| IRTU-EA 210 | | Siyah / Black / NO |
| IRTU-EA 310 | | Yeşil / Green / NO |
| IRTU-EA 420 | | Kırmızı / Red / NC |
| IRTU-EA 510 | | Sarı / Yellow / NO |
| IRTU-EA 610 | | Mavi / Blue / NO |
| IRTU-BA 210 | | Siyah / Black / NO |
| IRTU-BA 310 | | Yeşil / Green / NO |
| IRTU-BA 420 | | Kırmızı / Red / NC |
| IRTU-BA 510 | | Sarı / Yellow / NO |
| IRTU-BA 610 | | Mavi / Blue / NO |
| IRTU-EA 112 | | Beyaz / White (→) / NO |
| IRTU-EA 212 | | Siyah / Black (←) / NO |
| IRTU-EA 514 | | Sarı Alarm / Yellow Alarm / NO |
| IRTU-EA 613 | | Mavi / Blue (↔) / NO |



Plastik / Plastic



Metal / Metal



İşaretli / Direction



Plastik / Plastic



Metal / Metal



Yaylı / Spring

Acil Stop Mantar Butonlar, 3A / 250VAC
/ Emergency Stop Button

| | |
|-------------|------------------------------|
| IRTU-ES 442 | Bas-Çevir / Push-Turn Ø30/NC |
| IRTU-ES 542 | Bas-Çevir / Push-Turn Ø40/NC |
| IRTU-ES 642 | Bas-Çevir / Push-Turn Ø60/NC |
| IRTU-ES 142 | Anahtarlı / With Key Ø40/NC |
| IRTU-BS 542 | Bas-Çevir / Push-Turn / NC |
| IRTU-BC 420 | Yaylı / Push / NC |
| IRTU-BS 142 | Anahtarlı / With Key / NC |
| IRTU-EC 210 | Beyaz / White / NO |
| IRTU-EC 310 | Yeşil / Green / NO |
| IRTU-EC 420 | Kırmızı / Red / NC |

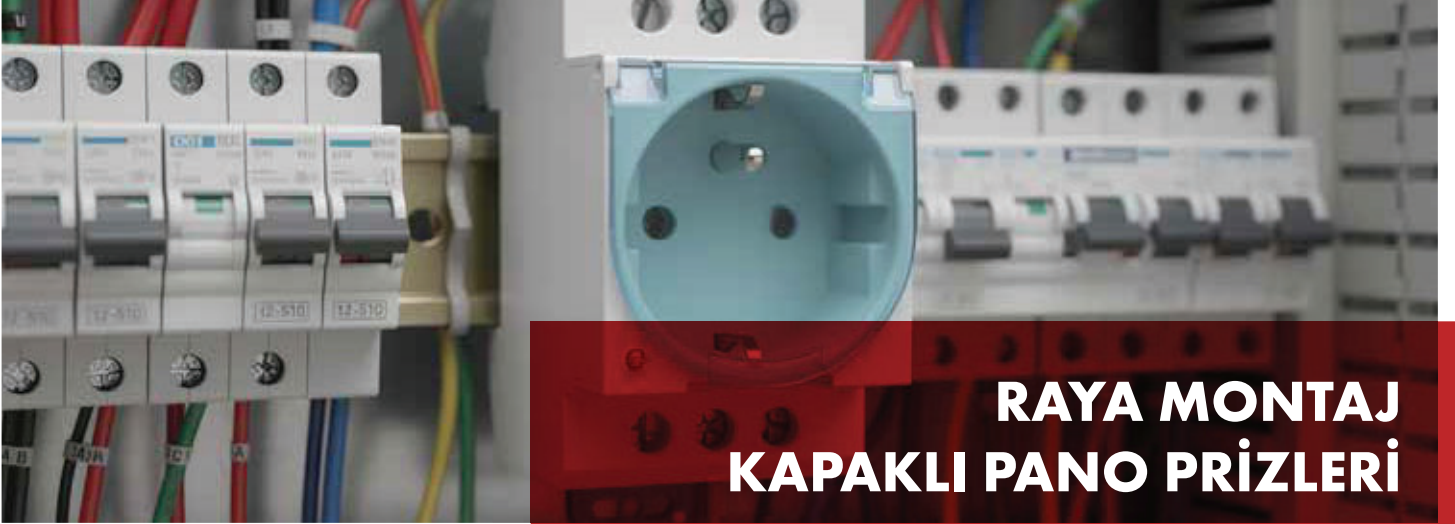

RAYA MONTAJ KAPAKLI PANO PRİZLERİ



| Kod / Code | Ürün Tanımı / Product Name | Koli Adedi / Box Qty. | Birim Fiyat (Adet/pcs) |
|------------|--|-----------------------|------------------------|
| IRTU-7160 | Tek Giriş LED'siz Topraklı / Inlet Without LED | 10 | 232,70 TL |
| IRTU-7162 | Tek Giriş LED'li Topraklı / Inlet With LED | 10 | 300,00 TL |
| IRTU-7164 | Tek Giriş Ledsiz UPS'li / Inlet & UPS With LED | 10 | 246,00 TL |
| IRTU-7166 | Tek Giriş LED'li UPS'li / Inlet & UPS With LED | 10 | 265,00 TL |

| Kod / Code | Ürün Tanımı / Product Name | Koli Adedi / Box Qty. | Birim Fiyat (Adet/pcs) |
|------------|--|-----------------------|------------------------|
| IRTU-7161 | Çift Giriş LED'siz Topraklı / Inlet & Outled Without LED | 10 | 340,00 TL |
| IRTU-7163 | Çift Giriş LED'li Topraklı / Inlet With LED | 10 | 375,00 TL |
| IRTU-7165 | Çift Giriş LED'siz UPS'li / Inlet & Outled & UPS Without LED | 10 | 340,00 TL |
| IRTU-7167 | Çift Giriş LED'li UPS'li / Inlet & Outled & UPS With LED | 10 | 355,00 TL |

Yapışkanlı Pano Etiketleri / Panel Labels Adhesive



| Kod / Code | Ürün Tanımı / Product Name | Koli Adedi / Box Qty. | Birim Fiyat / Unit Price (Adet/pcs) |
|--------------|--------------------------------------|-----------------------|-------------------------------------|
| IRTU-PET3014 | PANO ETİKETİ / PANEL LABEL 30 x 14mm | 100 | 6,30 TL |
| IRTU-PET5214 | PANO ETİKETİ / PANEL LABEL 52 x 14mm | 100 | 7,00 TL |
| IRTU-PET3017 | PANO ETİKETİ / PANEL LABEL 30 x 17mm | 100 | 10,50 TL |
| IRTU-PET5217 | PANO ETİKETİ / PANEL LABEL 52 x 17mm | 100 | 11,40 TL |
| IRTU-PET7017 | PANO ETİKETİ / PANEL LABEL 70 x 17mm | 100 | 15,50 TL |

Plastik Pano Sinyal Etiketi / Plastic Panel Signal Label



| Kod / Code | Ürün Tanımı / Product Name | Koli Adedi / Box Qty. | Birim Fiyat / Unit Price (Adet/pcs) |
|---------------|--|-----------------------|-------------------------------------|
| IRTU-PSET3014 | PANO SİNYAL ETİKETİ 30x14 mm / PANEL SIGNAL LABEL 30x14 mm | 100 | 7,60 TL |
| IRTU-PSET3015 | PANO SİNYAL ETİKETİ 27x12 mm / PANEL SIGNAL LABEL 27x12 mm | 100 | 9,40 TL |
| IRTU-PSET3016 | PANO SİNYAL ETİKETİ 27x18 mm / PANEL SIGNAL LABEL 27x18 mm | 100 | 10,40 TL |
| IRTU-PSET3017 | PANO SİNYAL ETİKETİ 27x12 mm / PANEL SIGNAL LABEL 27x12 mm | 100 | 8,60 TL |
| IRTU-PSET2816 | PANO SİNYAL ETİKETİ 28x16 mm / PANEL SIGNAL LABEL 28x16 mm | 100 | 9,30 TL |

Uyarı Etiketleri / Caution Labels



| Kod / Code | Ürün Tanımı / Product Name | Poşet Ad. / Box Qty | Birim Fiyat / Unit Price (Paket/Package) |
|-------------|---|---------------------|--|
| IRTU-ET1001 | L1-L2-L3 Bara Yapıştırma Etiketi / L1-L2-L3 Busbar Label 1,5 cm | 540 | 300,00 TL |
| IRTU-ET1002 | N Bara Yapıştırma Etiketi / N Busbar Label 1,5 cm | 540 | 300,00 TL |
| IRTU-ET1003 | Topraklama Etiketi / Grounding Label 1,5 cm | 540 | 300,00 TL |
| IRTU-ET2001 | L1-L2-L3 Bara Yapıştırma Etiketi / L1-L2-L3 Busbar Label 3 cm | 240 | 300,00 TL |
| IRTU-ET2002 | N Bara Yapıştırma Etiketi / N Busbar Label 3 cm | 240 | 300,00 TL |
| IRTU-ET2003 | Topraklama Etiketi / Grounding Label 3 cm | 240 | 300,00 TL |
| IRTU-ET3001 | Tehlike Etiketi / Danger Label 10 x 10 x 10 cm | 100 | 1.045,00 TL |

Otomat Altı Etiket / Automat Label



3M Bant kullanılmaktadır.



| Kod / Code | Ürün Tanımı / Product Name | Koli Adedi / Box Qty. (mt) | Birim Fiyat / Unit Price (mt) |
|------------------|--|----------------------------|-------------------------------|
| IRTU-YPE20200.3M | 20 x 2000 mm YAPIŞKANLI PANO ETİKETİ / PANEL LABEL WITH STICKY | 200 | 3,20 € |
| IRTU-YPE30200.3M | 30 x 2000 mm YAPIŞKANLI PANO ETİKETİ / PANEL LABEL WITH STICKY | 100 | 3,60 € |
| IRTU-YPE40200.3M | 40 x 2000 mm YAPIŞKANLI PANO ETİKETİ / PANEL LABEL WITH STICKY | 100 | 3,70 € |
| IRTU-YPE7126 | 15 x 1000 mm YAPIŞKANLI PANO ETİKETİ / PANEL LABEL WITH STICKY | 50 | 4,20 € |
| IRTU-YPE7127 | 15 x 2000 mm YAPIŞKANLI PANO ETİKETİ / PANEL LABEL WITH STICKY | 50 | 4,20 € |

W Otomat Örtü Aparatı (Mt) / W Automat Cover Plate (Mt)



| Kod / Code | Ürün Tanımı / Product Name | Koli Adedi / Box Qty. (mt) | Birim Fiyat / Unit Price (mt) |
|--------------|--|----------------------------|-------------------------------|
| IRTU-WCP7035 | 2 MT ÖRTÜ PLAKASI RAL 7035 / 2 MT COVER PLATE RAL 7035 | 60 | 3,60 € |
| IRTU-WCP7032 | 2 MT ÖRTÜ PLAKASI RAL 70352 2 MT COVER PLATE RAL 7032 | 60 | 3,60 € |
| IRTU-WCP9001 | 2 MT ÖRTÜ PLAKASI RAL 9001 / 2 MT COVER PLATE RAL 9001 | 60 | 3,60 € |
| IRTU-WCP9003 | 2 MT ÖRTÜ PLAKASI RAL 9003 / 2 MT COVER PLATE RAL 9003 | 60 | 3,60 € |

W Otomat Parçalı Örtü Aparatı / W Automat Cover Plate with Parts



| Kod / Code | Ürün Tanımı / Product Name | Koli Adedi / Box Qty. (ad.) | Birim Fiyat / Unit Price (adet/pcs) |
|-----------------|---|-----------------------------|-------------------------------------|
| IRTU-WCPP7035 | 10'LU RAL 7035 / 10 PIECES RAL 7035 | 100 | 84,00 TL |
| IRTU-WCPP7035-E | 10'LU RAL 7035 / 10 GROUPS RAL 7035 (ESNEK-MOBLLEN) | 100 | 61,80 TL |
| IRTU-WCPP7035-L | 12-Lİ RAL 7035 / 10 GROUPS RAL 7035 (ESNEK-UYUMLU) | 50 | 70,00 TL |
| IRTU-WCPP9003-L | 12-Lİ RAL 9003 / 10 GROUPS RAL 9003 (ESNEK-UYUMLU) | 50 | 70,00 TL |

Pano Etiket Ayağı / Panel Label Leg (Polyamide 6 V0)









| Kod / Code | Ürün Tanımı / Product Name | Renk / Color | Koli Adedi / Box Qty. | Birim Fiyat / Unit Price (adet/pcs) |
|--------------|----------------------------|--------------|-----------------------|-------------------------------------|
| IRTU-PAY1001 | PLASTİK AYAK / PLASTIC LEG | RAL 7035 | 200 | 51,80 TL |

PVC Etiketler / PVC Labels

| Görsel / Icon | Kod / Code | Ürün Tanımı / Product Name | Koli Adedi / Box Qty. | Birim Fiyat Unit Price (Adet/pcs) |
|--|------------|---|-----------------------|-----------------------------------|
|  | IRTU-PVC1 | 14 x 20 mm 0,50 PVC Etiket Arkası Tamamen Çift Taraflı Bantlı / 14 x 20 mm 0,50 PVC Label Back Side With Double - Sided Tape | 250 | 34,20 TL |
|  | IRTU-PVC2 | 14 x 20 mm 0,50 PVC Etiket Arkası Tamamen Çift Taraflı Bantlı / 14 x 20 mm 0,50 PVC Label Back Side With Double - Sided Tape | 250 | 34,20 TL |
|  | IRTU-PVC3 | 14 x 20 mm 0,50 PVC Etiket Arkası Tamamen Çift Taraflı Bantlı / 14 x 20 mm 0,50 PVC Label Back Side With Double - Sided Tape | 250 | 34,20 TL |
|  | IRTU-PVC5 | 14 x 20 mm 50 Micron PVC Etiket Arkası Tamamen Çift Taraflı Bantlı / 14 x 20 mm 0,50 PVC Label Back Side With Double - Sided Tape | 250 | 34,20 TL |
|  | IRTU-PVC6 | 14 x 20 mm 50 Micron PVC Etiket Arkası Tamamen Çift Taraflı Bantlı / 14 x 20 mm 0,50 PVC Label Back Side With Double - Sided Tape | 250 | 34,20 TL |
|  | IRTU-PVC13 | 14 x 20 mm 50 Micron PVC Etiket Arkası Tamamen Çift Taraflı Bantlı / 14 x 20 mm 0,50 PVC Label Back Side With Double - Sided Tape | 250 | 34,20 TL |

Sac Levha Etiketleri / Sheet Metal Labels

| Görsel / Icon | Kod / Code | Ürün Tanımı / Product Name | Koli Adedi / Box Qty. | Birim Fiyat Unit Price (Adet/pcs) |
|---|------------|---------------------------------|-----------------------|-----------------------------------|
|  | IRTU-SAC4 | 14 x 20 Sac Levha / Sheet Metal | 250 | 38,00 TL |
|  | IRTU-SAC7 | 12 x 15 Sac Levha / Sheet Metal | 250 | 38,00 TL |
|  | IRTU-SAC8 | 14 x 20 Sac Levha / Sheet Metal | 250 | 38,00 TL |
|  | IRTU-SAC9 | 14 x 20 Sac Levha / Sheet Metal | 250 | 38,00 TL |
|  | IRTU-SAC10 | 14 x 20 Sac Levha / Sheet Metal | 250 | 38,00 TL |
|  | IRTU-SAC12 | 14 x 20 Sac Levha / Sheet Metal | 250 | 38,00 TL |

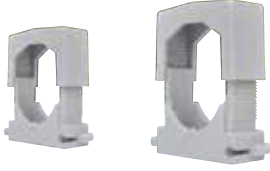
Tırnaklı Kroşeler (Plastik) / Plastic Click-fit Cable Clips

| Kod / Code | Ürün Tanımı / Product Name | Kutu Adedi / Box Qty | Birim Fiyat Unit Price (adet/pcs) |
|------------|--|----------------------|-----------------------------------|
| IRTU-5155 | No. 1 Tırnaklı Kroşe / Plastic Click-fit Cable Clips 2 x 1.5 / 2 x 2.5 / 2 x 4 / 2 x 6 3 x 1.5 / 4 x 1.5 / 3 x 2.5 / 4 x 2.5 | 100 | 33,70 TL |
| IRTU-5156 | No. 2 Tırnaklı Kroşe / Plastic Click-fit Cable Clips 4 x 4 / 4 x 6 | 100 | 41,20 TL |
| IRTU-5157 | No. 3 Tırnaklı Kroşe / Plastic Click-fit Cable Clips 4 x 10 NYM / 3 x 16 + 10 NYY | 100 | 44,00 TL |
| IRTU-5158 | No. 4 Tırnaklı Kroşe / Plastic Click-fit Cable Clips 3 x 25 + 16 / 3 x 35 + 16 / 3 x 50 + 25 NYY | 25 | 45,50 TL |

Boru / Kablo Sabitleyiciler / Pipe and Cable Fixing Elements

| Kod / Code | Ürün Tanımı / Product Name | Kutu Adedi / Box Qty | Birim Fiyat Unit Price (adet/pcs) |
|------------|---|----------------------|-----------------------------------|
| IRTU-9001 | Boru ve kablo Sabitleyicisi / Pipe and Cable Fixing Elements (8-36) | 750 | 31,50 TL |
| IRTU-9002 | Boru ve kablo Sabitleyicisi / Pipe and Cable Fixing Elements (14-48) | 250 | 132,00 TL |
| IRTU-9003 | Boru ve kablo Sabitleyicisi / Pipe and Cable Fixing Elements (24-72) | 250 | 232,00 TL |

Boru / Kablo Bağlantı Rayları / Pipe and Cable Connection Rail

| Kod / Code | Ürün Tanımı / Product Name | Kutu Adedi / Box Qty | Birim Fiyat Unit Price (mt/mt) |
|-------------|---|----------------------|--------------------------------|
| IRTU-MR9001 | Galvaniz Ray / Galvanized Rail (8-36) (2 mt) | 100 | |
| IRTU-MR9002 | Galvaniz Ray / Galvanized Rail (14-48 / 24-72) (2 mt) | 100 | |

PG Polyamid Körtapa / PG Polyamide Blindstop



| Kod / Code | Ölçü / Size | Renk / Color | Kutu Adedi / Box Qty. | Birim Fiyatı / Unit Price (Adet/pcs) |
|-------------|-------------|--------------|-----------------------|--------------------------------------|
| IRTU-KT1007 | PG-7 | ■ ■ | 250 | |
| IRTU-KT1009 | PG-9 | ■ ■ | 250 | |
| IRTU-KT1011 | PG-11 | ■ ■ | 250 | |
| IRTU-KT1013 | PG-13,5 | ■ ■ | 250 | |
| IRTU-KT1016 | PG-16 | ■ ■ | 250 | |
| IRTU-KT1021 | PG-21 | ■ ■ | 250 | |
| IRTU-KT1029 | PG-29 | ■ ■ | 150 | |
| IRTU-KT1036 | PG-36 | ■ ■ | 100 | |

Kauçuk Körtapa / Rubber Blindstop



DÜZ TİP / FLAT TYPE



| Kod / Code | Ölçü / Size | Kutu Adedi / Box Qty. | Birim Fiyatı / Unit Price (Adet/pcs) |
|----------------|--|-----------------------|--------------------------------------|
| IRTU-KT5013 | PG-13,5 | 100 | 9,00 TL |
| IRTU-KT5016 | PG-16 | 100 | 9,90 TL |
| IRTU-KT5021 | PG-21 | 100 | 12,30 TL |
| IRTU-KT5029 | PG-29 | 100 | 19,80 TL |
| IRTU-KT5036 | PG-36 | 100 | 48,30 TL |
| IRTU-KT5042 | PG-42 | 50 | 59,50 TL |
| IRTU-KT5016.01 | PG-16 | 100 | 9,90 TL |
| IRTU-TAPA1001 | Plastik Tapa (Rivet) / Plastic Plug (Rivets) | 1000 | 4,00 TL |
| IRTU-PUL1001 | Plastik Perde Vidası Pulu | 1000 | 8,00 TL |

Pano Havalandırma Aparatı / Panel Air Conditioning Equipments



PHV1001



PHV1003



PHV1002

| Kod / Code | Ölçüler / Dimensions | Boy / Size | Kutu Adedi / Box Qty. | Birim Fiyatı / Unit Price (adet/pcs) |
|--------------|--|------------|-----------------------|--------------------------------------|
| IRTU-PHV1001 | Pano Havalandırma Aparatı / Panel Air Conditioning Equipment | M 40 x 1,5 | 50 | 105,00 TL |
| IRTU-PHV1002 | Drenaj Tapası / Drainage Equipment | Ø 16 | 100 | |
| IRTU-PHV1003 | Drenaj Tapası / Drainage Equipment | M 25 x 1,5 | 50 | |

Pano Proje Cebi / Panel Project Pocket



| Kod / Code | Ürün Tanımı / Product Name | Boy / Size | Renk/ Colour | Koli Adedi / Box Qty. | Birim Fiyat / Unit Price (Adet/pcs) |
|-------------|--|--------------------|--------------|-----------------------|-------------------------------------|
| IRTU-PCB303 | Pano Proje Cebi / Panel Project Pocket | Bantsız / Tapeless | RAL7032 | 50 | 150,00 TL |
| IRTU-PCB403 | Pano Proje Cebi / Panel Project Pocket | Bantlı / Banded | RAL7032 | 50 | 165,00 TL |
| IRTU-PCB304 | Pano Proje Cebi / Panel Project Pocket | Bantsız / Tapeless | RAL7035 | 50 | 150,00 TL |
| IRTU-PCB404 | Pano Proje Cebi / Panel Project Pocket | Bantlı / Banded | RAL7035 | 50 | 165,00 TL |
| IRTU-PCB305 | Pano Proje Cebi / Panel Project Pocket | Bantsız / Tapeless | RAL9001 | 50 | 150,00 TL |
| IRTU-PCB405 | Pano Proje Cebi / Panel Project Pocket | Bantlı / Banded | RAL9001 | 50 | 165,00 TL |
| IRTU-PCB310 | Pano Proje Cebi / Panel Project Pocket | Bantsız / Tapeless | RAL9003 | 50 | 150,00 TL |
| IRTU-PCB410 | Pano Proje Cebi / Panel Project Pocket | Bantlı / Banded | RAL9003 | 50 | 165,00 TL |



| | | | | | |
|-------------|--|--------------------|---------|----|-----------|
| IRTU-PCB603 | Pano Proje Cebi / Panel Project Pocket | Bantsız / Tapeless | RAL7032 | 60 | 115,00 TL |
| IRTU-PCB503 | Pano Proje Cebi / Panel Project Pocket | Bantlı / Banded | RAL7032 | 60 | 120,00 TL |
| IRTU-PCB604 | Pano Proje Cebi / Panel Project Pocket | Bantsız / Tapeless | RAL7035 | 60 | 115,00 TL |
| IRTU-PCB504 | Pano Proje Cebi / Panel Project Pocket | Bantlı / Banded | RAL7035 | 60 | 120,00 TL |
| IRTU-PCB605 | Pano Proje Cebi / Panel Project Pocket | Bantsız / Tapeless | RAL9001 | 60 | 115,00 TL |
| IRTU-PCB505 | Pano Proje Cebi / Panel Project Pocket | Bantlı / Banded | RAL9001 | 60 | 120,00 TL |
| IRTU-PCB610 | Pano Proje Cebi / Panel Project Pocket | Bantsız / Tapeless | RAL9003 | 60 | 115,00 TL |
| IRTU-PCB510 | Pano Proje Cebi / Panel Project Pocket | Bantlı / Banded | RAL9003 | 60 | 120,00 TL |



| Kod / Code | Ölçüler / Dimensions | Kutu Adedi / Box Qty | Birim Fiyat / Unit Price (adet/pcs) |
|--------------|------------------------------|----------------------|-------------------------------------|
| IRTU-PHV2001 | ELYAFLI / FIBER 120 x 120 mm | 50 | |
| IRTU-PHV2002 | ELYAFLI / FIBER 225 x 225 mm | 50 | |

Pano İçi Isıtma ve Soğutma Termostatları / Heating and Cooling Thermostats Inside Board



| Kod / Code | Ürün Tanımı / Product Name | Kutu Adedi / Box Qty. | Birim Fiyat / Unit Price (Adet/pcs) |
|--------------|--|-----------------------|-------------------------------------|
| IRTU-KTO1010 | Pano İçi Isıtma Termostatı (0-60 °C) / Panel Internal Heat Thermostat (0-60 °C) | 1 | |
| IRTU-KTO1020 | Pano İçi Soğutma Termostatı (0-60 °C) / Panel Internal Cold Thermostat (0-60 °C) | 1 | |
| IRTU-KTO1030 | Pano İçi Isıtma-Soğutma Termostatı (0-60 °C) / Panel Internal Heat-Cold Thermostat (0-60 °C) | 1 | |

Makine Kapak Kulparı / Machine Holder



| Kod / Code | Ürün Tanımı / Product Name | Ölçü / Size | Kutu Ad. / Box Qty | Birim Fiyat / Unit Price (tkm/set) |
|------------|--|-------------|--------------------|------------------------------------|
| IRTU-KP200 | Makine Kapak Kulbu L: 200 mm / Machine Handle L: 200 mm | 200 | 10 | |
| IRTU-KP300 | Makine Kapak Kulbu L: 300 mm / Machine Handle L: 300 mm | 300 | 10 | |
| IRTU-KP400 | Makine Kapak Kulbu L: 400 mm / Machine Handle L: 400 mm | 400 | 10 | |
| IRTU-KP500 | Makine Kapak Kulbu L: 500 mm / Machine Handle L: 500 mm | 500 | 10 | |
| IRTU-KP100 | Makine Kapak Kulbu Kenar Parçası / Machine Handle Part 1 | 500 | 10 | |
| IRTU-KP050 | Geçme Kapak Tutamağı - Elçek / Machine Handle Part 2 | 500 | 10 | |

Pano Perde Civatası / Panel Screen Screw



| Kod / Code | Ürün Tanımı / Product Name | Kutu Ad. / Box Qty | Birim Fiyat / Unit Price (tkm/set) |
|-------------|--|--------------------|------------------------------------|
| IRTU-PV0610 | M6x10 Pano Perde Civatası / CurtainWall M6x10 Bolt | 500 | |
| IRTU-PV0620 | M6x20 Pano Perde Civatası / CurtainWall M6x20 Bolt | 500 | |
| IRTU-PV0630 | M6x30 Pano Perde Civatası / CurtainWall M6x30 Bolt | 500 | |
| IRTU-PV1620 | M6x20 Tornavida Başlı Civata / M6x20 Bolt Head Screwdriver | 500 | |
| IRTU-PV1625 | M6x25 Tornavida Başlı Civata / M6x25 Bolt Head Screwdriver | 500 | |
| IRTU-PV1630 | M6x30 Tornavida Başlı Civata / M6x30 Bolt Head Screwdriver | 500 | |
| STPC-1011 | Plastik Armut Kulp / Plastic Handle | 500 | |

Plastik Cam Tutucu / Panel Glass Holder



| Kod / Code | Ürün Tanımı / Product Name | Kutu Adedi / Box Qty | Birim Fiyat / Unit Price (Adet/pcs) |
|------------------|--|----------------------|-------------------------------------|
| IRTU-CAMTUT 1010 | Alçak Tip Cam Tutucu / Low Type Glass Holder | 200 | 24,00 TL |
| IRTU-CAMTUT 1020 | Yüksek Tip Cam Tutucu / High Type Glass Holder | 200 | 32,00 TL |
| IRTU-4195 | Sağ Sol Köşe Aparatı | 100 | |
| IRTU-SK0010 | Sürgü Kilit | 0.8 - 1.5 mm | |
| IRTU-SK0020 | Mini Sürgü Kilit | 0.8 - 1.5 mm | |

BAĞLANTI EKİPMANLARI



YÜKSÜKLER

- Standart Yüksükler.
- Çatal Tip Yüksükler.
- Yuvarlak Tip Kablo Ucu.
- İğne Tip Kablo Ucu.
- Dişi Faston Kablo Uçları.



KABLO PAPUÇLARI

- Standart Kablo Papuçları.
- Kaynaklı Kablo Papuçları.
- Aliminyum Skp.
- Aliminyum - Bakır EK Muflar.
- KJB Tip Metalik Bağlantı Uçları.



KABLO TOPLAYICILAR

- Kablo Çorapları.
- Helezon Kablo Spiralleri.
- Isı İle Daralan Makaronlar.
- Silikon Makaronlar.
- Kablo Bağları.



BAĞLANTI AKSESUARLARI

- Pano Fırçaları.
- Pano Fitol ve Contaları.
- Kablo Kanalları.
- Pirinç ve Polyamid Rakorlar.
- Spiral Boru ve Rakorları.



MONTAJ RAYLARI

- Pano İçi Montaj Rayları.
- MG Tip Montaj Rayları.
- Profil Destek Rayları.
- Ray Taşıyıcılar.
- Ray Yükseltme Aparatları.

İzoleli Tek Girişli Yüksükler / Insulated Single Cord End Terminals

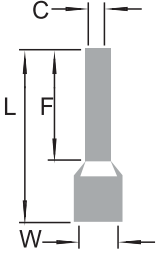

| Kod 1 / Code 1 | Alman Norm / German Norm | Kod 2 / Code 2 | Fransız Norm / French Norm | Kablo Kesiti / Cable Cross Section | Ölçüler / Dimension | | | | Kutu Adedi / Box Qty. | Birim Fiyat / Unit Price (adet / pcs) |
|----------------|--------------------------|-----------------|----------------------------|------------------------------------|---------------------|------|------|------|-----------------------|---------------------------------------|
| | | | | | F | L | C | W | | |
| IRTU-IYT005008 | | IRTU-IYT005008F | | 0.50 mm ² | 8,0 | 14,0 | 1,00 | 2,60 | 1000 | 0,633 TL |
| IRTU-IYT007508 | | IRTU-IYT007508F | | 0.75 mm ² | 8,0 | 14,0 | 1,2 | 2,8 | 1000 | 0,633 TL |
| IRTU-IYT010008 | | IRTU-IYT010008F | | 1.00 mm ² | 8,0 | 14,0 | 1,4 | 3,0 | 1000 | 0,633 TL |
| IRTU-IYT015008 | | IRTU-IYT015008F | | 1.50 mm ² | 8,0 | 14,0 | 1,7 | 3,5 | 1000 | 0,701 TL |
| IRTU-IYT025008 | | IRTU-IYT025008F | | 2.50 mm ² | 8,0 | 14,0 | 2,2 | 4,2 | 500 | 0,897 TL |
| IRTU-IYT040010 | | IRTU-IYT040010F | | 4.00 mm ² | 10,0 | 17,0 | 2,8 | 2,8 | 500 | 1,495 TL |
| IRTU-IYT060012 | | IRTU-IYT060012F | | 6.00 mm ² | 12,0 | 20,0 | 3,5 | 6,3 | 250 | 2,070 TL |
| IRTU-IYT100012 | | IRTU-IYT100012F | | 10.00 mm ² | 12,0 | 22,0 | 4,5 | 7,6 | 100 | 2,588 TL |
| IRTU-IYT160012 | | IRTU-IYT160012F | | 16.00 mm ² | 12,0 | 24,0 | 5,8 | 8,8 | 100 | 3,565 TL |
| IRTU-IYT250016 | | IRTU-IYT250016F | | 25.00 mm ² | 16,0 | 30,0 | 7,3 | 11,0 | 50 | 5,980 TL |
| IRTU-IYT350016 | | IRTU-IYT350016F | | 35.00 mm ² | 16,0 | 30,0 | 7,3 | 11,2 | 50 | 7,475 TL |
| IRTU-IYT500020 | | IRTU-IYT500020F | | 50.00 mm ² | 20,0 | 36,0 | 10,3 | 15,0 | 25 | 13,800 TL |
| IRTU-IYT700021 | | IRTU-IYT700021F | | 70.00 mm ² | 21,0 | 37,0 | 13,5 | 16,0 | 25 | 25,300 TL |
| IRTU-IYT950025 | | IRTU-IYT950025F | | 95.00 mm ² | 25,0 | 44,0 | 14,7 | 18,0 | 25 | |

İzoleli Çift Girişli Yüksükler DIN 46228 / Insulated Twin Cord End Terminals DIN 46228

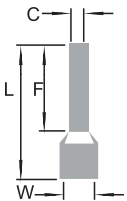

| Kod 1 / Code 1 | Alman Norm / German Norm | Kod 2 / Code 2 | Fransız Norm / French Norm | Kablo Kesiti / Cable Cross Section | Ölçüler / Dimension | | | | Kutu Adedi / Box Qty. | Birim Fiyat / Unit Price (adet / pcs) |
|-----------------|--------------------------|------------------|----------------------------|------------------------------------|---------------------|------|------|------------|-----------------------|---------------------------------------|
| | | | | | F | L | C | W | | |
| IRTU-IYC2007508 | | IRTU-IYC2007508F | | 2x0.75 mm ² | 8,0 | 15,0 | 1,8 | 2.8 / 5.0 | 500 | 1,208 TL |
| IRTU-IYC2010008 | | IRTU-IYC2010008F | | 2x1.0 mm ² | 8,0 | 15,0 | 2,05 | 3.4 / 5.4 | 500 | 1,265 TL |
| IRTU-IYC2015008 | | IRTU-IYC2015008F | | 2x1.5 mm ² | 8,0 | 16,0 | 2,3 | 3.6 / 6.6 | 500 | 1,553 TL |
| IRTU-IYC2025010 | | IRTU-IYC2025010F | | 2x2.5 mm ² | 10,0 | 18,5 | 2,8 | 4.2 / 7.8 | 250 | 2,473 TL |
| IRTU-IYC2040012 | | IRTU-IYC2040012F | | 2x4.0 mm ² | 12,0 | 23,0 | 3,7 | 4.9 / 8.8 | 200 | 2,875 TL |
| IRTU-IYC2060014 | | IRTU-IYC2060014F | | 2x6.0 mm ² | 14,0 | 26,0 | 4,8 | 6.9 / 10.0 | 100 | 3,565 TL |
| IRTU-IYC2100014 | | IRTU-IYC2100014F | | 2x10.0 mm ² | 14,0 | 26,5 | 6,4 | 7.6 / 12.8 | 50 | 5,463 TL |
| IRTU-IYC2160014 | | IRTU-IYC2160014F | | 2x16.0 mm ² | 14,0 | 31,5 | 0,3 | 9.6 / 18.6 | 50 | 6,900 TL |

Bakır Malzemeden Kalay Kaplı, Polyamid İzoleli -40°C + 150°C Çalışma Sıcaklığı DIN 46228

Tin-Plated Copper Material, Polyamide Insulated -40 °C to + 150 °C Operating Temperature DIN 46228

İzoleli Yuvarlak Tip Kablo Ucu DIN 46228 / Insulated Ring Type End Terminals DIN 46228



| Kod / Code | Renk / Color | Kablo Kesiti Cable Cross Section | Metrik Ölçüsü (d2) | Ölçüler / Dimensions | | | | | | Kutu Ad. Box Qty | Birim Fiyat Unit / Price (adet/pcs) |
|----------------|--------------|--|-----------------------|----------------------|------|------|------|-----|-----|---------------------|---|
| | | | | B | L | F | E | D | d1 | | |
| IRTU-IY0503255 | ■ | 0,5-1,5 mm ² | 3,2 | 5,5 | 16,7 | 4,0 | 10,0 | 4,1 | 1,7 | 200 | 2,070 TL |
| IRTU-IY0504380 | | | 4,3 | 8,0 | 21,0 | 7,0 | | | | | 2,990 TL |
| IRTU-IY0505380 | | | 5,3 | 8,0 | 21,0 | 7,0 | | | | | 3,048 TL |
| IRTU-IY0506511 | | | 6,5 | 11,6 | 26,8 | 11,1 | | | | | 4,830 TL |
| IRTU-IY0508411 | | | 8,4 | 11,6 | 26,8 | 11,1 | | | | | 4,830 TL |
| IRTU-IY1503264 | ■ | 1,25-2,5 mm ² | 3,2 | 6,4 | 17,5 | 4,3 | 10,0 | 4,5 | 2,3 | 200 | 3,680 TL |
| IRTU-IY1504366 | | | 4,3 | 6,6 | 19,6 | 6,3 | | | | | 3,680 TL |
| IRTU-IY1505385 | | | 5,3 | 8,5 | 22,0 | 7,8 | | | | | 3,795 TL |
| IRTU-IY1506512 | | | 6,5 | 12,0 | 27,0 | 11,0 | | | | | 5,405 TL |
| IRTU-IY1508412 | | | 8,4 | 12,0 | 27,0 | 11,0 | | | | | 5,405 TL |
| IRTU-IY1510513 | | | 10,5 | 13,6 | 30,7 | 13,9 | | | | | 100 |
| IRTU-IY4004372 | ■ | 4,0-6,0 mm ² | 4,3 | 7,2 | 22,0 | 5,9 | 12,5 | 6,5 | 3,4 | 100 | 7,820 TL |
| IRTU-IY4005395 | | | 5,3 | 9,5 | 25,5 | 8,3 | | | | | 7,820 TL |
| IRTU-IY4006512 | | | 6,5 | 12,0 | 29,0 | 10,5 | | | | | 8,855 TL |
| IRTU-IY4008415 | | | 8,4 | 15,0 | 33,7 | 13,7 | | | | | 11,500 TL |
| IRTU-IY4010515 | | | 10,5 | 15,0 | 33,7 | 13,7 | | | | | 11,500 TL |
| IRTU-IY4013019 | | | 12,4 | 19,2 | 38,1 | 16,0 | | | | | 11,730 TL |
| IRTU-IY8005515 | ■ | 8,0-10,0 mm ² | 6,7 | 12,0 | 32,5 | 9,7 | | | | 50 | 12,880 TL |
| IRTU-IY8008415 | | | 8,4 | 15,0 | 38,0 | 13,8 | | | | | 15,525 TL |

İzoleli Çatal Tip Kablo Ucu DIN 46237 / Insulated Fork Type End Terminals DIN 46237

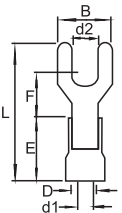

| Kod / Code | Renk / Color | Kablo Kesiti Cable Cross Section | Metrik Ölçüsü Metric Size (d2) | Ölçüler / Dimensions | | | | | | Kutu Ad. Box Qty | Birim Fiyat Unit / Price (adet/pcs) |
|----------------|--------------|--|--------------------------------------|----------------------|------|------|------|-----|-----|---------------------|---|
| | | | | B | L | F | E | D | d1 | | |
| IRTU-IC0503258 | ■ | 0,5-1,5 mm ² | 3,2 | 5,8 | 21,0 | 6,3 | 10,0 | 4,1 | 1,7 | 200 | 2,760 TL |
| IRTU-IC0504372 | | | 4,3 | 7,2 | 21,0 | 6,3 | | | | | 2,818 TL |
| IRTU-IC0505395 | | | 5,3 | 9,5 | 21,0 | 7,0 | | | | | 2,933 TL |
| IRTU-IC0506512 | | | 6,5 | 12,0 | 27,2 | 11,0 | | | | | 3,335 TL |
| IRTU-IC1503258 | ■ | 1,5-2,5 mm ² | 3,2 | 5,8 | 21,0 | 6,3 | 10,0 | 4,5 | 2,3 | 200 | 3,048 TL |
| IRTU-IC1504364 | | | 4,3 | 6,4 | 21,0 | 6,3 | | | | | 3,163 TL |
| IRTU-IC1505395 | | | 5,3 | 9,5 | 22,0 | 7,2 | | | | | 3,278 TL |
| IRTU-IC1506512 | | | 6,5 | 12,0 | 27,2 | 11,0 | | | | | 4,255 TL |
| IRTU-IC4004385 | ■ | 4,0 - 6,0 mm ² | 4,3 | 8,5 | 25,2 | 7,5 | 12,5 | 6,5 | 3,4 | 100 | 6,900 TL |
| IRTU-IC4005395 | | | 5,3 | 9,5 | 25,2 | 7,5 | | | | | 6,900 TL |
| IRTU-IC4006595 | | | 6,5 | 9,5 | 25,2 | 7,5 | | | | | 9,200 TL |

* Bakır malzemeden kalay kaplı, PVC izoleli, 105°C çalışma sıcaklığı, 600 Volt enerjiye dayanma özelliği

* Copper material, tin-plated, PVC insulated, operating temperature 105°C, 600 Volt energy withstand capability.

DIN NORMU 46235 TİP SKP SIKMALI KABLO PABUÇLARI (BAKIR)
DIN 46235 Standard Compression Cable Lugs (Copper)

| Kod / Code | Kablo Kesiti / Cable CrossSection (mm ²) | Civata (Ø) | ØD1 (mm) | ØD2 (mm) | L (mm) | ØD3 (mm) | A (mm) | C1 (mm) | C2 (mm) | a (mm) | s (mm) | Kutu Adedi / Box Qty. | Birim Fiyat / Unit Price (adet / pcs) |
|------------|--|---------------|-------------|-------------|-----------|-------------|-----------|------------|------------|-----------|-----------|--------------------------|---|
| IRTU-6052 | 10 | M5 | 6,5 | 5 | 34 | 5,5 | 9,5 | 7 | 8,5 | 1,5 | 13 | 800 | 19,00 TL |
| IRTU-6053 | | M6 | 6,5 | 5 | 34 | 6,5 | 9,5 | 7 | 8,5 | 1,5 | 13 | | |
| IRTU-6054 | 16 | M6 | 8,5 | 5,5 | 46 | 6,5 | 13 | 10 | 8 | 2 | 21 | 275 | 54,70 TL |
| IRTU-6055 | | M8 | 8,5 | 5,5 | 46 | 8,5 | 13 | 10 | 10 | 2 | 21 | | |
| IRTU-6056 | | M10 | 8,5 | 5,5 | 46 | 10,5 | 13 | 10 | 12 | 2 | 21 | | |
| IRTU-6057 | 25 | M6 | 10 | 7 | 48 | 6,5 | 16 | 10 | 8 | 3 | 21 | 250 | 66,60 TL |
| IRTU-6058 | | M8 | 10 | 7 | 48 | 8,5 | 16 | 10 | 10 | 3 | 21 | | |
| IRTU-6059 | | M10 | 10 | 7 | 48 | 10,5 | 16 | 10 | 12 | 3 | 21 | | |
| IRTU-6106 | | M12 | 10 | 7 | 48 | 13 | 16 | 10 | 13 | 3 | 21 | | |
| IRTU-6061 | 35 | M8 | 12,5 | 8,2 | 54 | 8,5 | 19 | 12 | 10 | 4,3 | 22 | 150 | 131,00 TL |
| IRTU-6062 | | M10 | 12,5 | 8,2 | 54 | 10,5 | 19 | 12 | 12 | 4,3 | 22 | | |
| IRTU-6063 | | M12 | 12,5 | 8,2 | 54 | 13 | 19 | 12 | 13 | 4,3 | 22 | | |
| IRTU-6064 | 50 | M8 | 14,5 | 10 | 64 | 8,5 | 21,5 | 12 | 10 | 4,5 | 31 | 75 | 193,50 TL |
| IRTU-6065 | | M10 | 14,5 | 10 | 64 | 10,5 | 21,5 | 12 | 12 | 4,5 | 31 | | |
| IRTU-6066 | | M12 | 14,5 | 10 | 64 | 13 | 21,5 | 12 | 13 | 4,5 | 31 | | |
| IRTU-6067 | | M16 | 14,5 | 10 | 64 | 17 | 21,5 | 12 | 16 | 4,5 | 31 | | |
| IRTU-6068 | 70 | M8 | 16,5 | 11,5 | 68 | 8,5 | 23,8 | 13 | 10 | 5 | 32 | 50 | 248,30 TL |
| IRTU-6069 | | M10 | 16,5 | 11,5 | 68 | 10,5 | 23,8 | 13 | 12 | 5 | 32 | | |
| IRTU-6070 | | M12 | 16,5 | 11,5 | 68 | 13 | 23,8 | 13 | 13 | 5 | 32 | | |
| IRTU-6072 | | M16 | 16,5 | 11,5 | 68 | 17 | 23,8 | 13 | 16 | 5 | 32 | | |
| IRTU-6074 | 95 | M10 | 19 | 13,5 | 78,5 | 10,5 | 27 | 14 | 12 | 5,5 | 40 | 40 | 372,00 TL |
| IRTU-6075 | | M12 | 19 | 13,5 | 78,5 | 13 | 27 | 14 | 14 | 5,5 | 40 | | |
| IRTU-6077 | | M16 | 19 | 13,5 | 78,5 | 17 | 27 | 14 | 16 | 5,5 | 40 | | |
| IRTU-6078 | 120 | M10 | 21 | 15,5 | 86 | 10,5 | 30 | 16,5 | 16 | 5,5 | 40 | 30 | 467,80 TL |
| IRTU-6079 | | M12 | 21 | 15,5 | 86 | 13 | 30 | 16,5 | 16,5 | 5,5 | 40 | | |
| IRTU-6081 | | M16 | 21 | 15,5 | 86 | 17 | 30 | 16,5 | 20 | 5,5 | 40 | | |
| IRTU-6082 | | M20 | 21 | 15,5 | 86 | 20,5 | 30 | 16,5 | 22 | 5,5 | 40 | | |
| IRTU-6083 | 150 | M10 | 23,5 | 17 | 94 | 10,5 | 34 | 16 | 16 | 6,5 | 40 | 25 | 691,60 TL |
| IRTU-6084 | | M12 | 23,5 | 17 | 94 | 13 | 34 | 16 | 17 | 6,5 | 40 | | |
| IRTU-6086 | | M16 | 23,5 | 17 | 94 | 17 | 34 | 16 | 20 | 6,5 | 40 | | |
| IRTU-6087 | | M20 | 23,5 | 17 | 94 | 20,5 | 34 | 16 | 22 | 6,5 | 40 | | |
| IRTU-6088 | 185 | M10 | 25,5 | 19 | 98 | 10,5 | 37 | 16 | 16 | 6,5 | 40 | 20 | 812,00 TL |
| IRTU-6089 | | M12 | 25,5 | 19 | 98 | 13 | 37 | 16 | 17 | 6,5 | 40 | | |
| IRTU-6091 | | M16 | 25,5 | 19 | 98 | 17 | 37 | 16 | 20 | 6,5 | 40 | | |
| IRTU-6092 | | M20 | 25,5 | 19 | 98 | 20,5 | 37 | 16 | 22 | 6,5 | 40 | | |
| IRTU-6094 | 240 | M12 | 29 | 21,5 | 108 | 13 | 42 | 16 | 17 | 7,5 | 55 | 15 | 1.123,00 TL |
| IRTU-6096 | | M16 | 29 | 21,5 | 108 | 17 | 42 | 16 | 20 | 7,5 | 55 | | |
| IRTU-6097 | | M20 | 29 | 21,5 | 108 | 20,5 | 42 | 16 | 22 | 7,5 | 55 | | |
| IRTU-6098 | 300 | M14 | 32 | 24,5 | 119 | 14,5 | 48 | 19 | 22 | 7,5 | 55 | 10 | 1.316,00 TL |
| IRTU-6099 | | M16 | 32 | 24,5 | 119 | 17 | 48 | 19 | 22 | 7,5 | 55 | | |
| IRTU-6100 | | M20 | 32 | 24,5 | 119 | 20,5 | 48 | 19 | 22 | 7,5 | 55 | | |
| IRTU-6101 | 400 | M14 | 38,5 | 27,5 | 140 | 14,5 | 55 | 19 | 22 | 11 | 60 | 5 | 1.764,49 TL |
| IRTU-6102 | | M16 | 38,5 | 27,5 | 140 | 17 | 55 | 19 | 22 | 11 | 60 | | |
| IRTU-6103 | | M20 | 38,5 | 27,5 | 140 | 20,5 | 55 | 19 | 22 | 11 | 60 | | |

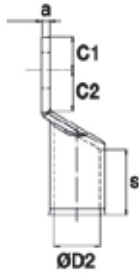
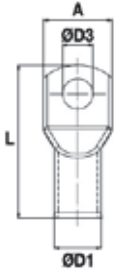

STANDART SKP SIKMALI KABLO PABUÇLARI (BAKIR)
Standard Compression Cable Lugs (Copper)

| Kod / Code | Kablo Kesiti / Cable CrossSection (mm ²) | Civata (Ø) | ØD1 (mm) | ØD2 (mm) | L (mm) | ØD3 (mm) | A (mm) | C1 (mm) | C2 (mm) | a (mm) | s (mm) | Kutu Adedi / Box Qty. | Birim Fiyat / Unit Price (adet / pcs) |
|------------|--|------------|----------|----------|--------|----------|--------|---------|---------|--------|--------|-----------------------|---------------------------------------|
| ONKA-6250 | 6 | M5 | 5,5 | 4 | 24 | 5,5 | 7,9 | 6 | 5 | 1,5 | 9 | 1500 | 11,82 TL |
| ONKA-0232 | | M6 | 5,5 | 4 | 24 | 6,5 | 7,9 | 6 | 5 | 1,5 | 9 | | |
| ONKA-6251 | 10 | M5 | 6,5 | 5 | 24,9 | 5,3 | 9,4 | 5,7 | 6,3 | 1,5 | 9 | 1250 | 15,55 TL |
| ONKA-0234 | | M6 | 6,5 | 5 | 24,9 | 6,5 | 9,4 | 5,7 | 6,3 | 1,5 | 9 | | |
| ONKA-6252 | 16 | M6 | 7 | 5,5 | 27,7 | 6,5 | 10,3 | 6,4 | 5,6 | 1,5 | 10 | 750 | 17,80 TL |
| ONKA-0035 | | M8 | 7 | 5,5 | 28,3 | 8,5 | 12,7 | 6,4 | 6,7 | 1 | 10 | | |
| ONKA-0241 | 25 | M6 | 9 | 7,5 | 34 | 6,5 | 13,4 | 7,5 | 8,5 | 1,5 | 11,5 | 450 | 26,73 TL |
| ONKA-6253 | | M8 | 9 | 7,5 | 34 | 8,4 | 13,4 | 7,5 | 8,5 | 1,5 | 11,5 | | |
| ONKA-0245 | 35 | M6 | 10,5 | 8,5 | 39 | 6,5 | 15,6 | 8,7 | 9,3 | 2 | 14 | 300 | 44,83 TL |
| ONKA-6254 | | M8 | 10,5 | 8,5 | 39 | 8,5 | 15,6 | 8,7 | 9,3 | 2 | 14 | | |
| ONKA-0246 | | M10 | 10,5 | 8,5 | 39 | 10,5 | 15,6 | 8,7 | 9,3 | 2 | 14 | | |
| ONKA-0249 | 50 | M8 | 12 | 10 | 46,6 | 8,5 | 17,8 | 10,3 | 11,2 | 2 | 17 | 175 | 59,10 TL |
| ONKA-6255 | | M10 | 12 | 10 | 46,6 | 10,5 | 17,8 | 10,3 | 11,2 | 2 | 17 | | |
| ONKA-0250 | | M12 | 12 | 10 | 46,6 | 13 | 17,8 | 10,3 | 11,2 | 2 | 17 | | |
| ONKA-0251 | | M14 | 12 | 10 | 46,6 | 14,5 | 17,8 | 10,3 | 11,2 | 2 | 17 | | |
| ONKA-0254 | 70 | M8 | 14 | 11,5 | 49,2 | 8,5 | 20,4 | 10,7 | 10,8 | 2,5 | 17 | 125 | 89,64 TL |
| ONKA-6256 | | M10 | 14 | 11,5 | 49,2 | 10,5 | 20,4 | 10,7 | 10,8 | 2,5 | 17 | | |
| ONKA-0255 | | M12 | 14 | 11,5 | 49,2 | 13 | 20,4 | 10,7 | 10,8 | 2,5 | 17 | | |
| ONKA-0256 | | M14 | 14 | 11,5 | 49,2 | 14,5 | 20,4 | 10,7 | 10,8 | 2,5 | 17 | | |
| ONKA-0259 | 95 | M8 | 16 | 13,5 | 53,5 | 10,5 | 23,7 | 10,3 | 11,7 | 2,5 | 21 | 75 | 114,70 TL |
| ONKA-6257 | | M10 | 16 | 13,5 | 53,5 | 13 | 23,7 | 10,3 | 11,7 | 2,5 | 21 | | |
| ONKA-0260 | | M12 | 16 | 13,5 | 53,5 | 14,5 | 23,7 | 10,3 | 11,7 | 2,5 | 21 | | |
| ONKA-0261 | | M14 | 16 | 13,5 | 53,5 | 17 | 23,7 | 10,3 | 11,7 | 2,5 | 21 | | |
| ONKA-0267 | 120 | M10 | 18 | 15,5 | 64 | 10,5 | 27 | 13,7 | 13,3 | 2,5 | 24 | 50 | 160,05 TL |
| ONKA-6258 | | M12 | 18 | 15,5 | 64 | 13 | 27 | 13,7 | 13,3 | 2,5 | 24 | | |
| ONKA-0268 | | M14 | 18 | 15,5 | 64 | 14,5 | 27 | 13,7 | 13,3 | 2,5 | 24 | | |
| ONKA-0269 | | M16 | 18 | 15,5 | 64 | 17 | 27 | 13,7 | 13,3 | 2,5 | 24 | | |
| ONKA-0274 | 150 | M10 | 20 | 16,5 | 71,2 | 10,5 | 29,4 | 17,4 | 16,6 | 3,5 | 24 | 40 | 263,40 TL |
| ONKA-6259 | | M12 | 20 | 16,5 | 71,2 | 13 | 29,4 | 17,4 | 16,6 | 3,5 | 24 | | |
| ONKA-0275 | | M14 | 20 | 16,5 | 71,2 | 14,5 | 29,4 | 17,4 | 16,6 | 3,5 | 24 | | |
| ONKA-0276 | | M16 | 20 | 16,5 | 71,2 | 17 | 29,4 | 17,4 | 16,6 | 3,5 | 24 | | |
| ONKA-0281 | 185 | M10 | 22 | 18,5 | 77 | 10,5 | 32,4 | 17,4 | 17,6 | 3,5 | 27 | 30 | 315,90 TL |
| ONKA-0282 | | M12 | 22 | 18,5 | 77 | 13 | 32,4 | 17,4 | 17,6 | 3,5 | 27 | | |
| ONKA-0283 | | M14 | 22 | 18,5 | 77 | 14,5 | 32,4 | 17,4 | 17,6 | 3,5 | 27 | | |
| ONKA-6260 | | M16 | 22 | 18,5 | 77 | 17 | 32,4 | 17,4 | 17,6 | 3,5 | 27 | | |
| ONKA-0285 | | M20 | 22 | 18,5 | 77 | 20,5 | 32,4 | 17,4 | 17,6 | 3,5 | 27 | | |
| ONKA-2756 | 240 | M10 | 25,5 | 21,5 | 83,5 | 10,5 | 37,6 | 17,4 | 17,6 | 4 | 32 | 25 | 441,70 TL |
| ONKA-0289 | | M12 | 25,5 | 21,5 | 83,5 | 13 | 37,6 | 17,4 | 17,6 | 4 | 32 | | |
| ONKA-2757 | | M14 | 25,5 | 21,5 | 83,5 | 14,5 | 37,6 | 17,4 | 17,6 | 4 | 32 | | |
| ONKA-6261 | | M16 | 25,5 | 21,5 | 83,5 | 17 | 37,6 | 17,4 | 17,6 | 4 | 32 | | |
| ONKA-0291 | | | | 25,5 | 21,5 | 83,5 | 20,5 | 37,6 | 17,4 | 17,6 | 4 | | |

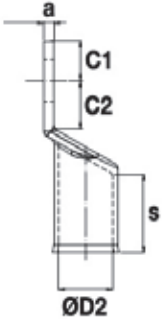
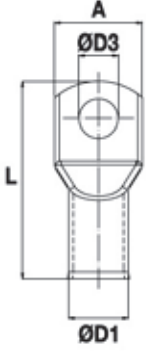

EXTRA STANDART SKP SIKMALI KABLO PABUÇLARI (UZUN ve KALIN TİP) (BAKIR)
Extra Standard Compression Cable Lugs (Long & Heavy-Duty Type) (Copper)

| Kod / Code | Kablo Kesiti / Cable CrossSection (mm ²) | Civata (Ø) | ØD1 (mm) | ØD2 (mm) | L (mm) | ØD3 (mm) | A (mm) | C1 (mm) | C2 (mm) | a (mm) | s (mm) | Kutu Adedi / Box Qty. | Birim Fiyat / (adet / pcs) |
|------------|--|---------------|-------------|-------------|-----------|-------------|-----------|------------|------------|-----------|-----------|--------------------------|-------------------------------|
| ONKA-6025 | 6 | M5 | 5,5 | 4 | 25,7 | 5,5 | 7,9 | 6 | 5 | 1,5 | 11 | 1500 | 14,36 TL |
| ONKA-0030 | | M6 | 5,5 | 4 | 25,7 | 6,5 | 7,9 | 6 | 5 | 1,5 | 11 | | |
| ONKA-6026 | 10 | M5 | 6,5 | 5 | 27,3 | 5,5 | 9,5 | 5,6 | 6,4 | 1,5 | 11 | 1000 | 16,08 TL |
| ONKA-0032 | | M6 | 6,5 | 5 | 27,3 | 6,5 | 9,5 | 5,6 | 6,4 | 1 | 11 | | |
| ONKA-6252 | 16 | M6 | 7,8 | 5,8 | 29,7 | 6,5 | 11,2 | 5,6 | 6,4 | 2 | 13 | 600 | 26,85 TL |
| ONKA-0035 | | M8 | 7,8 | 5,8 | 33,5 | 8,5 | 14 | 7,8 | 6,8 | 1,5 | 13 | | |
| ONKA-0039 | 25 | M6 | 9,5 | 7,2 | 40 | 6,5 | 13,5 | 7,3 | 8,3 | 2,3 | 17 | 300 | 44,30 TL |
| ONKA-6028 | | M8 | 9,5 | 7,2 | 40 | 8,5 | 13,5 | 7,3 | 8,3 | 2,3 | 17 | | |
| ONKA-0043 | 35 | M6 | 10,8 | 8,5 | 43,3 | 6,5 | 15,7 | 8,6 | 9,4 | 2,3 | 18 | 250 | 63,20 TL |
| ONKA-6029 | | M8 | 10,8 | 8,5 | 43,3 | 8,5 | 15,7 | 8,6 | 9,4 | 2,3 | 18 | | |
| ONKA-0044 | 50 | M10 | 10,8 | 8,5 | 43,3 | 10,5 | 15,7 | 8,6 | 9,4 | 2,3 | 18 | 150 | 99,15 TL |
| ONKA-0047 | | M8 | 13 | 10 | 51,2 | 8,5 | 18,7 | 10,5 | 11 | 3 | 22 | | |
| ONKA-6030 | | M10 | 13 | 10 | 51,2 | 10,5 | 18,7 | 10,5 | 11 | 3 | 22 | | |
| ONKA-0048 | | M12 | 13 | 10 | 51,2 | 13 | 18,7 | 10,5 | 11 | 3 | 22 | | |
| ONKA-0049 | 70 | M14 | 13 | 10 | 51,2 | 14,5 | 18,7 | 10,5 | 11 | 3 | 22 | 100 | 132,05 TL |
| ONKA-0052 | | M8 | 14,7 | 11,5 | 55 | 8,5 | 21,2 | 10,5 | 11 | 3,2 | 23 | | |
| ONKA-6031 | | M10 | 14,7 | 11,5 | 55 | 10,5 | 21,2 | 10,5 | 11 | 3,2 | 23 | | |
| ONKA-0053 | | M12 | 14,7 | 11,5 | 55 | 13 | 21,2 | 10,5 | 11 | 3,2 | 23 | | |
| ONKA-0054 | 95 | M14 | 14,7 | 11,5 | 55 | 14,5 | 21,2 | 10,5 | 11 | 3,2 | 23 | 75 | 157,80 TL |
| ONKA-0057 | | M8 | 16,7 | 13,5 | 59,6 | 8,5 | 24,5 | 10,5 | 11,5 | 3,2 | 25 | | |
| ONKA-6032 | | M10 | 16,7 | 13,5 | 59,6 | 10,5 | 24,5 | 10,5 | 11,5 | 3,2 | 25 | | |
| ONKA-0058 | | M12 | 16,7 | 13,5 | 59,6 | 13 | 24,5 | 10,5 | 11,5 | 3,2 | 25 | | |
| ONKA-0059 | 120 | M14 | 16,7 | 13,5 | 59,6 | 14,5 | 24,5 | 10,5 | 11,5 | 3,2 | 25 | 50 | 232,95 TL |
| ONKA-0065 | | M10 | 19 | 15,6 | 70,6 | 10,5 | 28 | 13,6 | 13,4 | 3,4 | 32 | | |
| ONKA-6033 | | M12 | 19 | 15,6 | 70,6 | 13 | 28 | 13,6 | 13,4 | 3,4 | 32 | | |
| ONKA-0066 | | M14 | 19 | 15,6 | 70,6 | 14,5 | 28 | 13,6 | 13,4 | 3,4 | 32 | | |
| ONKA-0067 | 150 | M16 | 19 | 15,6 | 70,6 | 17 | 28 | 13,6 | 13,4 | 3,4 | 32 | 40 | 318,20 TL |
| ONKA-0072 | | M10 | 21 | 17 | 77,6 | 10,5 | 30,6 | 17,6 | 16,4 | 4 | 32 | | |
| ONKA-6034 | | M12 | 21 | 17 | 77,6 | 13 | 30,6 | 17,6 | 16,4 | 4 | 32 | | |
| ONKA-0073 | | M14 | 21 | 17 | 77,6 | 14,5 | 30,6 | 17,6 | 16,4 | 4 | 32 | | |
| ONKA-0074 | 185 | M16 | 21 | 17 | 77,6 | 17 | 30,6 | 17,6 | 16,4 | 4 | 32 | 30 | 400,05 TL |
| ONKA-0079 | | M10 | 23 | 19 | 85 | 10,5 | 34 | 17,6 | 17,4 | 4 | 35 | | |
| ONKA-0080 | | M12 | 23 | 19 | 85 | 13 | 34 | 17,6 | 17,4 | 4 | 35 | | |
| ONKA-0081 | | M14 | 23 | 19 | 85 | 14,5 | 34 | 17,6 | 17,4 | 4 | 35 | | |
| ONKA-6035 | 240 | M16 | 23 | 19 | 85 | 17 | 34 | 17,6 | 17,4 | 4 | 35 | 25 | 587,50 TL |
| ONKA-0083 | | M20 | 23 | 19 | 85 | 20,5 | 34 | 17,6 | 17,4 | 4 | 35 | | |
| ONKA-0087 | | M10 | 26 | 21 | 90 | 10,5 | 37,8 | 17,6 | 17,4 | 5 | 35 | | |
| ONKA-0088 | | M12 | 26 | 21 | 90 | 13 | 37,8 | 17,6 | 17,4 | 5 | 35 | | |
| ONKA-0089 | 300 | M14 | 26 | 21 | 90 | 14,5 | 37,8 | 17,6 | 17,4 | 5 | 35 | 10 | 874,90 TL |
| ONKA-6036 | | M16 | 26 | 21 | 90 | 17 | 37,8 | 17,6 | 17,4 | 5 | 35 | | |
| ONKA-0091 | | M20 | 26 | 21 | 90 | 20,5 | 37,8 | 17,6 | 17,4 | 5 | 35 | | |
| ONKA-0094 | | M14 | 29 | 23,5 | 103 | 14,5 | 42 | 21,2 | 14,8 | 5,1 | 35 | | |
| ONKA-6037 | 400 | M16 | 29 | 23,5 | 103 | 17 | 42 | 21,2 | 14,8 | 5,1 | 35 | 10 | 1.240,00 TL |
| ONKA-0096 | | M20 | 29 | 23,5 | 103 | 20,5 | 42 | 21,2 | 14,8 | 5,1 | 35 | | |
| ONKA-0099 | 400 | M14 | 32,8 | 27 | 125 | 14,5 | 47,5 | 24 | 16 | 5,8 | 36 | 10 | 1.240,00 TL |
| ONKA-0100 | | M16 | 32,8 | 27 | 125 | 17 | 47,5 | 24 | 16 | 5,8 | 36 | | |
| ONKA-6038 | | M20 | 32,8 | 27 | 125 | 20,5 | 47,5 | 24 | 16 | 5,8 | 36 | | |

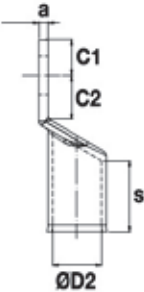
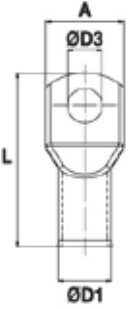

LONG BOY SKP SIKMALI KABLO PABUÇLARI (BAKIR)

Long Barrel Compression Cable Lugs (Copper)

| Kod / Code | Kablo Kesiti / Cable CrossSection (mm ²) | Civata (Ø) | ØD1 (mm) | ØD2 (mm) | L (mm) | ØD3 (mm) | A (mm) | C1 (mm) | C2 (mm) | a (mm) | s (mm) | Kutu Adedi / Box Qty. | Birim Fiyat / (adet / pcs) |
|------------|--|------------|----------|----------|--------|----------|--------|---------|---------|--------|--------|-----------------------|----------------------------|
| ONKA-6025 | 6 | M5 | 5,5 | 4 | 25,7 | 5,5 | 7,9 | 6 | 5 | 1,5 | 11 | 1500 | 14,36 TL |
| ONKA-0030 | | M6 | 5,5 | 4 | 25,7 | 6,5 | 7,9 | 6 | 5 | 1,5 | 11 | | |
| ONKA-6026 | 10 | M5 | 6,5 | 5 | 27,3 | 5,5 | 11,2 | 5,6 | 6,4 | 1,5 | 11 | 1000 | 16,08 TL |
| ONKA-0032 | | M6 | 6,5 | 5 | 27,3 | 6,5 | 11,2 | 5,6 | 6,4 | 1,5 | 11 | | |
| ONKA-6403 | 16 | M6 | 7 | 5,5 | 29,7 | 6,5 | 10,3 | 5,6 | 6,4 | 1,5 | 14 | 600 | 19,55 TL |
| ONKA-0294 | | M8 | 7 | 5,5 | 31 | 8,5 | 12,7 | 5,6 | 6,9 | 1,1 | 14 | | |
| ONKA-0297 | 25 | M6 | 9 | 7,5 | 40 | 6,5 | 13,4 | 7,3 | 8,3 | 1,5 | 16 | 300 | 30,60 TL |
| ONKA-6404 | | M8 | 9 | 7,5 | 40 | 8,5 | 13,4 | 7,3 | 8,3 | 1,5 | 16 | | |
| ONKA-2704 | 35 | M6 | 10,5 | 8,5 | 43,3 | 6,5 | 15,6 | 8,6 | 9,4 | 2 | 19 | 250 | 49,20 TL |
| ONKA-6405 | | M8 | 10,5 | 8,5 | 43,3 | 8,5 | 15,6 | 8,6 | 9,4 | 2 | 19 | | |
| ONKA-2705 | | M10 | 10,5 | 8,5 | 43,3 | 10,5 | 15,6 | 8,6 | 9,4 | 2 | 19 | | |
| ONKA-2708 | 50 | M8 | 12 | 10 | 51,2 | 8,5 | 17,8 | 10,5 | 11 | 2 | 22 | 150 | 66,60 TL |
| ONKA-6406 | | M10 | 12 | 10 | 51,2 | 10,5 | 17,8 | 10,5 | 11 | 2 | 22 | | |
| ONKA-2709 | | M12 | 12 | 10 | 51,2 | 13 | 17,8 | 10,5 | 11 | 2 | 22 | | |
| ONKA-2710 | | M14 | 12 | 10 | 51,2 | 14,5 | 17,8 | 10,5 | 11 | 2 | 22 | | |
| ONKA-2713 | 70 | M8 | 14 | 11,5 | 55 | 8,5 | 20,4 | 10,5 | 11 | 2,9 | 24 | 100 | 100,25 TL |
| ONKA-6407 | | M10 | 14 | 11,5 | 55 | 10,5 | 20,4 | 10,5 | 11 | 2,9 | 24 | | |
| ONKA-2714 | | M12 | 14 | 11,5 | 55 | 13 | 20,4 | 10,5 | 11 | 2,9 | 24 | | |
| ONKA-2715 | | M14 | 14 | 11,5 | 55 | 14,5 | 20,4 | 10,5 | 11 | 2,9 | 24 | | |
| ONKA-2717 | 95 | M8 | 16 | 13,5 | 59,6 | 8,5 | 23,7 | 10,5 | 11,5 | 2,6 | 27 | 75 | 127,70 TL |
| ONKA-6408 | | M10 | 16 | 13,5 | 59,6 | 10,5 | 23,7 | 10,5 | 11,5 | 2,6 | 27 | | |
| ONKA-2718 | | M12 | 16 | 13,5 | 59,6 | 13 | 23,7 | 10,5 | 11,5 | 2,6 | 27 | | |
| ONKA-2719 | | M14 | 16 | 13,5 | 59,6 | 14,5 | 23,7 | 10,5 | 11,5 | 2,6 | 27 | | |
| ONKA-2725 | 120 | M10 | 18 | 15,5 | 70,6 | 10,5 | 27 | 13,6 | 13,4 | 2,6 | 32 | 50 | 174,05 TL |
| ONKA-6409 | | M12 | 18 | 15,5 | 70,6 | 13 | 27 | 13,6 | 13,4 | 2,6 | 32 | | |
| ONKA-2726 | | M14 | 18 | 15,5 | 70,6 | 14,5 | 27 | 13,6 | 13,4 | 2,6 | 32 | | |
| ONKA-2727 | | M16 | 18 | 15,5 | 70,6 | 17 | 27 | 13,6 | 13,4 | 2,6 | 32 | | |
| ONKA-2732 | 150 | M10 | 20 | 16,5 | 77,6 | 10,5 | 29,4 | 17,6 | 16,4 | 3,4 | 30 | 40 | 276,70 TL |
| ONKA-6410 | | M12 | 20 | 16,5 | 77,6 | 13 | 29,4 | 17,6 | 16,4 | 3,4 | 30 | | |
| ONKA-2733 | | M14 | 20 | 16,5 | 77,6 | 14,5 | 29,4 | 17,6 | 16,4 | 3,4 | 30 | | |
| ONKA-2734 | | M16 | 20 | 16,5 | 77,6 | 17 | 29,4 | 17,6 | 16,4 | 3,4 | 30 | | |
| ONKA-2739 | 185 | M10 | 22 | 18,5 | 85 | 10,5 | 32,4 | 17,6 | 17,4 | 3,5 | 35 | 30 | 336,15 TL |
| ONKA-2740 | | M12 | 22 | 18,5 | 85 | 13 | 32,4 | 17,6 | 17,4 | 3,5 | 35 | | |
| ONKA-2741 | | M14 | 22 | 18,5 | 85 | 14,5 | 32,4 | 17,6 | 17,4 | 3,5 | 35 | | |
| ONKA-6411 | | M16 | 22 | 18,5 | 85 | 17 | 32,4 | 17,6 | 17,4 | 3,5 | 35 | | |
| ONKA-2743 | 240 | M20 | 22 | 18,5 | 85 | 20,5 | 32,4 | 17,6 | 17,4 | 3,5 | 35 | 25 | 465,50 TL |
| ONKA-2747 | | M10 | 25,5 | 21,5 | 90 | 10,5 | 37,6 | 17,6 | 17,4 | 4 | 40 | | |
| ONKA-2748 | | M12 | 25,5 | 21,5 | 90 | 13 | 37,6 | 17,6 | 17,4 | 4 | 40 | | |
| ONKA-2749 | | M14 | 25,5 | 21,5 | 90 | 14,5 | 37,6 | 17,6 | 17,4 | 4 | 40 | | |
| ONKA-6412 | | M16 | 25,5 | 21,5 | 90 | 17 | 37,6 | 17,6 | 17,4 | 4 | 40 | | |
| ONKA-2751 | | M20 | 25,5 | 21,5 | 90 | 20,5 | 37,6 | 17,6 | 17,4 | 4 | 40 | | |

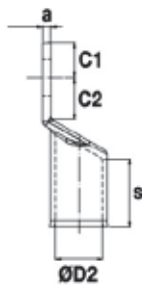
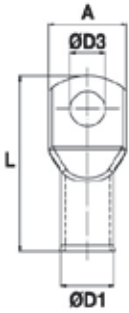

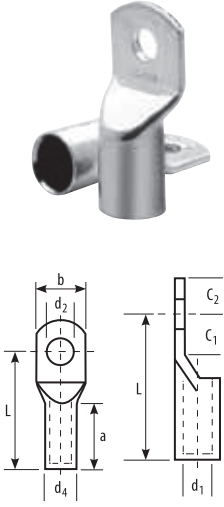
Standart SKP Kablo Pabucu (Eko Tip)
Standart Cable Lug (Eco Type)

| Kod / Code | Kablo Kesiti (mm ²) Cable Diameter (mm ²) | Civata Metric | Ölçüler / Dimension | | | | | | | | Koli Adedi Box Qty | Birim Fiyat Unit Price (adet/pcs) |
|-----------------|--|------------------|---------------------|------|------|------|------|------|------|------|-----------------------|---|
| | | | d1 | d4 | a | d2 | b | c1 | c2 | L | | |
| IRTU-SKPS01606E | 16 | M6 | 5,5 | 7 | 12,5 | 6,5 | 10,5 | 7,5 | 7,5 | 24 | 500 | |
| IRTU-SKPS02508E | 25 | M8 | 7 | 9 | 15,5 | 8,5 | 14 | 8,5 | 8,5 | 27,5 | 300 | |
| IRTU-SKPS03508E | 35 | M8 | 8,5 | 10,5 | 16,5 | 8,5 | 15,5 | 9,5 | 9,5 | 32 | 200 | |
| IRTU-SKPS05010E | 50 | M10 | 10 | 12 | 18 | 10,5 | 18 | 11 | 11 | 37,5 | 125 | |
| IRTU-SKPS07010E | 70 | M10 | 11,5 | 14 | 20 | 10,5 | 21 | 11 | 11 | 40 | 80 | |
| IRTU-SKPS09512E | 95 | M12 | 13,5 | 16 | 22 | 13,5 | 24 | 12,5 | 12,5 | 45 | 60 | |
| IRTU-SKPS12012E | 120 | M12 | 15,5 | 18 | 24 | 13,5 | 27 | 14 | 14 | 49 | 50 | |
| IRTU-SKPS15012E | 150 | M12 | 16,5 | 20 | 26 | 13 | 29 | 14 | 14 | 51,5 | 35 | |
| IRTU-SKPS18512E | 185 | M16 | 18,5 | 22 | 30,5 | 13 | 32 | 14,5 | 14,5 | 58,5 | 25 | |
| IRTU-SKPS24012E | 240 | M16 | 21,5 | 25,5 | 33,5 | 13 | 37,5 | 16 | 16 | 66 | 20 | |

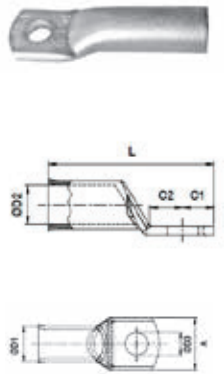
ALÜMİNYUM DIN NORMU SKP SIKMALI KABLO PABUÇLARI
Aluminum DIN Standard Compression Cable Lugs

| Kod / Code | Kablo Kesiti / Cable CrossSection (mm ²) | Civata (Ø) | ØD1 (mm) | ØD2 (mm) | L (mm) | ØD3 (mm) | A (mm) | C1 (mm) | C2 (mm) | Kutu Adedi / Box Qty. | Birim Fiyat / (adet / pcs) |
|------------|--|---------------|-------------|-------------|-----------|-------------|-----------|------------|------------|--------------------------|-------------------------------|
| IRTU-6122 | 10 | M5 | 8 | 5 | 50 | 5,5 | 9 | 7 | 8,5 | 300 | 18,30 TL |
| IRTU-6123 | 16 | M8 | 10 | 6 | 53 | 8,4 | 13,7 | 10 | 10 | 200 | 21,45 TL |
| IRTU-6124 | 25 | M8 | 12 | 7 | 62 | 8,4 | 16 | 10 | 10 | 100 | 25,50 TL |
| IRTU-6125 | 35 | M10 | 14 | 8,2 | 70 | 10,5 | 19 | 12 | 12 | 75 | 31,10 TL |
| IRTU-6126 | 50 | M10 | 16 | 10 | 80 | 10,5 | 22 | 12 | 12 | 50 | 36,90 TL |
| IRTU-6127 | 70 | M10 | 18 | 12 | 90 | 10,5 | 24 | 12 | 12 | 40 | 44,00 TL |
| IRTU-6128 | 95 | M12 | 22 | 13,4 | 95 | 13 | 28 | 13 | 13 | 25 | 69,20 TL |
| IRTU-6129 | 120 | M12 | 23 | 15 | 110 | 13 | 32 | 16 | 17 | 20 | 86,50 TL |
| IRTU-6130 | 150 | M12 | 26 | 16,5 | 114 | 13 | 34 | 16 | 17 | 15 | 101,60 TL |
| IRTU-6131 | 185 | M12 | 28 | 18,5 | 125 | 13 | 37 | 16 | 17 | 10 | 118,35 TL |
| IRTU-6132 | 240 | M12 | 32 | 20 | 140 | 13 | 42 | 16 | 17 | 8 | 156,20 TL |

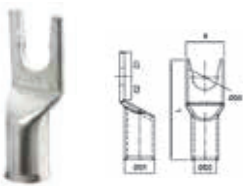
ÇATAL TİP SIKMALI KABLO PABUÇLARI
Fork Type Compression Cable Lugs

| Kod | Kablo Kesiti / Cable CrossSection (mm ²) | Civata (Ø) | ØD1 (mm) | ØD2 (mm) | L (mm) | ØD3 (mm) | A (mm) | C1 (mm) | C2 (mm) | Kutu Adedi / Box Qty. | Birim Fiyat / Unit Price (adet / pcs) |
|-----------|--|---------------|-------------|-------------|-----------|-------------|-----------|------------|------------|--------------------------|---|
| IRTU-6210 | 10 | M5 | 6,5 | 5 | 25 | 5,5 | 9,5 | 5,5 | 6,5 | 1250 | 18,15 TL |
| IRTU-6211 | 16 | M6 | 7 | 5,5 | 27,5 | 6,5 | 10,5 | 5,5 | 6,5 | 750 | 20,55 TL |
| IRTU-6212 | 25 | M8 | 9 | 7,5 | 34 | 8,5 | 13 | 7 | 9 | 450 | 29,20 TL |
| IRTU-6213 | 35 | M8 | 10,5 | 8,5 | 39 | 8,5 | 15,5 | 8,5 | 9,5 | 300 | 47,15 TL |
| IRTU-6214 | 50 | M8 | 12 | 10 | 47 | 8,5 | 18 | 10 | 11,5 | 175 | 61,00 TL |

45° SIKMALI KABLO PABUÇLARI
45° Bent Compression Cable Lugs



| Kod / Code | Kablo Kesiti / Cable CrossSection (mm ²) | Civata (Ø) | İç Çap (d1) (mm) | Dış Çap (d1) (mm) | Kablo Boyu (A) | Kutu Adedi / Box Qty. | Birim Fiyat / Unit Price (adet / pcs) |
|------------|--|------------|------------------|-------------------|----------------|-----------------------|---------------------------------------|
| IRTU-6306 | 16 | M 6/8/10 | 5.50 | 7.50 | 12.50 | 300 | |
| IRTU-6307 | 25 | M 8/10 | 7.00 | 9.50 | 15.50 | 200 | |
| IRTU-6308 | 35 | M 8/10 | 8.50 | 11.00 | 17.00 | 125 | |
| IRTU-6309 | 50 | M 10/12 | 10.00 | 13.00 | 18.50 | 80 | |
| IRTU-6310 | 70 | M 10/12 | 11.50 | 14.50 | 22.00 | 60 | |
| IRTU-6311 | 95 | M 10/12/14 | 13.50 | 16.50 | 24.00 | 40 | |
| IRTU-6312 | 120 | M 10/12/14 | 14.50 | 18.00 | 27.00 | 30 | |
| IRTU-6313 | 150 | M 10/12/16 | 16.50 | 21.00 | 29.00 | 25 | |
| IRTU-6314 | 185 | M 10/12/16 | 18.50 | 23.00 | 32.00 | 20 | |
| IRTU-6315 | 240 | M 10/12/16 | 21.00 | 26.00 | 37.00 | 15 | |
| IRTU-6316 | 300 | M 12/16 | 23.50 | 28.50 | 39.00 | 8 | |

90° SIKMALI KABLO PABUÇLARI
90° Bent Compression Cable Lugs



| Kod / Code | Kablo Kesiti / Cable CrossSection (mm ²) | Civata (Ø) | İç Çap (d1) (mm) | Dış Çap (d1) (mm) | Kablo Boyu (A) | Kutu Adedi / Box Qty. | Birim Fiyat / Unit Price (adet / pcs) |
|------------|--|------------|------------------|-------------------|----------------|-----------------------|---------------------------------------|
| IRTU-6321 | 16 | M 6/8/10 | 5.50 | 7.50 | 12.50 | 300 | |
| IRTU-6322 | 25 | M 8/10 | 7.00 | 9.50 | 15.50 | 200 | |
| IRTU-6323 | 35 | M 8/10 | 8.50 | 11.00 | 17.00 | 150 | |
| IRTU-6324 | 50 | M 10/12 | 10.00 | 13.00 | 18.50 | 80 | |
| IRTU-6325 | 70 | M 10/12 | 11.50 | 14.50 | 22.00 | 60 | |
| IRTU-6326 | 95 | M 10/12/14 | 13.50 | 16.50 | 24.00 | 50 | |
| IRTU-6327 | 120 | M 10/12/14 | 14.50 | 18.00 | 27.00 | 30 | |
| IRTU-6328 | 150 | M 10/12/16 | 16.50 | 21.00 | 29.00 | 25 | |
| IRTU-6329 | 185 | M 10/12/16 | 18.50 | 23.00 | 32.00 | 20 | |
| IRTU-6330 | 240 | M 10/12/16 | 21.00 | 26.00 | 37.00 | 15 | |
| IRTU-6331 | 300 | M 12/16 | 23.50 | 28.50 | 39.00 | 8 | |

STANDART SIKMALI EK MUFLAR (BAKIR)

Standard Compression Butt Connectors (Copper)

| Kod / Code | Kablo Kesiti / Cable CrossSection (mm ²) | ØD1 (mm) | ØD2 (mm) | L (mm) | Kutu Adedi / Box Qty. | Birim Fiyat / Unit Price (adet / pcs) |
|-------------|--|-------------|-------------|-----------|--------------------------|---|
| IRTU - 6141 | 10 | 6.5 | 5 | 25.5 | 750 | 18,35 TL |
| IRTU - 6142 | 16 | 7 | 5.5 | 28 | 500 | 20,80 TL |
| IRTU - 6143 | 25 | 9 | 7.5 | 34.5 | 300 | 30,45 TL |
| IRTU - 6144 | 35 | 10.5 | 8.5 | 39.5 | 200 | 51,45 TL |
| IRTU - 6145 | 50 | 12 | 10 | 47.5 | 150 | 65,30 TL |
| IRTU - 6146 | 70 | 14 | 11.5 | 49.5 | 100 | 100,15 TL |
| IRTU - 6147 | 95 | 16 | 13.5 | 53.5 | 75 | 122,95 TL |
| IRTU - 6148 | 120 | 18 | 15.5 | 64 | 50 | 170,25 TL |
| IRTU - 6149 | 150 | 20 | 16.5 | 70 | 35 | 280,95 TL |
| IRTU - 6150 | 185 | 22 | 18.5 | 75 | 25 | 329,50 TL |
| IRTU - 6151 | 240 | 25.5 | 21.5 | 83.5 | 15 | 478,65 TL |

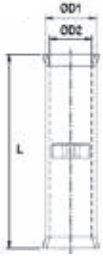

ALÜMİNYUM DIN NORMU SIKMALI EK MUFLAR

Aluminum DIN Standard Compression Butt Connectors

| Kod / Code | Kablo Kesiti / Cable CrossSection (mm ²) | ØD1 (mm) | ØD2 (mm) | L (mm) | Kutu Adedi / Box Qty. | Birim Fiyat / Unit Price (adet / pcs) |
|-------------|--|-------------|-------------|-----------|--------------------------|---|
| IRTU - 6270 | 10 | 8 | 5 | 52 | 300 | 12,85 TL |
| IRTU - 6271 | 16 | 10 | 6 | 55 | 250 | 15,20 TL |
| IRTU - 6272 | 25 | 12 | 7 | 64 | 150 | 19,55 TL |
| IRTU - 6273 | 35 | 14 | 8,2 | 72 | 75 | 25,35 TL |
| IRTU - 6274 | 50 | 16 | 10 | 82 | 50 | 33,05 TL |
| IRTU - 6275 | 70 | 18 | 12 | 92 | 35 | 39,50 TL |
| IRTU - 6276 | 95 | 22 | 13,4 | 97 | 20 | 63,90 TL |
| IRTU - 6277 | 120 | 23 | 15 | 112 | 15 | 75,35 TL |
| IRTU - 6278 | 150 | 26 | 16,5 | 116 | 8 | 103,95 TL |
| IRTU - 6279 | 185 | 28 | 18,5 | 127 | 7 | 118,90 TL |
| IRTU - 6280 | 240 | 32 | 20 | 142 | 5 | 178,35 TL |

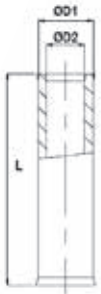

EKSTRA STANDART UZUN ve KALIN TİP SIKMALI EK MUFLAR (BAKIR)
Extra Standard Long & Heavy-Duty Type Compression Butt Connectors (Copper)

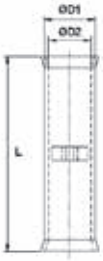

| Kod / Code | Kablo Kesiti / Cable CrossSection (mm ²) | ØD1 (mm) | ØD2 (mm) | L (mm) | Kutu Adedi / Box Qty. | Birim Fiyat / Unit Price (adet / pcs) |
|-------------|--|----------|----------|--------|-----------------------|---------------------------------------|
| IRTU - 6160 | 6 | 5.5 | 4 | 26.5 | 1000 | 16,90 TL |
| IRTU - 6161 | 10 | 6.5 | 5 | 28 | 750 | 18,85 TL |
| IRTU - 6162 | 16 | 7.8 | 5.8 | 30.5 | 500 | 21,20 TL |
| IRTU - 6163 | 25 | 9.5 | 7.2 | 40.5 | 400 | 48,80 TL |
| IRTU - 6164 | 35 | 10.8 | 8.5 | 44 | 250 | 68,00 TL |
| IRTU - 6165 | 50 | 13 | 10 | 50 | 150 | 108,90 TL |
| IRTU - 6166 | 70 | 14.7 | 11.5 | 55.5 | 100 | 142,50 TL |
| IRTU - 6167 | 95 | 16.7 | 13.5 | 59.5 | 75 | 168,05 TL |
| IRTU - 6168 | 120 | 19 | 15.6 | 65 | 50 | 247,95 TL |
| IRTU - 6169 | 150 | 21 | 17 | 70 | 35 | 343,30 TL |
| IRTU - 6170 | 185 | 23 | 19 | 75 | 25 | 435,60 TL |
| IRTU - 6171 | 240 | 26 | 21 | 85 | 20 | 632,70 TL |
| IRTU - 6172 | 300 | 28.6 | 23.5 | 100 | 12 | 904,90 TL |
| IRTU - 6173 | 400 | 32.8 | 27 | 110 | 10 | 1.278,00 TL |
| IRTU - 6174 | 500 | - | - | - | 10 | |
| IRTU - 6175 | 625 | - | - | - | 10 | |

DIN NORMU 46235 TİP SIKMALI EK MUFLAR (BAKIR)
DIN 46235 Standard Compression Butt Connectors (Copper)

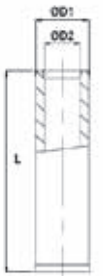



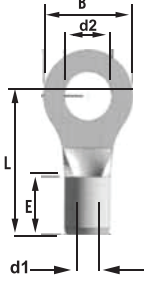



























| Kod / Code | Kablo Kesiti / Cable CrossSection (mm ²) | ØD1 (mm) | ØD2 (mm) | L (mm) | Kutu Adedi / Box Qty. | Birim Fiyat / Unit Price (adet / pcs) |
|-------------|--|----------|----------|--------|-----------------------|---------------------------------------|
| IRTU - 6181 | 10 | 6,5 | 5,0 | 30 | 400 | 19,20 TL |
| IRTU - 6182 | 16 | 8,5 | 5,5 | 50 | 250 | 63,75 TL |
| IRTU - 6183 | 25 | 10,0 | 7,0 | 50 | 125 | 74,05 TL |
| IRTU - 6184 | 35 | 12,5 | 8,2 | 50 | 100 | 130,55 TL |
| IRTU - 6185 | 50 | 14,5 | 10,0 | 56 | 100 | 181,40 TL |
| IRTU - 6186 | 70 | 16,5 | 11,5 | 56 | 50 | 220,80 TL |
| IRTU - 6187 | 95 | 19,0 | 13,5 | 70 | 40 | 346,70 TL |
| IRTU - 6188 | 120 | 21,0 | 15,5 | 70 | 30 | 382,10 TL |
| IRTU - 6189 | 150 | 23,5 | 17,0 | 80 | 20 | 572,95 TL |
| IRTU - 6190 | 185 | 25,5 | 19,0 | 85 | 10 | 682,85 TL |
| IRTU - 6191 | 240 | 29,0 | 21,5 | 90 | 10 | 952,50 TL |
| IRTU - 6192 | 300 | 32 | 24,5 | 100 | 10 | |
| IRTU - 6193 | 400 | 38,5 | 27,5 | 150 | 10 | |
| IRTU - 6194 | 500 | - | - | - | 10 | |
| IRTU - 6195 | 625 | - | - | - | 10 | |

DIN 46234 İzolesiz (kaynaklı) Yuvarlak Kablo Pabucu
 DIN 46234 Bare (welded) Round Cable Lug

| Kod / Code | Kablo Kesiti mm ² Cable Cross Section mm ² | Metrik Ölçüsü Metric Size | d1 | L | B | E | d2 | Koli Adedi Box Qty | Birim Fiyat Unit Price (Adet/pcs) |
|------------------|---|------------------------------|-----|------|------|------|------|-----------------------|---|
| IRTU-SKPAL001030 | 0,5 - 1 | M 3 | 1,6 | 10,8 | 6,0 | 4,8 | 3,2 | 1000 | |
| IRTU-SKPAL001035 | | M 3,5 | 1,6 | 10,8 | 6,0 | 4,8 | 3,7 | 1000 | |
| IRTU-SKPAL001040 | | M 4 | 1,6 | 11,8 | 8,0 | 4,8 | 4,3 | 1000 | |
| IRTU-SKPAL001050 | | M 5 | 1,6 | 12,8 | 10,0 | 4,8 | 5,3 | 1000 | |
| IRTU-SKPAL001060 | | M 6 | 1,6 | 14,8 | 11,0 | 4,8 | 6,5 | 1000 | |
| IRTU-SKPAL001080 | | M 8 | 1,6 | 17,0 | 14,0 | 4,8 | 8,4 | 1000 | |
| IRTU-SKPAL002030 | 1,5 - 2,5 | M 3 | 2,3 | 10,8 | 6,0 | 4,8 | 3,2 | 1000 | |
| IRTU-SKPAL002035 | | M 3,5 | 2,3 | 10,8 | 6,0 | 4,8 | 3,7 | 1000 | |
| IRTU-SKPAL002040 | | M 4 | 2,3 | 11,8 | 8,0 | 4,8 | 4,3 | 1000 | |
| IRTU-SKPAL002050 | | M 5 | 2,3 | 13,8 | 10,0 | 4,8 | 5,3 | 1000 | |
| IRTU-SKPAL002060 | | M 6 | 2,3 | 15,8 | 11,0 | 4,8 | 6,5 | 1000 | |
| IRTU-SKPAL002080 | | M 8 | 2,3 | 16,8 | 14,0 | 4,8 | 8,4 | 1000 | |
| IRTU-SKPAL002100 | | M 10 | 2,3 | 17,0 | 15,0 | 4,8 | 10,5 | 1000 | |
| IRTU-SKPAL002120 | | M 12 | 2,3 | 20 | 18 | 4,8 | 12 | 1000 | |
| IRTU-SKPAL004040 | 4,0 - 6,0 | M 4 | 3,6 | 14,0 | 8,0 | 6,0 | 4,3 | 100 | |
| IRTU-SKPAL004050 | | M 5 | 3,6 | 15,0 | 10,0 | 6,0 | 5,3 | 100 | |
| IRTU-SKPAL004060 | | M 6 | 3,6 | 16,0 | 11,0 | 6,0 | 6,5 | 100 | |
| IRTU-SKPAL004080 | | M 8 | 3,6 | 19,0 | 14,0 | 6,0 | 8,4 | 100 | |
| IRTU-SKPAL004100 | | M 10 | 3,6 | 21,0 | 18,0 | 6,0 | 10,5 | 100 | |
| IRTU-SKPAL004120 | | M 12 | 3,6 | 21,0 | 18,0 | 6,0 | 13,0 | 100 | |
| IRTU-SKPAL010050 | 10 | M 5 | 4,5 | 16,0 | 10,0 | 8,0 | 5,3 | 100 | |
| IRTU-SKPAL010060 | | M 6 | 4,5 | 17,0 | 11,0 | 8,0 | 6,5 | 100 | |
| IRTU-SKPAL010080 | | M 8 | 4,5 | 20,0 | 14,0 | 8,0 | 8,4 | 100 | |
| IRTU-SKPAL010100 | | M 10 | 4,5 | 21,0 | 18,0 | 8,0 | 10,5 | 100 | |
| IRTU-SKPAL010120 | | M 12 | 4,5 | 23,0 | 22,0 | 8,0 | 13,0 | 100 | |
| IRTU-SKPAL016050 | 16 | M 5 | 5,8 | 20,0 | 11,0 | 10,0 | 5,3 | 100 | |
| IRTU-SKPAL016060 | | M 6 | 5,8 | 20,0 | 11,0 | 10,0 | 6,5 | 100 | |
| IRTU-SKPAL016080 | | M 8 | 5,8 | 22,0 | 14,0 | 10,0 | 8,4 | 100 | |
| IRTU-SKPAL016100 | | M 10 | 5,8 | 24,0 | 18,0 | 10,0 | 10,5 | 100 | |
| IRTU-SKPAL016120 | | M 12 | 5,8 | 26,0 | 22,0 | 10,0 | 13,0 | 100 | |
| IRTU-SKPAL025050 | 25 | M 5 | 7,5 | 25,0 | 12,0 | 11,0 | 5,3 | 100 | |
| IRTU-SKPAL025060 | | M 6 | 7,5 | 25,0 | 12,0 | 11,0 | 6,5 | 100 | |
| IRTU-SKPAL025080 | | M 8 | 7,5 | 25,0 | 16,0 | 11,0 | 8,4 | 100 | |
| IRTU-SKPAL025100 | | M 10 | 7,5 | 26,0 | 18,0 | 11,0 | 10,5 | 100 | |
| IRTU-SKPAL025120 | | M 12 | 7,5 | 31,0 | 22,0 | 11,0 | 13,0 | 100 | |
| IRTU-SKPAL025160 | | M 16 | 7,5 | 35,0 | 28,0 | 11,0 | 17,0 | 100 | |



DIN 46234 İzolesiz (kaynaklı) Yuvarlak Kablo Pabucu
DIN 46234 Bare (welded Round Cable Lug)

| Kod / Code | Kablo Kesiti mm ² Cable Dia. mm ² | Metrik Ölçüsü Metric Size | d1 | L | B | E | d2 | Koli Adedi Box Qty | Birim Fiyat Unit Price (Adet/pcs) |
|------------------|--|---------------------------------|------|------|------|------|------|-----------------------|---|
| IRTU-SKPAL035060 | 35 | M 6 | 9,0 | 26,0 | 15,0 | 12,0 | 6,5 | 100 |  |
| IRTU-SKPAL035080 | | M 8 | 9,0 | 26,0 | 16,0 | 12,0 | 8,4 | 100 |  |
| IRTU-SKPAL035100 | | M 10 | 9,0 | 27,0 | 18,0 | 12,0 | 10,5 | 100 |  |
| IRTU-SKPAL035120 | | M 12 | 9,0 | 31,0 | 22,0 | 12,0 | 13,0 | 100 |  |
| IRTU-SKPAL035160 | | M 16 | 9,0 | 35,0 | 28,0 | 12,0 | 17,0 | 100 |  |
| IRTU-SKPAL050060 | 50 | M 6 | 11,0 | 34,0 | 18,0 | 16,0 | 6,5 | 100 |  |
| IRTU-SKPAL050080 | | M 8 | 11,0 | 34,0 | 18,0 | 16,0 | 8,4 | 100 |  |
| IRTU-SKPAL050100 | | M 10 | 11,0 | 34,0 | 18,0 | 16,0 | 10,5 | 100 |  |
| IRTU-SKPAL050120 | | M 12 | 11,0 | 36,0 | 22,0 | 16,0 | 13,0 | 100 |  |
| IRTU-SKPAL050160 | | M 16 | 11,0 | 40,0 | 22,0 | 16,0 | 17,0 | 100 |  |
| IRTU-SKPAL070060 | 70 | M 6 | 15,0 | 38,0 | 22,0 | 18,0 | 6,5 | 100 |  |
| IRTU-SKPAL070080 | | M 8 | 15,0 | 38,0 | 22,0 | 18,0 | 8,4 | 100 |  |
| IRTU-SKPAL070100 | | M 10 | 15,0 | 38,0 | 22,0 | 18,0 | 10,5 | 100 |  |
| IRTU-SKPAL070120 | | M 12 | 15,0 | 38,0 | 22,0 | 18,0 | 13,0 | 100 |  |
| IRTU-SKPAL070160 | | M 16 | 15,0 | 42,0 | 28,0 | 18,0 | 17,0 | 100 |  |
| IRTU-SKPAL095080 | 95 | M 8 | 15,0 | 42,0 | 24,0 | 20,0 | 8,4 | 100 |  |
| IRTU-SKPAL095100 | | M 10 | 15,0 | 42,0 | 24,0 | 20,0 | 10,5 | 100 |  |
| IRTU-SKPAL095120 | | M 12 | 15,0 | 42,0 | 24,0 | 20,0 | 13,0 | 100 |  |
| IRTU-SKPAL095160 | | M 16 | 15,0 | 44,0 | 28,0 | 20,0 | 17,0 | 100 |  |
| IRTU-SKPAL120080 | 120 | M 8 | 16,5 | 44,0 | 24,0 | 22,0 | 8,4 | 50 |  |
| IRTU-SKPAL120100 | | M 10 | 16,5 | 44,0 | 24,0 | 22,0 | 10,5 | 50 |  |
| IRTU-SKPAL120120 | | M 12 | 16,5 | 44,0 | 24,0 | 22,0 | 13,0 | 50 |  |
| IRTU-SKPAL120160 | | M 16 | 16,5 | 48,0 | 28,0 | 22,0 | 17,0 | 50 |  |
| IRTU-SKPAL150100 | 150 | M 10 | 19,0 | 50,0 | 30,0 | 24,0 | 10,5 | 50 |  |
| IRTU-SKPAL150120 | | M 12 | 19,0 | 50,0 | 30,0 | 24,0 | 13,0 | 50 |  |
| IRTU-SKPAL150160 | | M 16 | 19,0 | 50,0 | 30,0 | 24,0 | 17,0 | 50 |  |
| IRTU-SKPAL185120 | 185 | M 12 | 21,0 | 50,0 | 36,0 | 28,0 | 13,0 | 50 |  |
| IRTU-SKPAL185160 | | M 16 | 21,0 | 50,0 | 36,0 | 28,0 | 17,0 | 50 |  |
| IRTU-SKPAL240120 | 240 | M 12 | 23,5 | 56,0 | 38,0 | 32,0 | 13,0 | 50 |  |
| IRTU-SKPAL240160 | | M 16 | 23,5 | 56,0 | 38,0 | 32,0 | 17,0 | 50 |  |

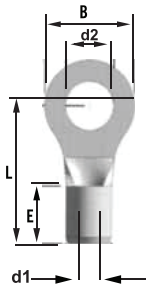

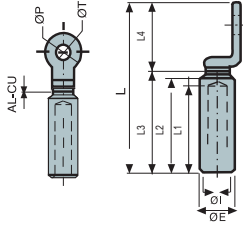
Bakır Alüminyumlu SKP (Bimetalik) / Bimetal (Al-Cu) Cable Lugs

| Kod / Code | Ref. No | K. Kesiti mm ² | ØE | ØI | L | L1 | L2 | L3 | L4 | ØT | ØP | Ağırlık | K. Ad. | Ad. / \$ |
|------------|----------|---------------------------|----|------|-----|----|-----|-----|----|-----|------|---------|--------|----------|
| IRTU-6108 | CAL-C16 | 16 | 16 | 5,5 | 82 | 38 | 48 | 52 | 30 | M8 | 10,5 | 7,2 | 30 | 3,20 \$ |
| IRTU-6109 | CAL-C25 | 25 | 16 | 6,5 | 82 | 38 | 48 | 52 | 30 | M8 | 10,5 | 7,2 | 30 | 3,20 \$ |
| IRTU-6110 | CAL-C35 | 35 | 16 | 8,2 | 82 | 38 | 48 | 52 | 30 | M8 | 10,5 | 7,2 | 30 | 3,20 \$ |
| IRTU-6111 | CAL-C50 | 50 | 20 | 9,7 | 88 | 43 | 48 | 52 | 36 | M10 | 10,5 | 7 | 30 | 4,20 \$ |
| IRTU-6112 | CAL-C70 | 70 | 20 | 11 | 88 | 43 | 48 | 52 | 36 | M10 | 10,5 | 7 | 30 | 4,20 \$ |
| IRTU-6113 | CAL-C95 | 95 | 20 | 12,5 | 88 | 43 | 48 | 52 | 36 | M10 | 10,5 | 6,3 | 30 | 4,20 \$ |
| IRTU-6114 | CAL-C120 | 120 | 25 | 13,7 | 110 | 60 | 64 | 68 | 44 | M10 | 10,5 | 13,5 | 30 | 6,50 \$ |
| IRTU-6115 | CAL-C150 | 150 | 25 | 15,5 | 110 | 60 | 64 | 68 | 44 | M10 | 10,5 | 12,2 | 30 | 6,50 \$ |
| IRTU-6116 | CAL-C185 | 185 | 32 | 17,5 | 120 | 60 | 64 | 70 | 50 | M12 | 10,5 | 20,1 | 30 | 10,70 \$ |
| IRTU-6117 | CAL-C240 | 240 | 32 | 19,5 | 120 | 60 | 64 | 70 | 50 | M12 | 10,5 | 22,6 | 15 | 10,70 \$ |
| IRTU-6118 | CAL-C300 | 300 | 40 | 23 | 160 | 93 | 101 | 108 | 52 | M12 | 13 | 33,4 | 9 | 17,50 \$ |
| IRTU-6119 | CAL-C400 | 400 | 40 | 26,2 | 160 | 93 | 101 | 108 | 52 | M12 | 13 | 30,2 | 9 | 1750 \$ |

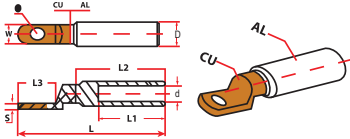
Bakır Alüminyumlu SKP (Bimetalik Uzun Tip) / Bimetal (Al-Cu) Cable Lugs

| Kod / Code | Ref. No | K. Kesiti mm ² | D | d | L±1 | L1 | L2 | L3 | W | Q | S | K. Ad. | Ad. / \$ |
|------------|----------|---------------------------|----|------|-----|----|-----|----|------|------|------|--------|----------|
| IRTU-6510 | CAL-M16 | 16 | 16 | 5,5 | 82 | 38 | 50 | 23 | 14,0 | 8,5 | 3,2 | 30 | 2,65 \$ |
| IRTU-6511 | CAL-M25 | 25 | 16 | 6,5 | 82 | 38 | 50 | 23 | 14,0 | 8,5 | 3,2 | 30 | 2,65 \$ |
| IRTU-6512 | CAL-M35 | 35 | 16 | 8,2 | 82 | 38 | 50 | 23 | 14,0 | 8,5 | 3,2 | 30 | 2,65 \$ |
| IRTU-6513 | CAL-M50 | 50 | 20 | 9,7 | 94 | 43 | 55 | 27 | 16,0 | 8,5 | 5,2 | 30 | 3,60 \$ |
| IRTU-6514 | CAL-M70 | 70 | 20 | 11 | 94 | 43 | 55 | 27 | 16,0 | 8,5 | 5,2 | 30 | 3,60 \$ |
| IRTU-6515 | CAL-M95 | 95 | 20 | 12,5 | 94 | 43 | 55 | 27 | 16,0 | 8,5 | 5,2 | 30 | 3,60 \$ |
| IRTU-6516 | CAL-M120 | 120 | 25 | 14,5 | 120 | 60 | 72 | 32 | 23,0 | 10,5 | 6,5 | 30 | 6,05 \$ |
| IRTU-6517 | CAL-M150 | 150 | 25 | 16,5 | 120 | 60 | 72 | 32 | 23,0 | 10,5 | 6,5 | 30 | 6,05 \$ |
| IRTU-6518 | CAL-M185 | 185 | 32 | 17,5 | 133 | 60 | 73 | 38 | 23,0 | 12,5 | 8 | 30 | 9,80 \$ |
| IRTU-6519 | CAL-M240 | 240 | 32 | 19,5 | 133 | 60 | 73 | 38 | 29,0 | 12,5 | 8 | 15 | 9,80 \$ |
| IRTU-6520 | CAL-M300 | 300 | 34 | 23 | 133 | 61 | 73 | 35 | 29,0 | 12,5 | 8,5 | 10 | 14,25 \$ |
| IRTU-6521 | CAL-M400 | 400 | 40 | 26,2 | 163 | 93 | 105 | 35 | 29,0 | 12,5 | 10,5 | 10 | 16,20 |
| IRTU-6522 | CAL-M500 | 500 | 40 | 29 | 163 | 93 | 105 | 35 | 29,0 | 12,5 | 10,5 | 10 | 16,20 \$ |

Alüminyum-Bakır Ek Muf / Aluminium Copper Butt Connectors

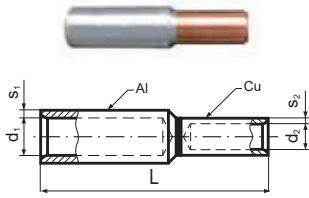

| Kod / Code | AL KABLO KESİTİ | CU KABLO KESİTİ | d1 | d2 | L | v | K. Ad. |
|------------|---------------------|---------------------|------|------|-------|----------|--------|
| IRTU-6351 | 35 mm ² | 16 mm ² | 8,5 | 7,0 | 85,0 | 2,00 \$ | 90 |
| IRTU-6352 | 50 mm ² | 25 mm ² | 9,8 | 8,5 | 90,0 | 2,50 \$ | 80 |
| IRTU-6353 | 70 mm ² | 35 mm ² | 11,5 | 9,8 | 100,0 | 3,40 \$ | 70 |
| IRTU-6354 | 95 mm ² | 50 mm ² | 13,5 | 11,5 | 110,0 | 5,00 \$ | 42 |
| IRTU-6355 | 120 mm ² | 70 mm ² | 15,0 | 13,5 | 110,0 | 5,60 \$ | 35 |
| IRTU-6356 | 150 mm ² | 95 mm ² | 16,5 | 15,0 | 115,0 | 6,70 \$ | 30 |
| IRTU-6357 | 185 mm ² | 120 mm ² | 18,5 | 16,5 | 125,0 | 8,60 \$ | 24 |
| IRTU-6358 | 240 mm ² | 150 mm ² | 21,0 | 18,5 | 130,0 | 13,20 \$ | 16 |

Alüminyum-Bakır Ek Muf / Aluminium Copper Butt Connectors (Pins)

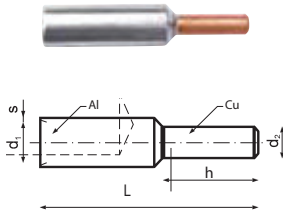

| Kod / Code | K. Kesiti | | d1 | d2 | L | h | K. Ad. | Ad. / \$ |
|------------|-----------------|-----------------|------|----|-----|----|--------|----------|
| | Çok Tellî Kablo | Tek Damar Kablo | | | | | | |
| IRTU-6333 | 10 | 16 | 12 | 5 | 58 | 15 | 100 | 2,20 \$ |
| IRTU-6334 | 16 | 25 | 12 | 6 | 58 | 15 | 100 | 2,20 \$ |
| IRTU-6335 | 25 | 35 | 6.8 | 6 | 58 | 20 | 50 | 2,30 \$ |
| IRTU-6336 | 35 | 50 | 8.0 | 7 | 71 | 22 | 50 | 2,50 \$ |
| IRTU-6337 | 50 | 70 | 9.8 | 8 | 74 | 25 | 80 | 3,00 \$ |
| IRTU-6338 | 70 | 95 | 11.2 | 10 | 87 | 30 | 70 | 3,30 \$ |
| IRTU-6339 | 95 | 120 | 13.2 | 12 | 91 | 33 | 48 | 4,60 \$ |
| IRTU-6340 | 120 | 150 | 14.7 | 12 | 97 | 38 | 35 | 5,50 \$ |
| IRTU-6341 | 150 | 185 | 16.3 | 12 | 108 | 38 | 30 | 5,70 \$ |
| IRTU-6342 | 185 | 240 | 18.3 | 14 | 116 | 44 | 24 | 7,50 \$ |
| IRTU-6343 | 240 | 300 | 21.0 | 16 | 128 | 44 | 16 | 8,40 |
| IRTU-6344 | 300 | - | 23.3 | 18 | 131 | 46 | 9 | 10,00 \$ |

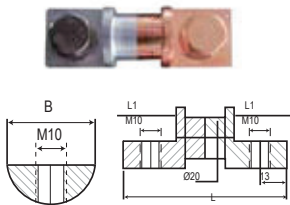

KJB Tip Metalik Alüminyum-Bakır Bağlantı Elemanı / KJB Type Bimetal (Al-Cu)

| Kod / Code | Ref. No | L (mm) | L1 (mm) | B (mm) | Bolt Diameter | K. Ad. | Ad. / \$ |
|------------|---------|--------|---------|--------|---------------|--------|----------|
| IRTU-6530 | KJB-26 | 80 | 26 | 26 | M 10 | 24 | 16,00 \$ |
| IRTU-6531 | KJB-29 | 80 | 26 | 29 | M 10 | 24 | 18,00 \$ |

DELİKLİ KABLO KANALLARI

- Yüksek darbeye dayanıklı sert PVC malzeme
- -15 °C + 70 °C arası sıcaklık dayanımı
- UL94 V0 yanmazlık standardı
- Kolay kapanabilen kapak sistemi
- Yan tırnaklardaki kesikler sayesinde kolay kırılabilme imkanı
- 2 m standart boy
- 390 kg/cm gerilme gücü
- Renk RAL 7030 (Gri)

Pano İçi Delikli Kablo Kanalı / Panel Internal Slotted Cable Trunking

| Ölçü / Size | Ambalaj Miktarı / Packing Qty. (mt) | Kod / Code | B. Fiyat / Unit Price (₺/mt) | Kod / Code | Halojen Free B. Fiyat / Unit Price (₺/mt) |
|-------------|-------------------------------------|--------------|------------------------------|--------------|---|
| 25x30 mm | 84 | IRTU-KN02530 | | IRTU-KN22530 | |
| 25x40 mm | 84 | IRTU-KN02540 | | IRTU-KN22540 | |
| 25x60 mm | 48 | IRTU-KN02560 | | IRTU-KN22560 | |
| 40x40 mm | 60 | IRTU-KN04040 | | IRTU-KN24040 | |
| 40x60 mm | 36 | IRTU-KN04060 | | IRTU-KN24060 | |
| 40x80 mm | 40 | IRTU-KN04080 | | IRTU-KN24080 | |
| 60x40 mm | 36 | IRTU-KN06040 | | IRTU-KN26040 | |
| 60x60 mm | 24 | IRTU-KN06060 | | IRTU-KN26060 | |
| 60x80 mm | 24 | IRTU-KN06080 | | IRTU-KN26080 | |
| 80x60 mm | 24 | IRTU-KN08060 | | IRTU-KN28060 | |
| 80x80 mm | 24 | IRTU-KN08080 | | IRTU-KN28080 | |
| 100x60 mm | 24 | IRTU-KN10060 | | IRTU-KN20060 | |



Delikli Kablo Kanalı Kapakları / Slotted Cable Trunking Cover

| Ölçü / Size | Ambalaj Miktarı / Packing Qty. (mt) | Kod / Code | B. Fiyat / Unit Price (₺/mt) | Kod / Code | Halojen Free B. Fiyat / Unit Price (₺/mt) |
|-------------|-------------------------------------|-------------|------------------------------|-------------|---|
| 25 mm | 140 | IRTU-KN5001 | | IRTU-KN6001 | |
| 40 mm | 80 | IRTU-KN5002 | | IRTU-KN6002 | |
| 60 mm | 50 | IRTU-KN5003 | | IRTU-KN6003 | |
| 80 mm | 50 | IRTU-KN5004 | | IRTU-KN6004 | |
| 100 mm | 40 | IRTU-KN5005 | | IRTU-KN6005 | |

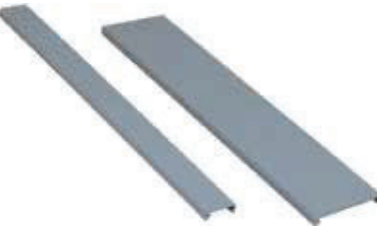

KABLO TOPLAMA ÇORAPLARI

- Malzeme : Pet (Polyester)
- Çalışma Sıcaklığı : -50°C -- +150°C
- Dayanım Üst Noktası : 220 °C
- Erime Noktası : +250 °C

TS EN 60695-2-11 Standardı ve Belgesi.

960°C

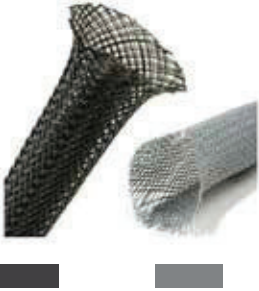

| Kod / Code | Renk / Color | Ölçüler / Dimensions | Ambalaj Miktarı / Spool (mt) | Birim Fiyat / Unit Price (mt/euro) |
|------------|-----------------------------|----------------------|------------------------------|------------------------------------|
| IRTU-PKC03 | Siyah / Black Gri / Grey | 3 X 9 mm | 100 | 0,264 \$ |
| IRTU-PKC06 | Siyah / Black Gri / Grey | 6 x 11 mm | 100 | 0,319 \$ |
| IRTU-PKC08 | Siyah / Black Gri / Grey | 7 x 11 mm | 100 | 0,330 \$ |
| IRTU-PKC10 | Siyah / Black Gri / Grey | 10 x 17 mm | 100 | 0,396 \$ |
| IRTU-PKC12 | Siyah / Black Gri / Grey | 12 x 21 mm | 100 | 0,473 \$ |
| IRTU-PKC15 | Siyah / Black Gri / Grey | 15 x 24 mm | 100 | 0,528 \$ |
| IRTU-PKC20 | Siyah / Black Gri / Grey | 20 x 28 mm | 100 | 0,616 \$ |
| IRTU-PKC25 | Siyah / Black Gri / Grey | 25 x 36 mm | 100 | 0,792 \$ |
| IRTU-PKC30 | Siyah / Black Gri / Grey | 30 x 43 mm | 50 | 0,957 \$ |
| IRTU-PKC40 | Siyah / Black Gri / Grey | 40 x 60 mm | 50 | 1,254 \$ |
| IRTU-PKC50 | Siyah / Black Gri / Gray | 50 x 75 mm | 25 | 1,540 \$ |

Halogen free, alev yaymaz / Halogen free, Non Flame Propagating

Polyefin, Halojen free, 2/1 Oranında Daralan RoHS ISO UL Sertifikalı
Polyefin, Halogen free, 2/1 Ratio Shrinkage RoHS ISO UL Certified

| Kod / Code | Ölçü / Size | | Daralmadan Önce Before Contraction (mm) | | Daraldıktan Sonra After Contraction (mm) | | Ambalaj Miktarı Spool (m) | Birim Fiyat Unite Price (adet/Pcs) |
|----------------|-------------|------|--|-----------------------------------|---|-----------------------------------|---------------------------------|--|
| | İnc(Ø) | mm. | İç Çap Inside Diameter | Cidar Kalınlığı Wall Thickness | İç Çap Inside Diameter | Cidar Kalınlığı Wall Thickness | | |
| IRTU-IDMS00015 | | 1,5 | 2,0±0,2 | 0,18±0,05 | 0,85 | 0,32±0,10 | 200 | 0,131 \$ |
| IRTU-IDMS00020 | | 2 | 2,5±0,2 | 0,18±0,05 | 0,60 | 0,28±0,10 | 200 | 0,155 \$ |
| IRTU-IDMS00024 | 3/32 | 2,4 | 3,0±0,3 | 0,18±0,05 | 1,2 | 0,35±0,10 | 200 | 0,155 \$ |
| IRTU-IDMS00025 | | 2,5 | 3,0±0,2 | 0,18±0,05 | 1,30 | 0,38±0,10 | 200 | 0,203 \$ |
| IRTU-IDMS00030 | | 3 | 3,5±0,2 | 0,18±0,05 | 1,50 | 0,40±0,10 | 200 | 0,216 \$ |
| IRTU-IDMS00032 | 1/8 | 3,2 | 3,5±0,4 | 0,18±0,05 | 1,6 | 0,40±0,10 | 200 | 0,216 \$ |
| IRTU-IDMS00035 | | 3,5 | 4,0±0,2 | 0,22±0,05 | 1,80 | 0,42±0,10 | 200 | 0,230 \$ |
| IRTU-IDMS00040 | | 4 | 4,5±0,2 | 0,25±0,05 | 2,00 | 0,45±0,10 | 100 | 0,270 \$ |
| IRTU-IDMS00045 | | 4,5 | 5,0±0,2 | 0,25±0,05 | 2,30 | 0,50±0,10 | 100 | 0,311 \$ |
| IRTU-IDMS00048 | 3/16 | 4,8 | 5,2±0,4 | 0,25±0,05 | 2,4 | 0,50±0,10 | 100 | 0,311 \$ |
| IRTU-IDMS00050 | | 5 | 5,5±0,2 | 0,25±0,05 | 2,50 | 0,55±0,10 | 100 | 0,338 \$ |
| IRTU-IDMS00060 | | 6 | 6,5±0,2 | 0,28±0,05 | 3,00 | 0,55±0,10 | 100 | 0,392 \$ |
| IRTU-IDMS00064 | 1/4 | 6,4 | 7,0±0,4 | 0,28±0,05 | 3,2 | 0,55±0,10 | 100 | 0,392 \$ |
| IRTU-IDMS00070 | | 7 | 7,5±0,3 | 0,28±0,05 | 3,50 | 0,55±0,10 | 100 | 0,473 \$ |
| IRTU-IDMS00080 | | 8 | 8,5±0,3 | 0,28±0,05 | 4,00 | 0,60±0,10 | 100 | 0,473 \$ |
| IRTU-IDMS00090 | | 9 | 9,5±0,3 | 0,30±0,08 | 4,50 | 0,60±0,10 | 100 | 0,473 \$ |
| IRTU-IDMS00095 | 3/8 | 9,5 | 10,0±0,5 | 0,30±0,08 | 4,8 | 0,60±0,10 | 100 | 0,473 \$ |
| IRTU-IDMS00100 | | 10 | 10,5±0,3 | 0,30±0,08 | 5,00 | 0,60±0,10 | 100 | 0,527 \$ |
| IRTU-IDMS00110 | | 11 | 11,5±0,3 | 0,30±0,08 | 5,50 | 0,60±0,10 | 100 | 0,527 \$ |
| IRTU-IDMS00120 | | 12 | 12,5±0,3 | 0,30±0,08 | 6,00 | 0,60±0,10 | 100 | 0,527 \$ |
| IRTU-IDMS00127 | 1/2 | 12,7 | 13,0±0,5 | 0,30±0,08 | 6,4 | 0,60±0,10 | 100 | 0,608 \$ |
| IRTU-IDMS00130 | | 13 | 13,5±0,3 | 0,35±0,10 | 6,50 | 0,65±0,10 | 100 | 0,648 \$ |
| IRTU-IDMS00140 | | 14 | 14,5±0,3 | 0,35±0,10 | 7,00 | 0,65±0,10 | 100 | 0,756 \$ |
| IRTU-IDMS00150 | | 15 | 15,5±0,3 | 0,35±0,10 | 7,00 | 0,65±0,10 | 100 | 0,756 \$ |
| IRTU-IDMS00160 | | 16 | 16,5±0,4 | 0,40±0,12 | 8,00 | 0,70±0,10 | 100 | 1,013 \$ |
| IRTU-IDMS00170 | | 17 | 17,5±0,4 | 0,40±0,12 | 8,50 | 0,70±0,10 | 100 | 1,013 \$ |
| IRTU-IDMS00180 | | 18 | 19,0±0,5 | 0,40±0,15 | 9,00 | 0,80±0,15 | 100 | 1,323 \$ |
| IRTU-IDMS00191 | 3/4 | 19,1 | 20,5±0,6 | 0,40±0,15 | 9,5 | 0,80±0,15 | 100 | 1,323 \$ |
| IRTU-IDMS00200 | 4/5 | 20 | 21,0±0,6 | 0,40±0,15 | 10,00 | 0,80±0,15 | 100 | 1,688 \$ |
| IRTU-IDMS00220 | | 22 | 23,0±0,6 | 0,40±0,15 | 11,00 | 0,80±0,15 | 100 | 2,093 \$ |
| IRTU-IDMS00254 | 1 | 25,4 | 25,6±0,7 | 0,50±0,15 | 12,70 | 0,90±0,15 | 50 | 2,228 \$ |
| IRTU-IDMS00300 | | 30 | 31,5±1,0 | 0,50±0,15 | 15,00 | 0,90±0,15 | 50 | 2,903 \$ |
| IRTU-IDMS00302 | 1 1/4 | 32 | 33,0±0,7 | 0,50±0,15 | 15,9 | 0,95±0,15 | 50 | 2,903 \$ |
| IRTU-IDMS00350 | | 35 | 36,5±1,0 | 0,50±0,15 | 17,50 | 0,95±0,15 | 50 | 3,645 \$ |
| IRTU-IDMS00380 | 1 1/2 | 38 | 40,0±0,7 | 0,50±0,15 | 19,1 | 1,00±0,15 | 50 | 4,050 \$ |
| IRTU-IDMS00400 | | 40 | 41,5±1,0 | 0,55±0,15 | 20,00 | 1,00±0,15 | 50 | 4,050 \$ |
| IRTU-IDMS00510 | 2 | 51 | 52,5±0,7 | 0,55±0,15 | 25,4 | 0,95±0,15 | 25 | 5,130 \$ |
| IRTU-IDMS00600 | | 60 | 60,00 | 0,60±0,15 | 30,00 | 1,30±0,20 | 25 | 6,885 \$ |
| IRTU-IDMS00700 | | 70 | 70,00 | 0,65±0,15 | 35,00 | 1,30±0,20 | 25 | 9,180 \$ |
| IRTU-IDMS00760 | 3 | 76 | 80,0±1,0 | 0,65±0,15 | 38,1 | 1,30±0,20 | 25 | 9,180 \$ |
| IRTU-IDMS00800 | | 80 | 80,00 | 0,65±0,15 | 40,00 | 1,46±0,20 | 25 | 10,125 \$ |
| IRTU-IDMS00900 | | 90 | 90,00 | 0,65±0,15 | 45,00 | 1,46±0,20 | 25 | 11,475 \$ |
| IRTU-IDMS00960 | | 96 | 100 | 0,65±0,15 | 50 | 1,46±0,20 | 25 | 11,475 \$ |
| IRTU-IDMS01020 | 4 | 102 | 105±1,0 | 0,65±0,20 | 50,80 | 1,46±0,20 | 25 | 12,825 \$ |
| IRTU-IDMS01200 | 5 | 120 | 120,00 | 0,65±0,20 | 63,50 | 1,56±0,20 | 20 | 17,550 \$ |
| IRTU-IDMS01500 | | 150 | 150,00 | 0,65±0,20 | 75,00 | 1,56±0,20 | 25 | 25,650 \$ |
| IRTU-IDMS01800 | | 180 | 180,00 | 0,65±0,20 | 90,00 | 1,56±0,20 | 25 | 36,450 \$ |



2/1 Isı ile Daralan Makaron (şeffaf, beyaz, kırmızı, gri, mavi, sarı-yeşil)
2/1 Rate Heat Shrink (transparent, white, red, grey, blue, yellow-green)

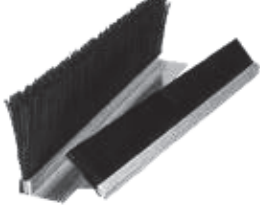

| Kod / Code | Ölçü / Size | | Ambalaj Miktarı Spool (mt) | Birim Fiyat Unit Price (mt / usd) | Kahverengi Brown (mt / usd) | Sarı-Yeşil Yellow-Green (mt / usd) |
|---------------|-------------|------|----------------------------|-----------------------------------|-----------------------------|------------------------------------|
| | Inch | mm | | | | |
| IRTU-IDM00016 | 1/16 | 1,6 | 200 | 0.149 \$ | 0.162 \$ | |
| IRTU-IDM00020 | | 2 | 200 | | | |
| IRTU-IDM00024 | 3/32 | 2,4 | 200 | | | |
| IRTU-IDM00025 | | 2,5 | 200 | 0.230 \$ | 0.243 \$ | 0,567 \$ |
| IRTU-IDM00032 | 1/8 | 3,2 | 200 | 0.270 \$ | 0,297 \$ | 0,581 \$ |
| IRTU-IDM00035 | | 3,5 | 200 | 0.284 \$ | | |
| IRTU-IDM00048 | 3/16 | 4,8 | 100 | 0.365 \$ | 0.392 \$ | 0,594 \$ |
| IRTU-IDM00050 | | 5 | 100 | | | |
| IRTU-IDM00064 | 1/4 | 6,4 | 100 | 0.446 \$ | 0,513 \$ | 0,675 \$ |
| IRTU-IDM00070 | | 7 | 100 | 0.446 \$ | 0,513 \$ | |
| IRTU-IDM00095 | 3/8 | 9,5 | 100 | 0.527 \$ | 0,594 \$ | 0,918 \$ |
| IRTU-IDM00100 | | 10 | 100 | | | |
| IRTU-IDM00120 | | 12 | 100 | | | |
| IRTU-IDM00127 | 1/2 | 12,7 | 100 | 0.743 \$ | 0,810 \$ | 1,350 \$ |
| IRTU-IDM00160 | | 16 | 100 | 1.148 \$ | 1,418 \$ | 1,958 \$ |
| IRTU-IDM00191 | 3/4 | 19,1 | 100 | 2.025 \$ | 2,093 \$ | 2,565 \$ |
| IRTU-IDM00200 | 4/5 | 20 | 100 | 2.025 \$ | 2,093 \$ | 2,565 \$ |
| IRTU-IDM00254 | 1 | 25,4 | 50 | 2.565 \$ | 2,835 \$ | 3,713 \$ |
| IRTU-IDM00320 | 1 1/4 | 32 | 50 | 3.240 \$ | 3,780 \$ | 4,995 \$ |
| IRTU-IDM00350 | | 35 | 50 | | | |
| IRTU-IDM00380 | 1 1/2 | 38 | 50 | 4.860 \$ | 5,535 \$ | 6,750 \$ |
| IRTU-IDM00510 | 2 | 51 | 50 | 5.670 \$ | 6,615 \$ | \$ |
| IRTU-IDM00600 | | 60 | 25 | 7.830 \$ | 10,125 \$ | 14,500 \$ |
| IRTU-IDM00700 | | 70 | 25 | | | |
| IRTU-IDM00760 | 3 | 76 | 25 | 10.800 \$ | 12,150 \$ | 21,750 \$ |
| IRTU-IDM00960 | | 96 | 25 | | | |
| IRTU-IDM01020 | 4 | 102 | 25 | 14.850 \$ | 18,225 \$ | 33,350 \$ |
| IRTU-IDM01200 | 5 | 120 | 25 | | | |
| IRTU-IDM01500 | | 150 | 25 | | | |
| IRTU-IDM01800 | | 180 | 25 | | | |

Alüminyum Pano Fırçası / Aluminium

960°C
KIZARAN
TEL TESTİ

| Kod / Code | Ürün Tanımı / Product Name | Kıl Boyu / Bristle Length | Uzunluk / Length (mt) | Kutu Ad. / Box Qty | Birim Fiyat Unit Price (Metre) |
|---------------|--|---------------------------|-----------------------|--------------------|--------------------------------|
| IRTU-FRA20030 | ALÜMİNYUM PANO TOZ FIRÇASI / POWDER BRUSH ALUMINIUM PANELS | 30 | 2 | 30 | 185,65 TL |
| IRTU-FRA20040 | ALÜMİNYUM PANO TOZ FIRÇASI / POWDER BRUSH ALUMINIUM PANELS | 40 | 2 | 30 | 190,10 TL |
| IRTU-FRA20050 | ALÜMİNYUM PANO TOZ FIRÇASI / POWDER BRUSH ALUMINIUM PANELS | 50 | 2 | 100 | 194,50 TL |
| IRTU-FRA20060 | ALÜMİNYUM PANO TOZ FIRÇASI / POWDER BRUSH ALUMINIUM PANELS | 60 | 2 | 30 | 238,70 TL |
| IRTU-FRA20070 | ALÜMİNYUM PANO TOZ FIRÇASI / POWDER BRUSH ALUMINIUM PANELS | 70 | 2 | 30 | 278,50 TL |
| IRTU-FRA20080 | ALÜMİNYUM PANO TOZ FIRÇASI / POWDER BRUSH ALUMINIUM PANELS | 80 | 2 | 30 | 300,60 TL |
| IRTU-FRA20100 | ALÜMİNYUM PANO TOZ FIRÇASI / POWDER BRUSH ALUMINIUM PANELS | 100 | 2 | 30 | 335,90 TL |
| IRTU-FRA20150 | ALÜMİNYUM PANO TOZ FIRÇASI / POWDER BRUSH ALUMINIUM PANELS | 150 | 2 | 30 | 663,00 TL |

TS EN 60695-2-11 Standardı ve Belgesi.
Plastik Pano Fırçası / Plastic Panel Brush

960°C
KIZARAN
TEL TESTİ

| Kod / Code | Ürün Tanımı / Product Name | Kıl Boyu / Bristle Length | Uzunluk / Length (mt) | Kutu Ad. / Box Qty | Birim Fiyat Unit Price (Metre) |
|---------------|--|---------------------------|-----------------------|--------------------|--------------------------------|
| IRTU-FRP20030 | PLASTİK GEÇME PANO FIRÇASI / PLASTIC PROMOTION BOARD BRUSH | 30 | 2 | 30 | 234,30 TL |
| IRTU-FRP20040 | PLASTİK GEÇME PANO FIRÇASI / PLASTIC PROMOTION BOARD BRUSH | 40 | 2 | 30 | 243,10 TL |
| IRTU-FRP20050 | PLASTİK GEÇME PANO FIRÇASI / PLASTIC PROMOTION BOARD BRUSH | 50 | 2 | 100 | 273,00 TL |
| IRTU-FRP20060 | PLASTİK GEÇME PANO FIRÇASI / PLASTIC PROMOTION BOARD BRUSH | 60 | 2 | 30 | 296,20 TL |
| IRTU-FRP20070 | PLASTİK GEÇME PANO FIRÇASI / PLASTIC PROMOTION BOARD BRUSH | 70 | 2 | 30 | 313,80 TL |
| IRTU-FRP20080 | PLASTİK GEÇME PANO FIRÇASI / PLASTIC PROMOTION BOARD BRUSH | 80 | 2 | 30 | 331,50 TL |
| IRTU-FRP20100 | PLASTİK GEÇME PANO FIRÇASI / PLASTIC PROMOTION BOARD BRUSH | 100 | 2 | 100 | 397,80 TL |
| IRTU-FRP22050 | PLASTİK RULO PANO FIRÇASI (25 Mt) / PLASTIC ROLL BOARD BRUSH (25 Mt) | 50 | 25 | 25 | 530,40 TL |

TS EN 60695-2-11 Standardı ve Belgesi.
Pano Kenar Fitili / U Panel Tape

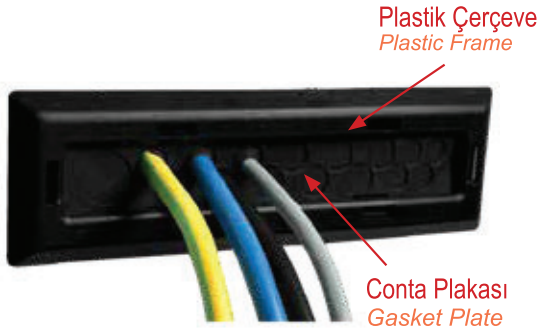

| Kod / Code | Ürün Tanımı / Product Name | Kutu Adedi Box Qty | Birim Fiyat Unit Price (tkm/set) |
|----------------|--|--------------------|----------------------------------|
| IRTU-FTL1004/S | U Siyah Sac Kenar Fitili (0,80 mm-1,5 mm) U Black Panel Tape (0,80 mm-1,5 mm) | 300 | 24,50 TL |
| IRTU-FTL1004/G | U Gri Sac Kenar Fitili (0,80 mm-1,5 mm) U Gray Panel Tape (0,80 mm-1,5 mm) | 300 | 24,50 TL |
| IRTU-FTL1006/S | U Siyah Sac Kenar Fitili (2 mm-2,5 mm) U Black Panel Tape (2 mm-2,5 mm) | 300 | 35,00 TL |
| IRTU-FTL1006/G | U Gri Sac Kenar Fitili - (2 mm-2,5 mm) U Gray Panel Tape (2 mm-2,5 mm) | 300 | 35,00 TL |



Kablo giriş plakaları, soketsiz kablo geçişleri için kullanılır. Kabloların geçişleri için 'conta plakası'na ufak bir delik açılması yeterlidir. Kompakt ve ince formu sayesinde sızdırmazlık özellikli kablo geçişleri sunar. Özellikle dar alanlarda çok sayıda kablunun geçişi için uygundur.

Cable entry plates are used for cable without sockets. The product provides a sealed cable feed-through thanks to its compact and slim design. Thanks to its compact and slim form, it offers leak-proof cable passages. The feature of the product is that it is suitable for the passage of a large number of cables in tight spaces.

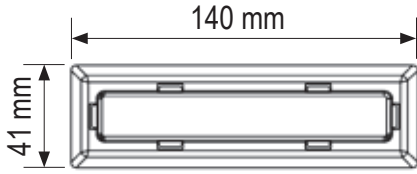
Kablo Geçiş Plakası (140 - 41 mm) / Cable Input Plate



Plastik Çerçeve / Plastic Frame

| Ürün Kodu Code | Ürün Tanımı Product Name | Ölçüler Dimensions | Kutu Adet Box Qty | Birim Fiyat Unit Price |
|-------------------|-----------------------------|-----------------------|----------------------|---------------------------|
| IRTU-KGC41140 | Plastik Çerçeve | 41 x 140mm | 25 | 86,20 TL |

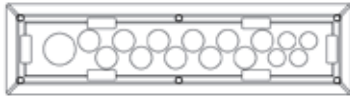

Conta Plakası / Gasket Plate

| Ürün Kodu Code | Ürün Tanımı Product Name | Ölçüler Dimensions | Kablo Geçiş Ölçüleri Cable Passage Dimensions | Kutu Adet Box Qty | Birim Fiyat Unit Price |
|-------------------|-------------------------------|-----------------------|--|----------------------|---------------------------|
| IRTU-KCP0010 | Conta Plakası Gasket Plate | 35 x 133 mm | 16 x Ø6.5mm 4 x Ø8.5mm 1 x Ø12mm | 25 | 78,50 TL |
| IRTU-KCP0011 | Conta Plakası Gasket Plate | 35 x 133 mm | 4 x Ø6.5mm 11 x Ø8.5mm 1 x Ø12mm | 25 | 78,50 TL |

Kablo Geçiş Plakası (220 - 74 mm) / Cable Input Plate

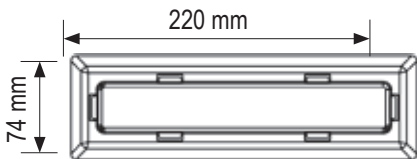

Plastik Çerçeve / Plastic Frame

| Ürün Kodu Code | Ürün Tanımı Product Name | Ölçüler Dimensions | Kutu Adet Box Qty | Birim Fiyat Unit Price |
|-------------------|-----------------------------|-----------------------|----------------------|---------------------------|
| IRTU-KGC74220 | Plastik Çerçeve | 74 x 220mm | 25 | 145,00 TL |

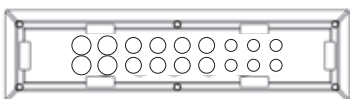

Conta Plakası / Gasket Plate

| Ürün Kodu Code | Ürün Tanımı Product Name | Ölçüler Dimensions | Kablo Geçiş Ölçüleri Cable Passage Dimensions | Kutu Adet Box Qty | Birim Fiyat Unit Price |
|-------------------|-------------------------------|-----------------------|--|----------------------|---------------------------|
| IRTU-KCP0022 | Conta Plakası Gasket Plate | 65 x 210 mm | 6 x Ø10,5mm 8 x Ø13,5mm 4 x Ø16mm | 25 | 145,00 TL |

Standart Kablo Bağları / Standart Cable Ties

| Kod / Code | Renk / Color | Kod 2 / Code 2 | Renk / Color | L | W | Max. Bağlama Çapı / Max. Connecting Size | Taşıyıcı Ağırlık / Carrying Weight (kg) | Poşet Adedi/ Bag Qty | Koli Adedi/ Box Qty. | Birim Fiyat Unit Price (Adet/pcs) |
|---------------|--------------|----------------|--------------|-----|-----|--|---|----------------------|----------------------|-----------------------------------|
| IRTU-KBS10025 | ■ | IRTU-KBB10025 | □ | 100 | 2,5 | 22 | 8,1 | 100/1000 | 70.000 | 0,393 TL |
| IRTU-KBS15025 | ■ | IRTU-KBB15025 | □ | 150 | | 33 | | 100/1000 | 55.000 | 0,571 TL |
| IRTU-KBS20025 | ■ | IRTU-KBB20025 | □ | 200 | | 53 | | 100/100 | 45.000 | 0,834 TL |
| IRTU-KBS15036 | ■ | IRTU-KBB15036 | □ | 150 | 3,6 | 35 | 18,2 | 100/100 | 33.000 | 0,964 TL |
| IRTU-KBS20036 | ■ | IRTU-KBB20036 | □ | 200 | | 53 | | 100/100 | 25.000 | 1,273 TL |
| IRTU-KBS25036 | ■ | IRTU-KBB25036 | □ | 250 | | 65 | | 100/100 | 20.000 | 1,547 TL |
| IRTU-KBS30036 | ■ | IRTU-KBB30036 | □ | 300 | 4,8 | 76 | 22,2 | 100/100 | 20.000 | 1,904 TL |
| IRTU-KBS37036 | ■ | IRTU-KBB37036 | □ | 370 | | 102 | | 100/100 | 15.000 | 2,380 TL |
| IRTU-KBS20048 | ■ | IRTU-KBB20048 | □ | 200 | | 50 | | 100 | 16.000 | 1,785 TL |
| IRTU-KBS25048 | ■ | IRTU-KBB25048 | □ | 250 | 7,6 | 60 | 54,5 | 100 | 13.000 | 2,202 TL |
| IRTU-KBS30048 | ■ | IRTU-KBB30048 | □ | 300 | | 76 | | 100 | 13.000 | 2,737 TL |
| IRTU-KBS37048 | ■ | IRTU-KBB37048 | □ | 370 | | 102 | | 100 | 10.000 | 3,094 TL |
| IRTU-KBS43048 | ■ | IRTU-KBB43048 | □ | 430 | 9 | 110 | 79,4 | 100 | 9.000 | 4,165 TL |
| IRTU-KBS30076 | ■ | IRTU-KBB30076 | □ | 300 | | 76 | | 100 | 6.500 | 5,712 TL |
| IRTU-KBS37076 | ■ | IRTU-KBB37076 | □ | 370 | | 102 | | 100 | 5.000 | 6,069 TL |
| IRTU-KBS43076 | ■ | IRTU-KBB43076 | □ | 450 | 9 | 127 | 79,4 | 100 | 3.500 | 6,545 TL |
| IRTU-KBS53076 | ■ | IRTU-KBB53076 | □ | 530 | | 140 | | 100 | 3.000 | 9,163 TL |
| IRTU-KBS71076 | ■ | IRTU-KBB71076 | □ | 710 | | 190 | | 100 | 2.000 | 17,850 TL |
| IRTU-KBS76090 | ■ | IRTU-KBB76090 | □ | 760 | 9 | 236 | 79,4 | 100 | 2.000 | 19,635 TL |
| IRTU-KBS94090 | ■ | IRTU-KBB94090 | □ | 940 | | 280 | | 100 | 1.000 | 22,610 TL |

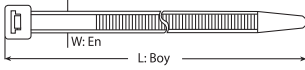

Etiketli Kablo Bağları / Cable Tie Labels

| Kod / Code | L | W | Max. Bağlama Çapı / Max. Connecting Size | Taşıyıcı Ağırlık / Carrying Weight (kg) | Poşet Adedi/ Bag Qty | Birim Fiyat Unit Price 316 (Adet/pcs) |
|---------------|-----|-----|--|---|----------------------|---------------------------------------|
| IRTU-EKB10025 | 100 | 2,5 | 20 | 8,1 | 100 | 1,430 TL |
| IRTU-EKB19025 | 190 | 4,8 | 48 | 22,2 | 100 | 3,340 TL |



Metal Kablo Bağları / Stainless Steel Cable Ties



| Kod / Code | L | W | Max. Bağlama Çapı / Max. Connecting Size | Taşıyıcı Ağırlık / Carrying Weight (kg) | Poşet Adedi/ Bag Qty | Birim Fiyat Unit Price 304 (Adet/pcs) |
|------------------|-----|-----|---|--|-------------------------|---|
| IRTU-MTL30415246 | 150 | 4,6 | 37 | 55 | 100 | 5,959 TL |
| IRTU-MTL30420146 | 200 | | 50 | | 100 | 6,660 TL |
| IRTU-MTL30426646 | 260 | | 69 | | 100 | 7,735 TL |
| IRTU-MTL30430046 | 300 | | 76 | | 100 | 8,095 TL |
| IRTU-MTL30436246 | 370 | | 102 | | 100 | 8,925 TL |
| IRTU-MTL30452146 | 520 | | 152 | | 100 | 11,300 TL |
| IRTU-MTL30467946 | 680 | | 203 | | 100 | 13,685 TL |
| IRTU-MTL30483846 | 840 | | 254 | | 100 | 16,660 TL |
| IRTU-MTL30420179 | 200 | 7,9 | 50 | 120 | 100 | 10,710 TL |
| IRTU-MTL30430079 | 300 | | 76 | | 100 | 12,500 TL |
| IRTU-MTL30436279 | 370 | | 102 | | 100 | 14,875 TL |
| IRTU-MTL30452179 | 520 | | 152 | | 100 | 17,850 TL |
| IRTU-MTL30467979 | 680 | | 203 | | 100 | 21,420 TL |
| IRTU-MTL30483879 | 840 | | 254 | | 100 | 26,180 TL |

Yapışkan Kroşeler / Sticky Crochets

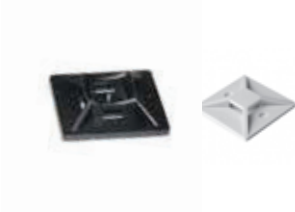

| Kod / Code | A | B | C | D | H | Poşet Adedi/ Bag Qty | Birim Fiyat Unit Price (Adet/pcs) |
|--------------|----|-----|----|------|-----|-------------------------|---|
| IRTU-YKR1919 | 19 | 3,6 | 19 | Ø3,2 | 4 | 100 | 2,160 TL |
| IRTU-YKR2727 | 28 | 4,8 | 28 | | 4,5 | 100 | 3,900 TL |

Vidalı Kroşe / Screw-in Cable Clamp



| Kod / Code | A | B | C | D | E | Max. Sıkma Çapı / Max. Connecting Size | Renk / Color | Poşet Adedi/ Bag Qty | Birim Fiyat Unit Price (Adet/pcs) |
|---------------|------|------|-----|-----|------|---|-----------------|-------------------------|---|
| IRTU-VK149950 | 14,9 | 9,5 | 6,9 | 4,5 | 7,8 | 4,8 | Beyaz / White | 100 | 1,620 TL |
| IRTU-VK222159 | 22,2 | 15,9 | 9,7 | 6,4 | 12,6 | 7,6 | Beyaz / White | 100 | 2,340 TL |

Pano İçi Montaj Rayı / Panel Mounting Rail



| Kod / Code | Ölçü / Size (mm) | Ürün Tanımı / Product name | Tip / Type | Uzunluk Lenght (mt/mt) | Paket Miktarı Box Qty (mt) | Birim Fiyat Unit Price (mt) |
|--------------|------------------|-----------------------------|-------------------------|------------------------|----------------------------|-----------------------------|
| IRTU-MR3010 | 35x7,5x1 | Krom 3 (Cr+3)Coated Crom +3 | Delikli / Perforated | 2 | 50 | |
| IRTU-MR3011 | 35x7,5x1 | Krom 3 (Cr+3)Coated Crom +3 | Deliksiz / Imperforated | 2 | 50 | |
| IRTU-MR4010 | 35x7,5x1 | Galvaniz | Delikli / Perforated | 2 | 50 | |
| IRTU-MR4011 | 35x7,5x1 | Galvaniz | Deliksiz / Imperforated | 2 | 50 | |
| IRTU-MR4010E | 35x7,5x1 | Galvaniz (Eko) | Delikli / Perforated | 2 | 60 | |
| IRTU-MR4011E | 35x7,5x1 | Galvaniz (Eko) | Deliksiz / Imperforated | 2 | 60 | |
| IRTU-MR3012 | 35x15x1,5 | Krom 3 (Cr+3) | Delikli / Perforated | 2 | 40 | |
| IRTU-MR3013 | 35x15x1,5 | Krom 3 (Cr+3) | Deliksiz / Imperforated | 2 | 40 | |
| IRTU-MR4015 | 35x15x1,5 | Galvaniz | Delikli / Perforated | 2 | 40 | |
| IRTU-MR4013 | 35x15x1,5 | Galvaniz | Deliksiz / Imperforated | 2 | 40 | |

Pano İçi MG Tipi Montaj Rayı / MG Type Mounting Rail



| Kod / Code | Tip /Type | Ürün Tanımı / Product Name | Uzunluk Lenght (mt) | Paket Miktarı Box Qty (mt) | Birim Fiyat Unit Price (Adet/pcs) |
|------------|-------------------------|----------------------------|---------------------|----------------------------|-----------------------------------|
| IRTU-4142 | Deliksiz / Imperforated | Alüminyum / Aluminium | 1 | 25 | |
| IRTU-4143 | Deliksiz / Imperforated | Alüminyum / Aluminium | 2 | 25 | |
| IRTU-4147 | Delikli / Perforated | Alüminyum / Aluminium | 1 | 25 | |
| IRTU-4148 | Delikli / Perforated | Alüminyum / Aluminium | 2 | 25 | |

Ray Taşıyıcı / Rail Carrier



| Kod / Code | Ürün Tanımı / Product Name | Tip / Type | Paket Miktarı (mt) | Birim Fiyat Unit Price (Adet/pcs) |
|-------------|-------------------------------|-----------------------------|--------------------|-----------------------------------|
| IRTU-MR1010 | Cr+3 Kaplama / Coated Crom +3 | Ray Taşıyıcı / Rail Carrier | 100 | |
| IRTU-MR1020 | Alüminyum /Aluminium | Ray Taşıyıcı / Rail Carrier | 100 | |
| BC16050 | Ø16x50 mm | Metal Ray Taşıyıcı | 100 | |
| BC16080 | Ø16x80 mm | Metal Ray Taşıyıcı | 100 | |

Silikon Makaronlar (2.5 kV)
Silicon Tubes (2.5 kV)



| Kod / Code | Çap Dia. (mm) | Renkler / Colour | Rulo / Roll (mt) | Birim Fiyat Unit Price (mt / usd) |
|--------------|---------------|-------------------------------|------------------|-----------------------------------|
| FG-SRG-2.00 | 2 | Kırmızı - Siyah / Red - Black | 100 | 0,311 \$ |
| FG-SRG-3.00 | 3 | Kırmızı - Siyah / Red - Black | 100 | 0,486 \$ |
| FG-SRG-4.00 | 4 | Kırmızı - Siyah / Red - Black | 100 | 0,648 \$ |
| FG-SRG-5.00 | 5 | Kırmızı - Siyah / Red - Black | 100 | 0,783 \$ |
| FG-SRG-6.00 | 6 | Kırmızı - Siyah / Red - Black | 100 | 0,959 \$ |
| FG-SRG-7.00 | 7 | Kırmızı - Siyah / Red - Black | 100 | 1,107 \$ |
| FG-SRG-8.00 | 8 | Kırmızı - Siyah / Red - Black | 100 | 1,283 \$ |
| FG-SRG-10.00 | 10 | Kırmızı - Siyah / Red - Black | 100 | 1,755 \$ |
| FG-SRG-12.00 | 12 | Kırmızı - Siyah / Red - Black | 50 | 2,160 \$ |
| FG-SRG-14.00 | 14 | Kırmızı - Siyah / Red - Black | 50 | 2,592 \$ |
| FG-SRG-16.00 | 16 | Kırmızı - Siyah / Red - Black | 50 | 3,483 \$ |
| FG-SRG-18.00 | 18 | Kırmızı - Siyah / Red - Black | 50 | 4,536 \$ |
| FG-SRG-20.00 | 20 | Kırmızı - Siyah / Red - Black | 25 | 5,805 \$ |
| FG-SRG-25.00 | 25 | Kırmızı - Siyah / Red - Black | 25 | 11,070 \$ |

Helezon Kablo Toplama Spiralleri / Helezon Cable Collect Spirals



| Kod / Code | Ürün Tanımı / Product Name | Kablo Kesit (mm ²) Cable Diamete (mm ²) | Ölçüler / Dimensions | | | Ambalaj Miktarı / Spool (mt) | Birim Fiyat Unit Price (mt/euro) |
|------------|----------------------------|---|----------------------|------|------|------------------------------|----------------------------------|
| | | | F | E | L | | |
| IRTU-HR01 | NO: 1 (BOY / SIZE: 10 MT) | 2.5 - 15 | 6 | 0.60 | 7.4 | 10 | 11,70 TL |
| IRTU-HR02 | NO: 2 (BOY / SIZE: 10 MT) | 6 - 30 | 8 | 0.75 | 12.0 | 10 | 14,30 TL |
| IRTU-HR03 | NO: 3 (BOY / SIZE: 10 MT) | 7.5 - 30 | 10 | 0.80 | 12.3 | 10 | 17,55 TL |
| IRTU-HR04 | NO: 4 (BOY / SIZE: 10 MT) | 9 - 32 | 12 | 0.85 | 15.0 | 10 | 22,10 TL |
| IRTU-HR05 | NO: 5 (BOY / SIZE: 10 MT) | 12 - 35 | 15 | 1.00 | 15.5 | 10 | 37,70 TL |

Poliüretan Yapışkanlı Conta / Polyurethane Sticky Gasket



| Kod / Code | Ürün Tanımı / Product Name | Kutu Miktarı Box Qty (mt) | Birim Fiyat Unit Price (tkm/set) |
|--------------|---|---------------------------|----------------------------------|
| IRTU-CNT0510 | 5 x 10 Poliüretan Yapışkanlı Conta / Polyurethane Sticky Gasket | 300 | |
| IRTU-CNT0515 | 5 x 15 Poliüretan Yapışkanlı Conta / Polyurethane Sticky Gasket | 300 | |
| IRTU-CNT0520 | 5 x 20 Poliüretan Yapışkanlı Conta / Polyurethane Sticky Gasket | 300 | |

Plastik Sıra Klemensler, Vida Blokajlı - (Mavi)
Plastic Rear Terminals, Screw Blocked - (Blue)



| Kod / Code | Cinsi / Type | Voltaj / Voltage (V) | Amper / Current (A) | Koli Adedi / Box Qty. | Adet Fiyat Unit Price (Adet/pcs) |
|------------|--|----------------------|---------------------|-----------------------|----------------------------------|
| IRTU-5000 | No. 0 0.75 - 1.5 mm ² lik 12 Sıra/Poles | 400 | 17.5 | 100 | |
| IRTU-5001 | No. 1 2.5 - 4 mm ² lik 12 Sıra/Poles | 400 | 32 | 50 | |
| IRTU-5002 | No. 2 4 - 6 mm ² lik 12 Sıra/Poles | 400 | 41 | 50 | |
| IRTU-5003 | No. 3 6 - 10 mm ² lik 10 Sıra/Poles | 400 | 57 | 50 | |
| IRTU-5004 | No. 4 10 - 16 mm ² lik 6 Sıra/Poles | 500 | 76 | 50 | |
| IRTU-5005 | No. 5 16 - 25 mm ² lik 6 Sıra/Poles | 500 | 101 | 50 | |

Isıya Dayanıklı Plastik, Vida Blokajlı - (Beyaz-Kırmızı) V2, TSE, OSK
Heat-Resistant Plastic, Screw Blocked - (White-Red) V2, TSE, OSK



| Kod / Code | Cinsi / Type | Voltaj / Voltage (V) | Amper Current (A) | Koli Adedi / Box Qty | Adet Fiyat Unit Price (Adet/ pcs) |
|------------|--|----------------------|-------------------|----------------------|-----------------------------------|
| IRTU-5010 | No. 0 0.75 - 1.5 mm ² lik 12 Sıra/Poles | 400 | 17.5 | 100 | |
| IRTU-5011 | No. 1 2.5 - 4 mm ² lik 12 Sıra/Poles | 400 | 32 | 50 | |
| IRTU-5012 | No. 2 4 - 6 mm ² lik 12 Sıra/Poles | 400 | 41 | 50 | |
| IRTU-5013 | No. 3 6 - 10 mm ² lik 10 Sıra/Poles | 400 | 57 | 50 | |
| IRTU-5014 | No. 4 10 - 16 mm ² lik 6 Sıra/Poles | 500 | 76 | 50 | |
| IRTU-5015 | No. 5 16 - 25 mm ² lik 6 Sıra/Poles | 500 | 101 | 50 | |
| IRTU-5016 | No. 3 3'lü 6 - 10 mm ² lik | 400 | 57 | 50 | |

Isıya Dayanıklı Plastik, Vida Blokajlı - (Şeffaf-Polikarbon)
Heat Resistant Plastic, Screw Blocked - (Transparent-Polycarbon)



| Kod / Code | Cinsi / Type | Voltaj / Voltage (V) | Amper / Current (A) | Koli Adedi / Box Qty | Adet Fiyat Unit Price (Adet/ pcs) |
|------------|--|----------------------|---------------------|----------------------|-----------------------------------|
| IRTU-5020 | No. 0 0.75 - 1.5 mm ² lik 12 Sıra/Poles | 400 | 17.5 | 100 | |
| IRTU-5021 | No. 1 2.5 - 4 mm ² lik 12 Sıra/Poles | 400 | 32 | 50 | |
| IRTU-5022 | No. 2 4 - 6 mm ² lik 12 Sıra/Poles | 400 | 41 | 50 | |
| IRTU-5023 | No. 3 6 - 10 mm ² lik 10 Sıra/Poles | 400 | 57 | 50 | |
| IRTU-5024 | No. 4 10 - 16 mm ² lik 6 Sıra/Poles | 500 | 76 | 50 | |
| IRTU-5025 | No. 5 16 - 25 mm ² lik 6 Sıra/Poles | 500 | 101 | 50 | |
| IRTU-5026 | No. 3 3'lü 6 - 10 mm ² lik | 400 | 57 | 50 | |

Pano İçi Yüksek Isıya Dayanıklı, Vida Blokajlı - (200 °C HA66-VO)
In-Panel High Temperature Resistant, Screw Blocked - (200 °C HA66-VO)



| Kod / Code | Cinsi / Type | Voltaj / Voltage (V) | Amper Current (A) | Koli Adedi / Box Qty | Adet Fiyat Unit Price (Adet/ pcs) |
|------------|--|----------------------|-------------------|----------------------|-----------------------------------|
| IRTU-5029 | No. 0 0.75 - 1.5 mm ² lik 12 Sıra/Poles | 400 | 17.5 | 100 | |
| IRTU-5030 | No. 1 2.5 - 4 mm ² lik 12 Sıra/Poles | 400 | 32 | 50 | |
| IRTU-5031 | No. 2 4 - 6 mm ² lik 12 Sıra/Poles | 400 | 41 | 50 | |
| IRTU-5032 | No. 3 6 - 10 mm ² lik 10 Sıra/Poles | 400 | 57 | 50 | |
| IRTU-5033 | No. 4 10 - 16 mm ² lik 6 Sıra/Poles | 500 | 76 | 50 | |
| IRTU-5034 | No. 5 16 - 25 mm ² lik 6 Sıra/Poles | 500 | 101 | 50 | |
| IRTU-5035 | No. 3 3'lü 6 - 10 mm ² lik | 400 | 57 | 50 | |

Paletli Isıya Dayanıklı, Vida Blokajlı - (Beyaz-Kırmızı) 140 °C V2
Pallet Heat-Resistant, Screw-Blocked - (White-Red) 140 °C V2



| Kod / Code | Cinsi / Type | Voltaj / Voltage (V) | Amper Current (A) | Koli Adedi / Box Qty | Adet Fiyat Unit Price (Adet/ pcs) |
|------------|---|----------------------|-------------------|----------------------|-----------------------------------|
| IRTU-5040 | No. 1 2.5 - 4 mm ² lik 12 Sıra/Poles | 400 | 32 | 50 | |
| IRTU-5041 | No. 2 4 - 6 mm ² lik 12 Sıra/Poles | 400 | 41 | 50 | |
| IRTU-5042 | No. 3 6 - 10 mm ² lik 10 Sıra/Poles | 400 | 57 | 50 | |
| IRTU-5043 | No. 3 3'lü 6 - 10 mm ² lik | 400 | 57 | 50 | |

Paletli Isıya Dayanıklı, Vida Blokajlı - (Şeffaf-Polikarbon)
Pallet Heat-Resistant, Screw-Blocked - (Transparent-Polycarbon)



| Kod / Code | Cinsi / Type | Voltaj / Voltage (V) | Amper Current (A) | Koli Adedi / Box Qty | Adet Fiyat Unit Price (Adet/ pcs) |
|------------|---|----------------------|-------------------|----------------------|-----------------------------------|
| IRTU-5050 | No. 1 2.5 - 4 mm ² lik 12 Sıra/Poles | 400 | 32 | 50 | |
| IRTU-5051 | No. 2 4 - 6 mm ² lik 12 Sıra/Poles | 400 | 41 | 50 | |
| IRTU-5052 | No. 3 6 - 10 mm ² lik 10 Sıra/Poles | 400 | 57 | 50 | |
| IRTU-5053 | No. 3 3'lü 6 - 10 mm ² lik | 400 | 57 | 50 | |

Paletli Yüksek Isıya Dayanıklı, Vida Blokajlı - (200° C HA66-VO)
Pallet High Heat Resistant, Screw Blocked (200° C HA66-VO)



| Kod / Code | Cinsi / Type | Voltaj / Voltage (V) | Amper / Current (A) | Koli Adedi / Box Qty | Adet Fiyat Unit Price (Adet/pcs) |
|------------|---|----------------------|---------------------|----------------------|----------------------------------|
| IRTU-5056 | No. 1 2.5 - 4 mm ² lik 12 Sıra/Poles | 400 | 32 | 50 | |
| IRTU-5057 | No. 2 4 - 6 mm ² lik 12 Sıra/Poles | 400 | 41 | 50 | |
| IRTU-5058 | No. 3 6 - 10 mm ² lik 10 Sıra/Poles | 400 | 57 | 50 | |
| IRTU-5059 | No. 3 3'lü 6 - 10 mm ² lik | 400 | 57 | 50 | |

12' Li Soket Klemens / 12 Socket Connector



| Kod / Code | Cinsi / Type | Koli Adedi / Box Qty | Adet Fiyat Unit Price (Adet/pcs) |
|------------|--|----------------------|----------------------------------|
| IRTU-5060 | No. 1-12'li 2.5 - 4 mm ² lik (Erkek Dişi Geçmeli Kilitli) Male - Female Telescopic Lock System | 30 | 515,00 TL |

2' Li Modüler Sistem Soket Klemensler / 2 Pole Modular System Socket Connector



| Kod / Code | Cinsi / Type | Koli Adedi / Box Qty | Adet Fiyat Unit Price (Adet/pcs) |
|------------|---|----------------------|----------------------------------|
| IRTU-5068 | No. 1 - 2'li Soket Klemensi + Modüler Sistem No. 1 - 2'li Pole Socket Connector + Modular System | 180 | 96,80 TL |

3' Lü Soket Klemens / Trio Socket Connector



| Kod / Code | Cinsi / Type | Koli Adedi / Box Qty | Adet Fiyat Unit Price (Adet/pcs) |
|------------|--|----------------------|----------------------------------|
| IRTU-5065 | No.1 3'lü Soket Klemensi 3 Pole Socket Connector | 100 | 145,00 TL |
| IRTU-5066 | Soket Klemensi Kapağı (Takım) Plastic Cover Set | 45 | 63,50 TL |
| IRTU-5067 | No.1 3'lü Soket Klemensi+Kapak Takımı 3 Pole Socket Connector + Plastic Cover Set | 45 | 208,50 TL |

3' Lü Soket Klemens Bağlantı Aparatı / Trio Socket Connector Connection Apparatus



| Kod / Code | Cinsi / Type | Koli Adedi / Box Qty | Adet Fiyat Unit Price (Adet/pcs) |
|------------|---|----------------------|----------------------------------|
| IRTU-5074 | 2.5 - 4 mm ² T Bağlantı Aparatı T Type Apparatus | 60 | 469,00 TL |

6' Lı Soket Klemens Bağlantı Aparatı / 6' Socket Terminal Connection Device



| Kod / Code | Renk / Color | Cinsi / Type | Koli Ad. / Box Qty | Adet Fiyat Unit Price (Adet/pcs) |
|------------|---------------|---|--------------------|----------------------------------|
| IRTU-5064 | Beyaz / White | No:1, 2,5 - 4 mm ² 6'lı Soket Kapak Takım 6 Pole Socket+Plastic Cover Set | 16 | 459,50 TL |
| IRTU-5063 | Siyah / Black | No:1, 2,5 - 4 mm ² 6'lı Soket Kapak Takım 6 Pole Socket+Plastic Cover Set | 16 | 459,50 TL |

Trafo Klemensleri ve Etiketleri / Transformer Terminal Blocks and Labels



| Kod / Code | Cinsi / Type | Voltaj / Voltage (V) | Amper / Current (A) | Koli Adedi / Box Qty | Adet Fiyat Unit Price (Adet/pcs) |
|-------------|---|----------------------|---------------------|----------------------|----------------------------------|
| IRTU-TK5135 | 1 x 4 mm2 Yüksek Tip 1 x 4 mm2 High Type | 400 | 24 | 200 | 60,50 TL |
| IRTU-TK5136 | 2 x 4 mm2 Yüksek Tip 2 x 4 mm2 High Type | 400 | 24 | 100 | 85,50 TL |
| IRTU-TK5137 | 1 x 6 mm2 Yüksek Tip 1 x 6 mm2 High Type | 400 | 41 | 100 | 67,50 TL |
| IRTU-TK5139 | Trafo Klemens Etik. Yazısız Transformer Terminals Sticker Printless | | | 500 | 1,20 TL |
| IRTU-TK5140 | Trafo Klemens Etik. Yazılı Transformer Terminals Sticker Printed | | | 500 | 2,60 TL |

Steatit Klemensler / Steatite Terminals



| Kod / Code | Cinsi / Type | Koli Adedi / Box Qty | Adet Fiyat Unit Price (Adet/pcs) |
|------------|--|----------------------|----------------------------------|
| IRTU-5081 | No. 0 2'li Steatit Klemens / Steatite Terminal | 150 | |
| IRTU-5082 | No. 1 2'li Steatit Klemens / Steatite Terminal | 150 | |
| IRTU-5083 | No. 1 3'lü Steatit Klemens / Steatite Terminal | 100 | |
| IRTU-5084 | No. 2 2'li Steatit Klemens / Steatite Terminal | 100 | |
| IRTU-5085 | No. 2 3'lü Steatit Klemens / Steatite Terminal | 50 | |
| IRTU-5086 | No. 3 2'li Steatit Klemens / Steatite Terminal | 50 | |
| IRTU-5087 | No. 3 3'lü Steatit Klemens / Steatite Terminal | 35 | |
| IRTU-5088 | No. 0 1'li Steatit Klemens / Steatite Terminal | 400 | |
| IRTU-5089 | No. 1 1'li Steatit Klemens / Steatite Terminal | 350 | |
| IRTU-5090 | No. 2 1'li Steatit Klemens / Steatite Terminal | 200 | |
| IRTU-5091 | No. 3 1'li Steatit Klemens / Steatite Terminal | 100 | |
| IRTU-5093 | No. 4 3'lü Steatit Klemens (Kondansatör için) Steatite Terminal (ForCapacitor) | 20 | |
| IRTU-5094 | No. 5 3'li Steatit Klemens / Steatite Terminal | 20 | |
| IRTU-5095 | No. 5 2'lü Steatit Klemens / Steatite Terminal | 20 | |

Kapaklı Terminal Klemensler / LID Terminal Connectors



| Kod / Code | Cinsi / Type | Koli Adedi / Box Qty | Adet Fiyat Unit Price (Adet/pcs) |
|-------------|-----------------------|----------------------|----------------------------------|
| İRTU - 5145 | 25 A 600V Terminal-3 | 50 | |
| İRTU - 5146 | 25 A 600V Terminal-4 | 50 | |
| İRTU - 5147 | 25 A 600V Terminal-6 | 50 | |
| İRTU - 5148 | 25 A 600V Terminal-12 | 25 | |

IP-68 Polyamid Kablo Rakoru / IP-68 Polyamide Cable Gland

| Kod / Code | Ölçü / Size | Renk / Color | Montaj Çapı / Mounting Diameter (mm) | Kutu Adedi / Box Qty. | Birim Fiyatı / Unit Price (Adet/pcs) |
|------------|-------------|--------------|--------------------------------------|-----------------------|--------------------------------------|
| IRTU-K1007 | PG-7 | | 12,5 | 450 | |
| IRTU-K1009 | PG-9 | | 15,5 | 300 | |
| IRTU-K1011 | PG-11 | | 18,5 | 200 | |
| IRTU-K1013 | PG-13,5 | | 20,5 | 175 | |
| IRTU-K1016 | PG-16 | | 22,5 | 125 | |
| IRTU-K1021 | PG-21 | | 28,5 | 75 | |
| IRTU-K1029 | PG-29 | | 37,5 | 40 | |
| IRTU-K1036 | PG-36 | | 47,5 | 20 | |
| IRTU-K1042 | PG-42 | | 55 | 15 | |
| IRTU-K1048 | PG-48 | | 60 | 12 | |
| IRTU-K2012 | M12X1,5 | | 12 | 450 | |
| IRTU-K2016 | M16X1,5 | | 16 | 200 | |
| IRTU-K2020 | M20X1,5 | | 20 | 150 | |
| IRTU-K2025 | M25X1,5 | | 25 | 75 | |
| IRTU-K2032 | M32X1,5 | | 32 | 40 | |
| IRTU-K2040 | M40X1,5 | | 40 | 20 | |



Pirinç Kablo Rakoru IP68 (Nikel Kaplı) / Brass Cable Gland (Nickel Plated)

| PG Kod / PG Code | Dış Ölçüsü / Size | Kablo Çapı / Cable Diameter (Min-Max) mm | Koli Adedi / Box Qty | Birim Fiyat / Unit Price (Adet/pcs) | Metrik Kod / Metric Code | Dış Ölçüsü / Size | Birim Fiyat / Unit Price (Adet/pcs) |
|------------------|-------------------|--|----------------------|-------------------------------------|--------------------------|-------------------|-------------------------------------|
| IRTU-K3007 | PG7 | 3,0 - 6,5 | 50 | | IRTU-K4012 | M12x1,5 | |
| IRTU-K3009 | PG9 | 4,0 - 8,0 | 50 | | IRTU-K4016 | M16x1,5 | |
| IRTU-K3011 | PG11 | 5,0 - 10,0 | 50 | | | | |
| IRTU-K3013 | PG13,5 | 6,0 - 12,0 | 50 | | IRTU-K4020 | M20x1,5 | |
| IRTU-K3016 | PG16 | 10,0 - 14,0 | 25 | | IRTU-K4025 | M25x1,5 | |
| IRTU-K3021 | PG21 | 13,0 - 18,0 | 25 | | IRTU-K4032 | M32x1,5 | |
| IRTU-K3025 | PG25 | 14,0 - 26,0 | 25 | | | | |
| IRTU-K3029 | PG29 | 18,0 - 25,0 | 20 | | IRTU-K4040 | M40x1,5 | |
| IRTU-K3036 | PG36 | 22,0 - 32,0 | 10 | | IRTU-K4050 | M50x1,5 | |
| IRTU-K3042 | PG42 | 30,0 - 38,0 | 10 | | | | |
| IRTU-K3048 | PG48 | 34,0-44,0 | 10 | | IRTU-K4063 | M63x1,5 | |

Kelepçeli Pirinç Rakor IP55
Brass Cable Gland with Clamp IP55

| Kod Code | Dış Ölçüsü / Size | Kablo Çapı / Cable Diameter (Min-Max) mm | Koli Adedi / Box Qty | Birim Fiyat / Unit Price (Adet/pcs) |
|------------|-------------------|--|----------------------|-------------------------------------|
| IRTU-K6007 | PG7 | 3,0 - 6,0 | 100 | |
| IRTU-K6009 | PG9 | 6,0 - 9,0 | 100 | |
| IRTU-K6011 | PG11 | 7,0 - 10,0 | 100 | |
| IRTU-K6013 | PG13,5 | 8,0 - 12,0 | 100 | |
| IRTU-K6016 | PG16 | 10,0 - 14,0 | 100 | |
| IRTU-K6021 | PG21 | 14,0 - 20,0 | 100 | |
| IRTU-K6025 | PG25 | 20,0 - 24,0 | 100 | |
| IRTU-K6029 | PG29 | 24,0 - 29,0 | 50 | |
| IRTU-K6036 | PG36 | 30,0 - 35,0 | 50 | |
| IRTU-K6042 | PG42 | 35,0 - 40,0 | 10 | |
| IRTU-K6048 | PG48 | 40,0 - 45,0 | 10 | |
| IRTU-K6055 | PG55 | 43,0 - 49,0 | 10 | |

Pirinç Kablo Rakoru IP55
Brass Cable Gland IP55

| Kod / Code | Dış Ölçüsü / Size | Kablo Çapı / Cable Diameter (Min-Max) mm | Koli Adedi / Box Qty | Birim Fiyat / Unit Price (Adet/pcs) |
|------------|-------------------|--|----------------------|-------------------------------------|
| IRTU-K5007 | PG7 | 3,0 - 6,0 | 100 | |
| IRTU-K5009 | PG9 | 6,0 - 9,0 | 100 | |
| IRTU-K5011 | PG11 | 7,0 - 10,0 | 100 | |
| IRTU-K5013 | PG13,5 | 8,0 - 12,0 | 100 | |
| IRTU-K5016 | PG16 | 10,0 - 14,0 | 100 | |
| IRTU-K5021 | PG21 | 14,0 - 20,0 | 100 | |
| IRTU-K5025 | PG25 | 20,0 - 24,0 | 100 | |
| IRTU-K5029 | PG29 | 24,0 - 29,0 | 50 | |
| IRTU-K5036 | PG36 | 30,0 - 35,0 | 50 | |
| IRTU-K5042 | PG42 | 35,0 - 40,0 | 10 | |
| IRTU-K5048 | PG48 | 40,0 - 45,0 | 10 | |
| IRTU-K5055 | PG55 | 43,0 - 49,0 | 10 | |

PG Polyamid Somun
PG Polyamide Nuts



| Kod / Code | Ölçü / Size | Kutu Adedi / Box Qty. | Birim Fiyatı Unit Price (Adet/pcs) |
|-------------|-------------|-----------------------|------------------------------------|
| IRTU-PS1007 | PG-7 | 250 | |
| IRTU-PS1009 | PG-9 | 250 | |
| IRTU-PS1011 | PG-11 | 250 | |
| IRTU-PS1013 | PG-13,5 | 250 | |
| IRTU-PS1016 | PG-16 | 250 | |
| IRTU-PS1021 | PG-21 | 250 | |
| IRTU-PS1029 | PG-29 | 150 | |
| IRTU-PS1036 | PG-36 | 100 | |
| IRTU-PS1042 | PG-42 | 100 | |
| IRTU-PS1048 | PG-48 | 100 | |

Metrik Polyamid Somun
Metric Polyamide Nuts

| Kod / Code | Ölçü / Size | Kutu Adedi / Box Qty. | Birim Fiyatı Unit Price (Adet/pcs) |
|-------------|-------------|-----------------------|------------------------------------|
| IRTU-PS2012 | M12X1,5 | 250 | |
| IRTU-PS2016 | M16X1,5 | 250 | |
| IRTU-PS2020 | M20X1,5 | 250 | |
| IRTU-PS2025 | M25X1,5 | 250 | |
| IRTU-PS2032 | M32X1,5 | 250 | |
| IRTU-PS2040 | M40X1,5 | 250 | |

PG Pirinç Nikel Kaplı Somun
Metal Nut Nickel Plated PG Size



| Kod / Code | Ölçüsü / Size | Ambalaj Miktarı Packing Qty | Birim Fiyat Unit Price (Adet/pcs) |
|-------------|---------------|-----------------------------|-----------------------------------|
| IRTU-PS3009 | PG9 | 100 | |
| IRTU-PS3011 | PG11 | 100 | |
| IRTU-PS3013 | PG13,5 | 100 | |
| IRTU-PS3016 | PG16 | 100 | |
| IRTU-PS3021 | PG21 | 100 | |
| IRTU-PS3025 | PG25 | 50 | |
| IRTU-PS3029 | PG29 | 50 | |
| IRTU-PS3036 | PG36 | 25 | |
| IRTU-PS3042 | PG42 | 10 | |
| IRTU-PS3048 | PG48 | 10 | |

Metrik Pirinç Nikel Kaplı Somun
Metal Nut Nickel Plated Metric Size

| Kod / Code | Ölçüsü / Size | Ambalaj Miktarı Packing Qty | Birim Fiyat Unit Price (Adet/pcs) |
|-------------|---------------|-----------------------------|-----------------------------------|
| IRTU-PS4012 | M12x1,5 | 100 | |
| IRTU-PS4016 | M16x1,5 | 100 | |
| IRTU-PS4020 | M20x1,5 | 100 | |
| IRTU-PS4025 | M25x1,5 | 100 | |
| IRTU-PS4032 | M32x1,5 | 50 | |
| IRTU-PS4040 | M40x1,5 | 50 | |
| IRTU-PS4050 | M50x1,5 | 10 | |
| IRTU-PS4063 | M63x1,5 | 10 | |

PG Pirinç Körtapa Nikel Kaplamalı
Pg Metal Blind Stop Nickel Plated



| Kod / Code | Ölçüsü / Size | Ambalaj Miktarı Packing Qty | Birim Fiyat Unit Price (Adet/pcs) |
|-------------|---------------|-----------------------------|-----------------------------------|
| IRTU-KT2009 | PG9 | 50 | |
| IRTU-KT2011 | PG11 | 50 | |
| IRTU-KT2013 | PG13,5 | 50 | |
| IRTU-KT2016 | PG16 | 50 | |
| IRTU-KT2021 | PG21 | 50 | |
| IRTU-KT2025 | PG25 | 50 | |
| IRTU-KT2029 | PG29 | 50 | |
| IRTU-KT2036 | PG36 | 50 | |
| IRTU-KT2042 | PG42 | 50 | |
| IRTU-KT2048 | PG48 | 50 | |

Metrik Pirinç Nikel Kaplı Somun
Metric Metal Lock Nut Nickel Plated

| Kod / Code | Ölçüsü / Size | Ambalaj Miktarı Packing Qty | Birim Fiyat Unit Price (Adet/pcs) |
|-------------|---------------|-----------------------------|-----------------------------------|
| IRTU-KT3012 | M12x1,5 | 50 | |
| IRTU-KT3016 | M16x1,5 | 50 | |
| IRTU-KT3020 | M20x1,5 | 50 | |
| IRTU-KT3025 | M25x1,5 | 50 | |
| IRTU-KT3032 | M32x1,5 | 50 | |
| IRTU-KT3040 | M40x1,5 | 50 | |
| IRTU-KT3050 | M50x1,5 | 50 | |
| IRTU-KT3063 | M63x1,5 | 50 | |

Çelik Spiral Boru / Steel Spiral Pipe

| Standart Kod / Code | İç Çap / Inside Diameter (mm) | NPT Ölçü / NPT Dimensions | Ambalaj Miktarı / Packing Qty. (mt) | Standart Birim Fiyat / Unit Price (\$ / mt) | PVC Kaplı Kod / Code | PVC Kaplı Birim Fiyat / Unit Price (\$ / mt) |
|---------------------|-------------------------------|---------------------------|-------------------------------------|---|----------------------|--|
| IRTU-CGS09 | 9 | 1/4" | 50 | | IRTU-PGS09 | |
| IRTU-CGS11 | 11 | 3/8" | 50 | | IRTU-PGS11 | |
| IRTU-CGS14 | 14 | | 50 | | IRTU-PGS14 | |
| IRTU-CGS16 | 16 | 1/2" | 50 | | IRTU-PGS16 | |
| IRTU-CGS18 | 18 | | 50 | | IRTU-PGS18 | |
| IRTU-CGS21 | 21 | 3/4" | 50 | | IRTU-PGS21 | |
| IRTU-CGS26 | 26 | 1" | 25 | | IRTU-PGS26 | |
| IRTU-CGS29 | 29 | | 25 | | IRTU-PGS29 | |
| IRTU-CGS32 | 32 | | 25 | | IRTU-PGS32 | |
| IRTU-CGS35 | 35 | 1 1/4" | 25 | | IRTU-PGS35 | |
| IRTU-CGS37 | 37 | | 25 | | IRTU-PGS37 | |
| IRTU-CGS40 | 40 | 1 1/2" | 25 | | IRTU-PGS40 | |
| IRTU-CGS42 | 42 | | 25 | | IRTU-PGS42 | |
| IRTU-CGS45 | 45 | | 25 | | IRTU-PGS45 | |
| IRTU-CGS50 | 50 | 2" | 25 | | IRTU-PGS50 | |



STANDART



PVC KAPLI

Çelik Spiral Boru Kılavuz Telli Steel Spiral Pipe with Wire

| Standart Kod / Code | İç Çap / Inside Diameter (mm) | NPT Ölçü / NPT Dimensions | Ambalaj Miktarı / Packing Qty. (mt) | Standart Birim Fiyat / Unit Price (\$ / mt) | PVC Kaplı Kod / Code | PVC Kaplı Kod / Code |
|---------------------|-------------------------------|---------------------------|-------------------------------------|---|----------------------|----------------------|
| IRTU-PGS211 | 11 | 3/8" | 50 | | IRTU-CGS211 | |
| IRTU-PGS214 | 14 | | 50 | | IRTU-CGS214 | |
| IRTU-PGS216 | 16 | 1/2" | 50 | | IRTU-CGS216 | |
| IRTU-PGS218 | 18 | | 50 | | IRTU-CGS218 | |
| IRTU-PGS221 | 21 | 3/4" | 50 | | IRTU-CGS221 | |
| IRTU-PGS226 | 26 | 1" | 25 | | IRTU-CGS226 | |
| IRTU-PGS229 | 29 | | 25 | | IRTU-CGS229 | |
| IRTU-PGS232 | 32 | | 25 | | IRTU-CGS232 | |
| IRTU-PGS235 | 35 | 1 1/4" | 25 | | IRTU-CGS235 | |
| IRTU-PGS237 | 37 | | 25 | | IRTU-CGS237 | |



STANDART



PVC KAPLI

Çelik Tel Örgülü Spiral Boru Steel Wire Braided Spiral Pipe

| Standart Kod / Code | Anma Ölçüsü / Size | İç Çap / Inside Diameter (mm) | Dış Çap / Outer Diameter (mm) | Ambalaj Miktarı / Packing Qty. (mt) | Standart Birim Fiyat / Unit Price (\$ / mt) | PVC Kaplı Kod / Code | PVC Kaplı Birim Fiyat / Unit Price (\$ / mt) |
|---------------------|--------------------|-------------------------------|-------------------------------|-------------------------------------|---|----------------------|--|
| IRTU-CTS09 | 1/4" | 10,0 | 16,0 | 50 | | IRTU-PTS09 | |
| IRTU-CTS12 | 3/8" | 12,0 | 16,0 | 50 | | IRTU-PTS12 | |
| IRTU-CTS16 | 1/2" | 15,5 | 19,0 | 50 | | IRTU-PTS16 | |
| IRTU-CTS21 | 3/4" | 20,5 | 27,0 | 50 | | IRTU-PTS21 | |
| IRTU-CTS27 | 1" | 26,5 | 35,0 | 25 | | IRTU-PTS27 | |
| IRTU-CTS35 | 1 1/4" | 34,5 | 42,0 | 25 | | IRTU-PTS35 | |
| IRTU-CTS40 | 1 1/2" | 39,5 | 48,0 | 25 | | IRTU-PTS40 | |
| IRTU-CTS50 | 2" | 50,5 | 60,0 | 25 | | IRTU-PTS50 | |



STANDART



PVC KAPLI

PVC Kaplı Galvaniz Çelik Spiral Boru Ağır Hizmet Tipi PVC Coated Galvanised Steel Spiral Pipe Heavy Duty

| Kod / Code | Anma Ölçüsü / Size | İç Çap / Inside Diameter (mm) | Dış Çap / Outer Diameter (mm) | Ambalaj Miktarı / Packing Qty. (mt) | Birim Fiyat / Unit Price (\$ / mt) |
|------------|--------------------|-------------------------------|-------------------------------|-------------------------------------|------------------------------------|
| IRTU-EF10 | 1/4" | 10,0 | 15,0 | 30 | |
| IRTU-EF12 | 3/8" | 12,0 | 18,0 | 30 | |
| IRTU-EF16 | 1/2" | 15,5 | 21,5 | 30 | |
| IRTU-EF21 | 3/4" | 20,5 | 27,0 | 30 | |
| IRTU-EF27 | 1" | 26,5 | 33,0 | 30 | |
| IRTU-EF35 | 1 1/4" | 34,5 | 43,0 | 15 | |
| IRTU-EF40 | 1 1/2" | 39,5 | 48,0 | 15 | |
| IRTU-EF50 | 2" | 50,5 | 60,0 | 15 | |
| IRTU-EF65 | 2 1/2" | 65,0 | 72,0 | 7,5 | |
| IRTU-EF75 | 3" | 75,0 | 87,0 | 7,5 | |



Polyamid (PA6) ve Polipropilen (PP) Spiral Borular
Polyamide (PA6) and Polypropylene (PP) Spiral Conduits

| Polyamid Kod / Code | Ölçü / Size | Renk / Color | İç Çap / Inside Diameter (mm) | Dış Çap / Outer Diameter (mm) | Ambalaj Miktarı / Packing Qty. (mt) | Polyamid Birim Fiyat Unit Price (\$/mt) | Polipropilen Kod / Code | Polipropilen Birim Fiyat Unit Price (\$/mt) |
|---------------------|-------------|--------------|-------------------------------|-------------------------------|-------------------------------------|---|-------------------------|---|
| IRTU-PA6-07 | PA7 | | 6,5 | 10,0 | 100 | | IRTU-PP07 | |
| IRTU-PA6-8,5 | PA8,5 | | 8,5 | 12,0 | 100 | | IRTU-PP8,5 | |
| IRTU-PA6-10 | PA10 | | 10,0 | 13,0 | 100 | | IRTU-PP10 | |
| IRTU-PA6-12 | PA12 | | 12,0 | 16,0 | 50 | | IRTU-PP12 | |
| IRTU-PA6-14 | PA14 | | 14,0 | 18,5 | 50 | | IRTU-PP14 | |
| IRTU-PA6-17 | PA17 | | 17,0 | 21,5 | 50 | | IRTU-PP17 | |
| IRTU-PA6-19 | PA19 | | 19,0 | 24,0 | 50 | | IRTU-PP19 | |
| IRTU-PA6-22 | PA22 | | 22,0 | 27,5 | 50 | | IRTU-PP22 | |
| IRTU-PA6-23 | PA23 | | 23,0 | 28,7 | 50 | | IRTU-PP23 | |
| IRTU-PA6-26 | PA26 | | 26,0 | 31,0 | 25 | | IRTU-PP26 | |
| IRTU-PA6-29 | PA29 | | 29,0 | 34,5 | 25 | | IRTU-PP29 | |
| IRTU-PA6-36 | PA36 | | 36,0 | 42,5 | 25 | | IRTU-PP36 | |
| IRTU-PA6-48 | PA48 | | 48,0 | 54,5 | 25 | | IRTU-PP48 | |



Polyamid



Polipropilen

Polyamid (PA6) Spiral Boru Rakorları (Somunlu)
Polyamide (PA6) Spiral Conduit Glants (Nut)

| Polyamid Kod / Code | Ölçü / Size | Renk / Color | Uygun Spiral Suitable Con. | Ambalaj Miktarı P. Qty. (mt) | Birim Fiyat Unit Price (\$/mt) | 90° Polyamid Kod / Code | Ambalaj Miktarı P. Qty. (mt) | Birim Fiyat Unit Price (\$/mt) |
|---------------------|-------------|--------------|----------------------------|------------------------------|--------------------------------|-------------------------|------------------------------|--------------------------------|
| IRTU-AGP07 | PG7 | | PA8,5 | 50 | | IRTU-AGP90-07 | 25 | |
| IRTU-AGP09 | PG9 | | PA10 | 50 | | IRTU-AGP90-09 | 25 | |
| IRTU-AGP11 | PG11 | | PA12 | 50 | | IRTU-AGP90-11 | 25 | |
| IRTU-AGP13 | PG13,5 | | PA14 | 50 | | IRTU-AGP90-13 | 25 | |
| IRTU-AGP16 | PG16 | | PA17 | 50 | | IRTU-AGP90-16 | 25 | |
| IRTU-AGP21 | PG21 | | PA23 | 25 | | IRTU-AGP90-21 | 25 | |
| IRTU-AGP29 | PG29 | | PA29 | 20 | | IRTU-AGP90-29 | 10 | |
| IRTU-AGP36 | PG36 | | PA36 | 20 | | IRTU-AGP90-36 | 10 | |
| IRTU-AGP48 | PG48 | | PA48 | 20 | | IRTU-AGP90-48 | 10 | |



Standart



90°

Geçmeli Tip Polyamid Spiral Boru Rakoru PG
Polyamide Flexible Conduit Connector

| Kod / Code | Ölçü / Size | Renk / Color | Uygun Spiral / Suitable Conduit | Ambalaj Miktarı / Packing Qty. (mt) | Birim Fiyat Unit Price (Adet/pcs) |
|-------------|-------------|--------------|---------------------------------|-------------------------------------|-----------------------------------|
| IRTU-PG0707 | PG7 | | PA8,5 | 100 | |
| IRTU-PG0910 | PG9 | | PA10 | 50 | |
| IRTU-PG1112 | PG11 | | PA12 | 50 | |
| IRTU-PG1314 | PG13,5 | | PA14 | 50 | |
| IRTU-PG1617 | PG16 | | PA17 | 50 | |
| IRTU-PG2123 | PG21 | | PA23 | 25 | |
| IRTU-PG2929 | PG29 | | PA29 | 25 | |
| IRTU-PG3636 | PG36 | | PA36 | 10 | |
| IRTU-PG4848 | PG48 | | PA48 | 10 | |



Polyamid (PA6) Spiral Boru Klipsi
Polyamide Flexible Conduit Clip

| Kod / Code | Ölçü / Size | Renk / Color | Uygun Spiral / Suitable Conduit | Ambalaj Miktarı / Packing Qty. (mt) | Birim Fiyat Unit Price (Adet/pcs) |
|------------|-------------|--------------|---------------------------------|-------------------------------------|-----------------------------------|
| IRTU-TK07 | PG7 | | PA8,5 | 100 | |
| IRTU-TK09 | PG9 | | PA10 | 100 | |
| IRTU-TK11 | PG11 | | PA12 | 100 | |
| IRTU-TK13 | PG13,5 | | PA14 | 50 | |
| IRTU-TK16 | PG16 | | PA17 | 50 | |
| IRTU-TK21 | PG21 | | PA23 | 50 | |
| IRTU-TK29 | PG29 | | PA29 | 25 | |
| IRTU-TK36 | PG36 | | PA36 | 25 | |
| IRTU-TK48 | PG48 | | PA48 | 25 | |



Galvaniz Çelik Liquiditte Spiral Boru Rakoru (Erkek Tip) IP68

Galvanized Steel Liquiditte Spiral Pipe Gland (Male Type) IP68



| Kod / Code | PG Serisi PG Series | Birim Fiyat Unit Price (Adet/Pcs) | Kod / Code | Metrik Serisi Metric Series | Birim Fiyat Unit Price (Adet/Pcs) | Kod / Code | NPT Serisi NPT Series | Spiral Ölç. Size | Birim Fiyat Unit Price (Adet/Pcs) |
|----------------|------------------------|---|-------------|--------------------------------|---|---------------|--------------------------|---------------------|---|
| IRTU-GSPRG11 | PG11 | | IRTU-GSRM16 | M16 x 1,5 | | IRTU-GSNPT038 | 3/8" | 3/8" | |
| IRTU-GSPRG13,5 | PG13,5 | | IRTU-GSRM20 | M20 x 1,5 | | IRTU-GSNPT012 | 1/2" | 1/2" | |
| IRTU-GSPRG21 | PG21 | | IRTU-GSRM25 | M25 x 1,5 | | IRTU-GSNPT034 | 3/4" | 1/2" | |
| IRTU-GSPRG29 | PG29 | | IRTU-GSRM32 | M32 x 1,5 | | IRTU-GSNPT100 | 1" | 1" | |
| IRTU-GSPRG36 | PG36 | | IRTU-GSRM40 | M40 x 1,5 | | IRTU-GSNPT114 | 1 1/4" | 1 1/4" | |
| IRTU-GSPRG42 | PG42 | | IRTU-GSRM50 | M50 x 1,5 | | IRTU-GSNPT112 | 1 1/2" | 1 1/2" | |
| IRTU-GSPRG48 | PG48 | | IRTU-GSRM63 | M63 x 1,5 | | IRTU-GSNPT200 | 2" | 2" | |

Pirinç Nikel Kaplı Sabit Tip Spiral Rakoru IP54

Nickel Plated Brass Spiral Gland Fixed Type IP54



| Kod / Code | PG Serisi PG Series | Spiral Ölç. Size | Birim Fiyat Unit Price (Adet/Pcs) | Kod / Code | Metrik Serisi Metric Series | Spiral Ölç. Size | Birim Fiyat Unit Price (Adet/Pcs) | Kod / Code | NPT | Spiral Ölç. Size | Birim Fiyat Unit Price (Adet/Pcs) |
|------------|------------------------|---------------------|---|------------|--------------------------------|---------------------|---|------------|--------|---------------------|---|
| IRTU-SPR11 | PG11 | PG11 | | İRSMR-16 | M16 x 1,5 | 3/8" | | İRNSR-12 | 3/8" | 3/8" | |
| IRTU-SPR13 | PG13,5 | PG13,5 | | İRSMR-20 | M20 x 1,5 | 1/2" | | İRNSR-12S | 1/2" | 1/2" | |
| IRTU-SPR21 | PG21 | PG21 | | İRSMR-25 | M25 x 1,5 | 3/4" | | İRNSR-34 | 3/4" | 3/4" | |
| IRTU-SPR29 | PG29 | PG29 | | İRSMR-32 | M32 x 1,5 | 1" | | İRNSR-100 | 1" | 1" | |
| IRTU-SPR36 | PG36 | PG36 | | İRSMR-40 | M40 x 1,5 | 1 1/4" | | İRNSR-114 | 1 1/4" | 1 1/4" | |
| IRTU-SPR42 | PG42 | PG42 | | İRSMR-50 | M50 x 1,5 | 1 1/2" | | İRNSR-112 | 1 1/2" | 1 1/2" | |
| IRTU-SPR48 | PG48 | PG48 | | İRSMR-63 | M63 x 1,5 | 2" | | İRNSR-200 | 2" | 2" | |
| | | | | | | | | İRNSR-212 | 2 1/2" | 2 1/2" | |
| | | | | | | | | İRNSR-300 | 3" | 3" | |
| | | | | | | | | İRNSR-400 | 4" | 4" | |

Pirinç Nikel Kaplı Boru Rakoru Erkek Tip - Ağır Hizmet (IP68)

Nickel Plated Brass Spiral Gland Male Type - Heavy Duty IP68



| Kod / Code | PG Serisi PG Series | Spiral Ölç. Size | Birim Fiyat Unit Price (Adet/Pcs) | Kod / Code | Metrik Serisi Metric Series | Spiral Ölç. Size | Birim Fiyat Unit Price (Adet/Pcs) | Kod / Code | NPT | Spiral Ölç. Size | Birim Fiyat Unit Price (Adet/Pcs) |
|-------------|------------------------|---------------------|---|-------------|--------------------------------|---------------------|---|-------------|--------|---------------------|---|
| IRTU-BBFP09 | PG9 | PG9 | | IRTU-BBFM16 | M16 x 1,5 | 1/4" | | IRTU-BBFN01 | 1/4" | 1/4" | |
| IRTU-BBFP11 | PG11 | PG11 | | IRTU-BBFM16 | M16 x 1,5 | 3/8" | | IRTU-BBFN02 | 3/8" | 3/8" | |
| IRTU-BBFP14 | PG13,5 | PG16 | | IRTU-BBFM20 | M16 x 1,5 | 1/2" | | IRTU-BBFN03 | 1/2" | 1/2" | |
| IRTU-BBFP16 | PG16 | PG16 | | | | | | IRTU-BBFN04 | 3/4" | 3/4" | |
| IRTU-BBFP21 | PG21 | PG21 | | IRTU-BBFM25 | M25 x 1,5 | 1" | | IRTU-BBFN05 | 1" | 1" | |
| IRTU-BBFP29 | PG29 | PG29 | | IRTU-BBFM32 | M32 x 1,5 | 1 1/4" | | IRTU-BBFN06 | 1 1/4" | 1" | |
| IRTU-BBFP36 | PG36 | PG36 | | IRTU-BBFM40 | M40 x 1,5 | 1 1/4" | | IRTU-BBFN07 | 1 1/2" | 1 1/4" | |
| IRTU-BBFP42 | PG42 | PG42 | | IRTU-BBFM50 | M50 x 1,5 | 1 1/2" | | IRTU-BBFN08 | 2" | 2" | |
| IRTU-BBFP48 | PG48 | PG48 | | IRTU-BBFM63 | M63 x 1,5 | 2" | | | | | |

AKIM TRAFOLARI



**BARA
GEÇİŞLİ
TRAFOLAR**



**KENDİNDEN
BARALI
TRAFOLAR**



**KENDİNDEN
KLEMENSLİ
TRAFOLAR**



**KABLO
GEÇİŞLİ
TRAFOLAR**



**AILABİLİR
TRAFOLAR**

UN-311

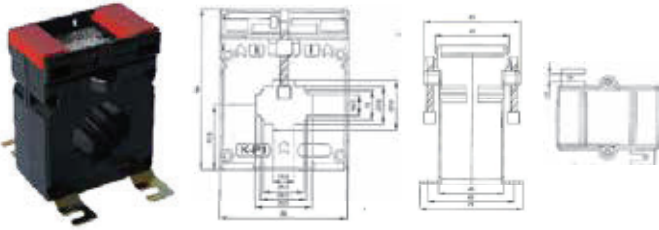

| Akım / Primacy / Secondary | Ölçme Sınıfı / | Güç (VA) | Birim Fiyat Unit Price (Adet/pcs) |
|---|-------------------|----------------------|---|
| 20/5 - 25/5 - 30/5 - 40/5 - 50/5 - 60/5 75/5 - 80/5 100/5 - 125/5 - 150/5 - 200/5 - 250/5 300/5 - 400/5 - 500/5 - 600/5 | 0,5 - 0,5S 1-3 | 1 1,5 2,5 5 | ☎ |
| 20/1 - 25/1 - 30/1 - 40/1 - 50/1 - 60/1 75/1 - 80/1 100/1 - 125/1 - 150/1 - 200/1 - 250/1 300/1 - 400/1 - 500/1 - 600/1 | 0,5 - 0,5S 1-3 | 1 1,5 2,5 5 | |

UN-312

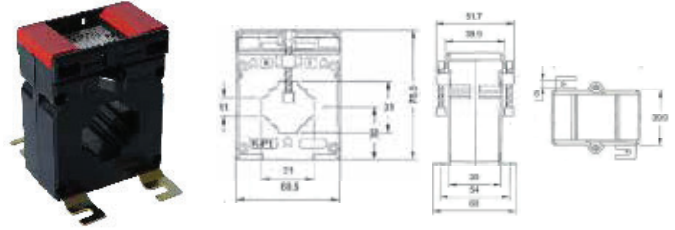

| Akım / Primacy / Secondary | Ölçme Sınıfı / | Güç (VA) | Birim Fiyat Unit Price (Adet/pcs) |
|---|-------------------|----------------------|---|
| 20/5 - 25/5 - 30/5 - 40/5 - 50/5 - 60/5 75/5 - 80/5 100/5 - 125/5 - 150/5 - 200/5 - 250/5 300/5 - 400/5 - 500/5 - 600/5 | 0,5 - 0,5S 1-3 | 1 1,5 2,5 5 | ☎ |
| 20/1 - 25/1 - 30/1 - 40/1 - 50/1 - 60/1 75/1 - 80/1 100/1 - 125/1 - 150/1 - 200/1 - 250/1 300/1 - 400/1 - 500/1 - 600/1 | 0,5 - 0,5S 1-3 | 1 1,5 2,5 5 | |

UN-410

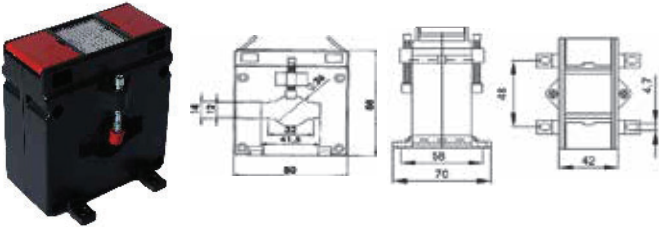

| Akım / Primacy / Secondary | Ölçme Sınıfı / | Güç (VA) | Birim Fiyat Unit Price (Adet/pcs) |
|---|--------------------------|------------------------------------|---|
| 75/5 - 80/5 - 100/5 - 125/5 - 150/5 200/5 - 250/5 - 300/5 - 400/5 - 500/5 600/5 - 700/5 750/5 - 800/5 | 0,2 - 0,5 0,5S 1-3 | 1-1,25-1,5 2,5-5-10 15-20-30 | ☎ |
| 75/1 - 80/1 - 100/1 - 125/1 - 150/1 200/1 - 250/1 - 300/1 - 400/1 - 500/1 600/1 - 700/1 - 750/1 - 800/1 | 0,2 - 0,5 0,5S 1-3 | 1-1,25-1,5 2,5-5-10 15-20-30 | |

UN-411

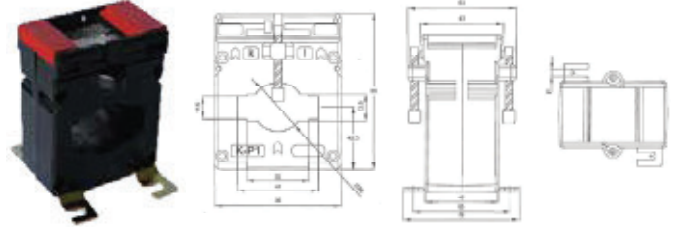

| Akım / Primacy / Secondary | Ölçme Sınıfı / | Güç (VA) | Birim Fiyat Unit Price (Adet/pcs) |
|--|--------------------------|------------------------------------|---|
| 40/5 - 50/5 - 60/5 - 75/5 - 80/5 - 100/5 125/5 - 150/5 - 200/5 - 250/5 - 300/5 400/5 - 500/5 - 600/5 - 700/5 - 750/5 800/5 | 0,2 - 0,5 0,5S 1-3 | 1-1,25-1,5 2,5-5-10 15-20-30 | ☎ |
| 40/1 - 50/1 - 60/1 - 75/1 - 80/1 - 100/1 125/1 - 150/1 - 200/1 - 250/1 - 300/1 400/1 - 500/1 - 600/1 - 700/1 - 750/1 - 800/1 | 0,2 - 0,5 0,5S 1-3 | 1-1,25-1,5 2,5-5-10 15-20-30 | |

UN-412

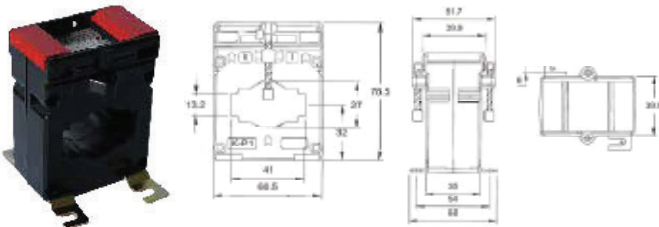

| Akım / Primacy / Secondary | Ölçme Sınıfı / | Güç (VA) | Birim Fiyat Unit Price (Adet/pcs) |
|---|--------------------------|-------------------------------|---|
| 50/5 - 60/5 - 75/5 - 80/5 100/5 - 125/5 150/5 - 200/5 - 250/5 300/5 - 400/5 500/5 - 600/5 - 700/5 - 750/5 - 800/5 | 0,2 - 0,5 0,5S 1-3 | 1 - 1,5 2,5 - 5 10 - 15 | ☎ |
| 50/1 - 60/1 - 75/1 - 80/1 100/1 - 125/1 150/1 - 200/1 - 250/1 300/1 - 400/1 500/1 - 600/1 - 700/1 - 750/1 - 800/1 | 0,2 - 0,5 0,5S 1-3 | 1 - 1,5 2,5 - 5 10 - 15 | |

UN-510

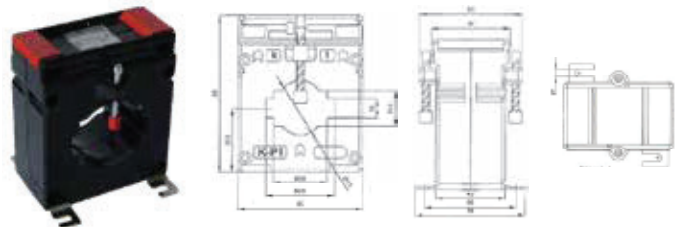

| Akım / Primacy / Secondary | Ölçme Sınıfı / | Güç (VA) | Birim Fiyat Unit Price (Adet/pcs) |
|--|--------------------------|------------------------------------|---|
| 150/5 - 200/5 - 250/5 - 300/5 - 400/5 500/5 - 600/5 - 700/5 - 750/5 - 800/5 1000/5 - 1200/5 - 1250/5 | 0,2 - 0,5 0,5S 1-3 | 1-1,25-1,5 2,5-5-10 15-20-30 | ☎ |
| 150/1 - 200/1 - 250/1 - 300/1 - 400/1 500/1 - 600/1 - 700/1 - 750/1 - 800/1 1000/1 - 1200/1 - 1250/1 | 0,2 - 0,5 0,5S 1-3 | 1-1,25-1,5 2,5-5-10 15-20-30 | |

UN-530

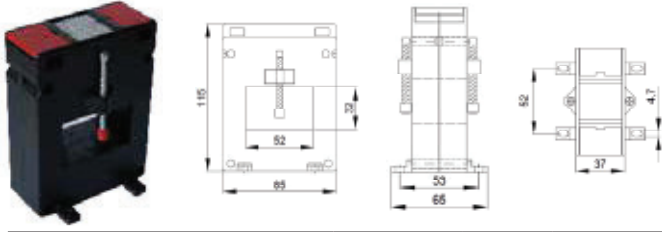

| Akım / Primacy / Secondary | Ölçme Sınıfı / | Güç (VA) | Birim Fiyat Unit Price (Adet/pcs) |
|---|--------------------------|------------------------------------|---|
| 200/5 - 250/5 - 300/5 - 400/5 - 500/5 600/5 - 700/5 - 750/5 - 800/5 - 1000/5 1200/5-1250/5-1500/5-1600/5-2000/5 | 0,2 - 0,5 0,5S 1-3 | 1-1,25-1,5 2,5-5-10 15-20-30 | ☎ |
| 200/1 - 250/1 - 300/1 - 400/1 - 500/1 600/1 - 700/1 - 750/1 - 800/1 - 1000/1 1200/1-1250/1-1500/1-1600/1-2000/1 | 0,2 - 0,5 0,5S 1-3 | 1-1,25-1,5 2,5-5-10 15-20-30 | |

UN-610

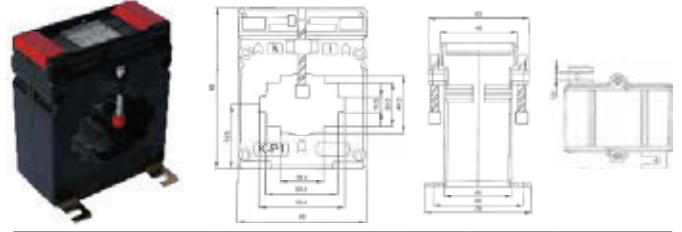

| Akım / Primacy / Secondary | Ölçme Sınıfı / | Güç (VA) | Birim Fiyat Unit Price (Adet/pcs) |
|--|---------------------------------|------------------------------------|---|
| 150/5 - 200/5 - 250/5 - 300/5 - 400/5 500/5 - 600/5 - 700/5 - 750/5 - 800/5 1000/5 - 1200/5 - 1250/5 | 0,2 - 0,2S 0,5 - 0,5S 1-3 | 1-1,25-1,5 2,5-5-10 15-20-30 | ☎ |
| 150/1 - 200/1 - 250/1 - 300/1 - 400/1 500/1 - 600/1 - 700/1 - 750/1 - 800/1 1000/1 - 1200/1 - 1250/1 | 0,2 - 0,5 0,5S 1-3 | 1-1,25-1,5 2,5-5-10 15-20-30 | |

UN-630

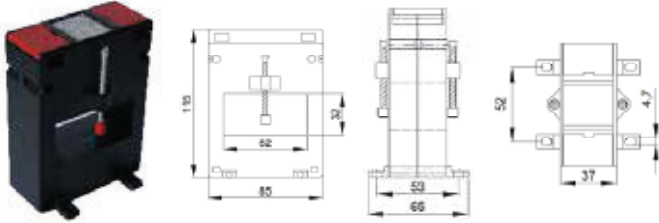

| Akım / Primacy / Secondary | Ölçme Sınıfı / | Güç (VA) | Birim Fiyat Unit Price (Adet/pcs) |
|---|---------------------------------|------------------------------------|---|
| 200/5 - 250/5 - 300/5 - 400/5 - 500/5 600/5 - 700/5 - 750/5 - 800/5 - 1000/5 1200/5-1250/5-1500/5-1600/5-2000/5 | 0,2 - 0,2S 0,5 - 0,5S 1-3 | 1-1,25-1,5 2,5-5-10 15-20-30 | ☎ |
| 200/1 - 250/1 - 300/1 - 400/1 - 500/1 600/1 - 700/1 - 750/1 - 800/1 - 1000/1 1200/1-1250/1-1500/1-1600/1-2000/1 | 0,2 - 0,2S 0,5 - 0,5S 1-3 | 1-1,25-1,5 2,5-5-10 15-20-30 | |

UN-130

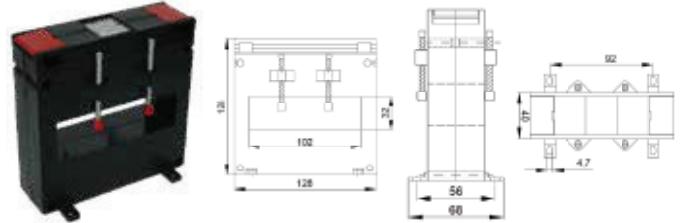

| Akım / Primacy / Secondary | Ölçme Sınıfı / | Güç (VA) | Birim Fiyat Unit Price (Adet/pcs) |
|--|---------------------------------|------------------------------------|---|
| 400/5 - 500/5 600/5 - 700/5 - 750/5 800/5 - 1000/5 1200/5 - 1250/5 - 1500/5 1600/5 - 2000/5 - 2500/5 - 3000/5 3200/5 - 4000 | 0,2 - 0,2S 0,5 - 0,5S 1-3 | 1-1,25-1,5 2,5-5-10 15-20-30 | ☎ |
| 150/1 - 200/1 - 250/1 - 300/1 - 400/1 500/1 - 600/1 - 700/1 - 750/1 - 800/1 1000/1 - 1200/1 - 1250/1 | 0,2 - 0,5 0,5S 1-3 | 1-1,25-1,5 2,5-5-10 15-20-30 | |

UN-150

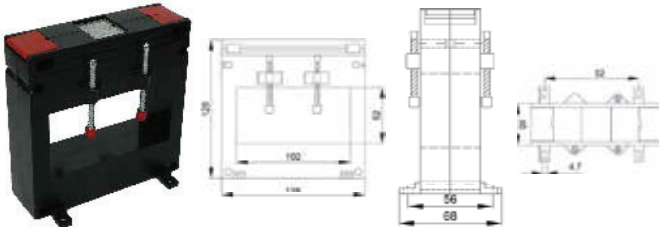

| Akım / Primacy / Secondary | Ölçme Sınıfı / | Güç (VA) | Birim Fiyat Unit Price (Adet/pcs) |
|--|---------------------------------|------------------------------------|---|
| 400/5 - 500/5 600/5 - 700/5 - 750/5 800/5 - 1000/5 1200/5 - 1250/5 - 1500/5 1600/5 - 2000/5 - 2500/5 - 3000/5 3200/5 - 4000 | 0,2 - 0,2S 0,5 - 0,5S 1-3 | 1-1,25-1,5 2,5-5-10 15-20-30 | ☎ |
| 150/1 - 200/1 - 250/1 - 300/1 - 400/1 500/1 - 600/1 - 700/1 - 750/1 - 800/1 1000/1 - 1200/1 - 1250/1 | 0,2 - 0,5 0,5S 1-3 | 1-1,25-1,5 2,5-5-10 15-20-30 | |

UN-125

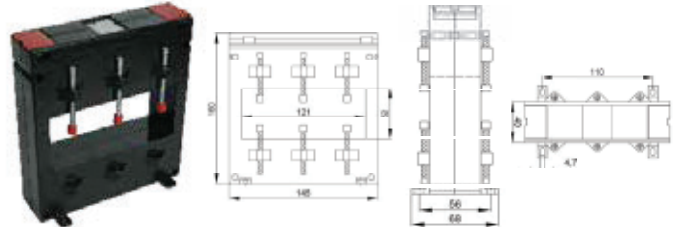

| Akım / Primacy / Secondary | Ölçme Sınıfı / | Güç (VA) | Birim Fiyat Unit Price (Adet/pcs) |
|--|---------------------------------|------------------------------------|---|
| 600/5 - 700/5 - 750/5 - 800/5 - 1000/5 1200/5 - 1250/5 - 1500/5 1600/5 2000/5 2500/5 - 3000/5 3200/5 4000/5 - 5000/5 - 6000/5 | 0,2 - 0,2S 0,5 - 0,5S 1-3 | 1-1,25-1,5 2,5-5-10 15-20-30 | ☎ |
| 600/1 - 700/1 - 750/1 - 800/1 - 1000/1 1200/1 - 1250/1 - 1500/1 1600/1 2000/1 - 2500/1 - 3000/1 3200/1 4000/1 - 5000/1 - 6000/1 | 0,2 - 0,2S 0,5 - 0,5S 1-3 | 1-1,25-1,5 2,5-5-10 15-20-30 | |

UN-127

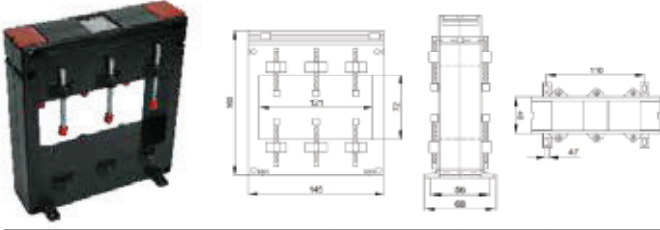

| Akım / Primacy / Secondary | Ölçme Sınıfı / | Güç (VA) | Birim Fiyat Unit Price (Adet/pcs) |
|--|--------------------------------|------------------------------------|---|
| 600/5 - 700/5 - 750/5 - 800/5 - 1000/5 1200/5 - 1250/5 - 1500/5 1600/5 2000/5 2500/5 - 3000/5 3200/5 4000/5 - 5000/5 - 6000/5 | 0,2 - 02S 0,5 - 0,5S 1-3 | 1-1,25-1,5 2,5-5-10 15-20-30 | ☎ |
| 600/1 - 700/1 - 750/1 - 800/1 - 1000/1 1200/1 - 1250/1 - 1500/1 1600/1 2000/1 - 2500/1 - 3000/1 3200/1 4000/1 - 5000/1 - 6000/1 | 0,2 - 02S 0,5 - 0,5S 1-3 | 1-1,25-1,5 2,5-5-10 15-20-30 | |

UA-23

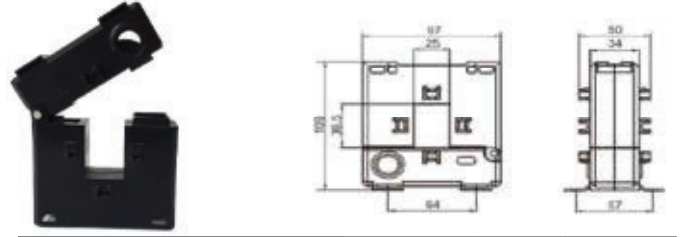

| Akım / Primacy / Secondary | Ölçme Sınıfı / | Güç (VA) | Birim Fiyat Unit Price (Adet/pcs) |
|---|----------------|---------------------------|---|
| 100/5 - 125/5 - 150/5 200/5 - 250/5 - 300/5 400/5 | 0,5 - 1 - 3 | 1,25-1,5 2,5-3,75 5 | ☎ |
| 100/1 - 125/1 - 150/1 200/1 - 250/1 - 300/1 400/1 | 0,5 - 1 - 3 | 1,25-1,5 2,5-3,75 5 | |

UA-58

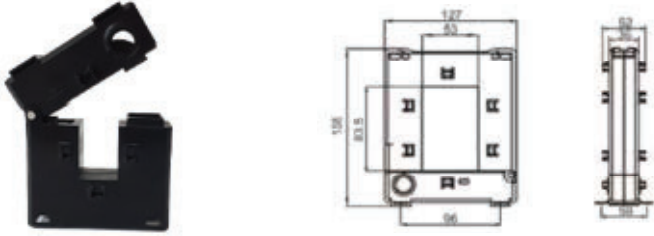

| Akım / Primacy / Secondary | Ölçme Sınıfı / | Güç (VA) | Birim Fiyat Unit Price (Adet/pcs) |
|---|----------------|---------------------------------|---|
| 250/5 - 300/5 - 400/5 - 500/5 600/5 700/5 - 750/5 - 800/5 1000/5 1200/5 | 0,5 1-3 | 1-1,5-2,5 5 - 7,5 10 - 15 | ☎ |
| 250/1 - 300/1 - 400/1 - 500/1 600/1 700/1 - 750/1 - 800/1 1000/1 - 1200/1 | 0,5 1-3 | 1-1,5-2,5 5 - 7,5 10 - 15 | |

UA-812

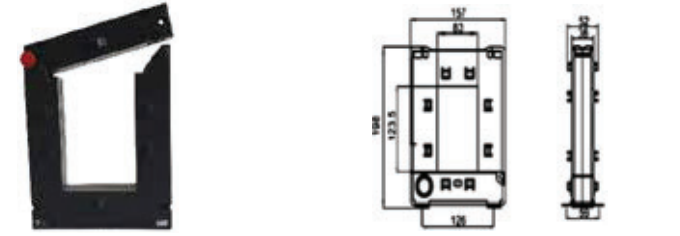

| Akım / Primacy / Secondary | Ölçme Sınıfı / | Güç (VA) | Birim Fiyat Unit Price (Adet/pcs) |
|--|----------------|------------------------------|---|
| 400/5 - 500/5 600/5 - 700/5 - 750/5 800/5 - 1000/5 1200/5 - 1250/5 - 1500/5 1600/5 - 2000/5 - 2500/5 - 3000/5 3200/5 - 4000/5 | 0,5 1-3 | 1,5 - 2,5 5-10 15 - 30 | ☎ |
| 400/1 - 500/1 - 600/1 - 700/1 - 750/1 800/1-1000/1-1200/1-1250/1-1500/1 1600/1 - 2000/1 - 2500/1 - 3000/1 3200/1 - 4000/1 | 0,5 1-3 | 1,5 - 2,5 5-10 15 - 30 | |

UNS-17

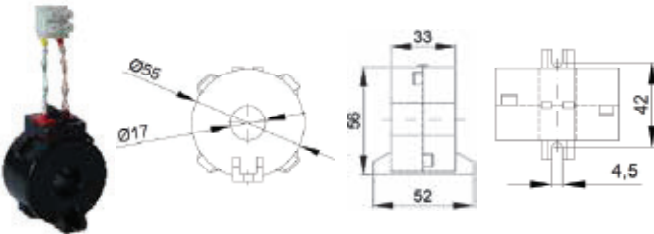

| Akım / Primacy / Secondary | Ölçme Sınıfı / | Güç (VA) | Birim Fiyat Unit Price (Adet/pcs) |
|--|----------------|-----------------|---|
| 30/5 - 40/5 - 50/5 - 60/5 - 75/5 80/5 - 100/5 - 125/5 - 150/5 | 0,5 1-3 | 1,5 2,5 5 | ☎ |
| 30/1 - 40/1 - 50/1 - 60/1 - 75/1 80/1 - 100/1 - 125/1 - 150/1 | 0,5 1-3 | 1,5 2,5 5 | |

UNS-30

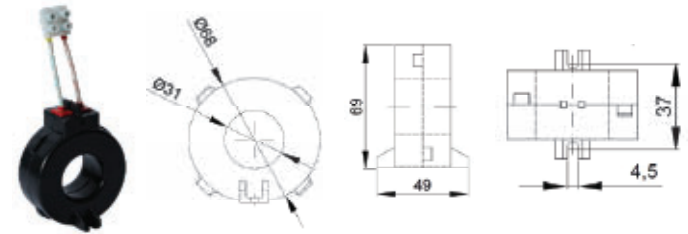

| Akım / Primacy / Secondary | Ölçme Sınıfı / | Güç (VA) | Birim Fiyat Unit Price (Adet/pcs) |
|---|----------------|---------------------------|---|
| 150/5 - 200/5 - 250/5 - 300/5 400/5 - 500/5 - 600/5 - 700/5 750/5 - 800/5 | 0,5 1-3 | 1,5 - 2,5 5 - 10 15 | ☎ |
| 150/1 - 200/1 - 250/1 - 300/1 400/1 - 500/1 - 600/1 - 700/1 750/1 - 800/1 | 0,5 1-3 | 1,5 - 2,5 5 - 10 15 | |

UNS-40

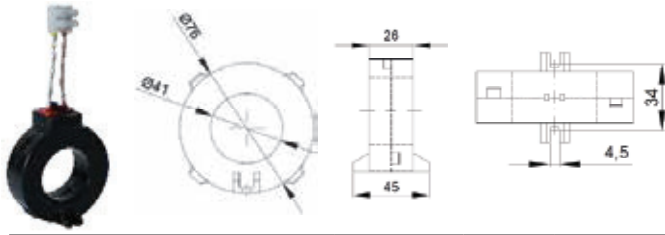

| Akım / Primacy / Secondary | Ölçme Sınıfı / | Güç (VA) | Birim Fiyat Unit Price (Adet/pcs) |
|---|----------------|---------------------------|---|
| 150/5 - 200/5 - 250/5 - 300/5 400/5 - 500/5 - 600/5 - 700/5 750/5 - 800/5 | 0,5 1 - 3 | 1,5 - 2,5 5 - 10 15 | |
| 150/1 - 200/1 - 250/1 - 300/1 400/1 - 500/1 - 600/1 - 700/1 750/1 - 800/1 | 0,5 1 - 3 | 1,5 - 2,5 5 - 10 15 | |

UNS-60

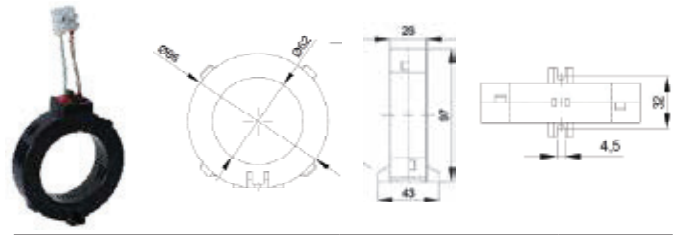

| Akım / Primacy / Secondary | Ölçme Sınıfı / | Güç (VA) | Birim Fiyat Unit Price (Adet/pcs) |
|---|----------------|---------------------------|---|
| 400/5 - 500/5 600/5 - 700/5 - 750/5 800/5 - 1000/5 1200/5 - 1250/5 | 0,5 1 - 3 | 1,5 - 2,5 5 - 10 15 | |
| 400/1 - 500/1 - 600/1 - 700/1 - 750/1 800/1-1000/1-1200/1-1250/1 | 0,5 1 - 3 | 1,5 - 2,5 5 - 10 15 | |

UNS-80

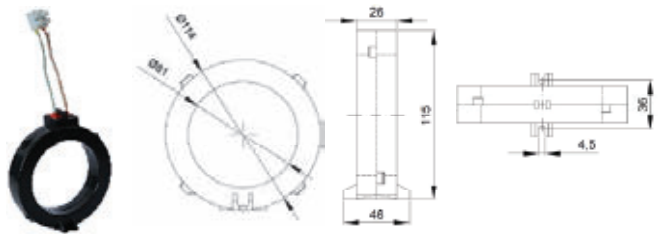

| Akım / Primacy / Secondary | Ölçme Sınıfı / | Güç (VA) | Birim Fiyat Unit Price (Adet/pcs) |
|--|----------------|---------------|---|
| 500/5 - 600/5 - 700/5 - 750/5 800/5 - 1000/5 - 1200/5 1250/5 - 1500/5 - 1600/5 | 0,5 1 - 3 | 5 10 15 | |
| 500/1 - 600/1 - 700/1 - 750/1 800/1 - 1000/1 - 1200/1 1250/1 - 1500/1 - 1600/1 | 0,5 1 - 3 | 5 10 15 | |

UNS-100

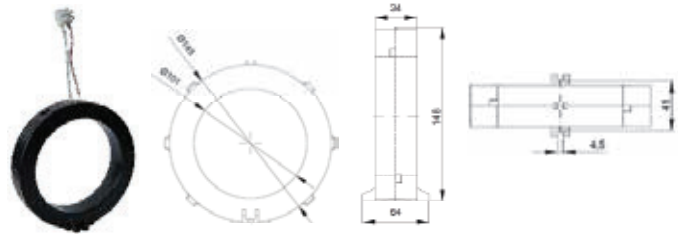

| Akım / Primacy / Secondary | Ölçme Sınıfı / | Güç (VA) | Birim Fiyat Unit Price (Adet/pcs) |
|---|----------------|---------------|---|
| 800/5 - 1000/5 - 1200/5 - 1250/5 1500/5 - 1600/5 - 2000/5 - 2500/5 3000/5 - 3200/5 - 4000/5 | 0,5 1 - 3 | 5 10 15 | |
| 800/1 - 1000/1 - 1200/1 - 1250/1 1500/1 - 1600/1 - 2000/1 - 2500/1 3000/1 - 3200/1 - 4000/1 | 0,5 1 - 3 | 5 10 15 | |

UNS-120

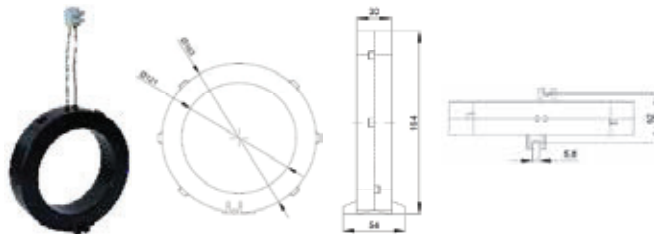

| Akım / Primacy / Secondary | Ölçme Sınıfı / | Güç (VA) | Birim Fiyat Unit Price (Adet/pcs) |
|---|----------------|------------------------------------|---|
| 1000/5 - 1200/5 - 1250/5 - 1500/5 1600/5 - 2000/5 - 2500/5 3000/5 3200/5 4000/5 | 0,5 1 - 3 | 5-10 20-30 | |
| 1000/1 - 1200/1 - 1250/1 - 1500/1 1600/1 - 2000/1 - 2500/1 3000/1 - 3200/1 - 4000/1 | 0,5 1 - 3 | 1-1,25-1,5 2,5-5-10 15-20-30 | |

Silindirik Kartuş Sigorta Yuvaları (10x38)
 Cylindrical Cartridge Fuse Holders (10x38)

| Kod / Code | Cinsi / Type | Kutu Adedi / Box Qty | Adet Fiyat Unit Price (Adet/pcs) |
|------------------|-------------------------------|----------------------|----------------------------------|
| İRTU - KSY011038 | 1 Kutup 10X38 1 Pole 10X38 | 10 | |
| İRTU - KSY021038 | 2 Kutup 10X38 2 Pole 10X38 | 8 | |
| İRTU - KSY031038 | 3 Kutup 10X38 3 Pole 10X38 | 6 | |
| İRTU - KSY041038 | 4 Kutup 10X38 4 Pole 10X38 | 4 | |
| İRTU-KSY051038 | 1 Kutup 10X38 1 Pole 10X38 | 10 | |

Silindirik Kartuş Sigortaları (10x38)
 Cylindrical Cartridge Fuses (10x38)

| Kod / Code | Cinsi / Type | Kutu Adedi / Box Qty | Adet Fiyat Unit Price (Adet/pcs) |
|----------------|--------------|----------------------|----------------------------------|
| İRTU-KS1038005 | 10X38 0,5A | 10 | |
| İRTU-KS1038010 | 10X38 1A | 10 | |
| İRTU-KS1038020 | 10X38 2A | 10 | |
| İRTU-KS1038040 | 10X38 4A | 10 | |
| İRTU-KS1038060 | 10X38 6A | 10 | |
| İRTU-KS1038080 | 10X38 8A | 10 | |
| İRTU-KS1038100 | 10X38 10A | 10 | |
| İRTU-KS1038120 | 10X38 12A | 10 | |
| İRTU-KS1038160 | 10X38 16A | 10 | |
| İRTU-KS1038200 | 10X38 20A | 10 | |
| İRTU-KS1038250 | 10X38 25A | 10 | |
| İRTU-KS1038320 | 10X38 32A | 10 | |

Silindirik Kartuş Sigorta Yuvaları (14x51)
 Cylindrical Cartridge Fuse Holders (14x51)

| Kod / Code | Cinsi / Type | Kutu Adedi / Box Qty | Adet Fiyat Unit Price (Adet/pcs) |
|------------------|-------------------------------|----------------------|----------------------------------|
| İRTU - KSY011451 | 1 Kutup 14X51 1 Pole 14X51 | 10 | |
| İRTU - KSY021451 | 2 Kutup 14X51 2 Pole 14X51 | 8 | |
| İRTU - KSY031451 | 3 Kutup 14X51 3 Pole 14X51 | 6 | |

Silindirik Kartuş Sigortaları (14x51)
 Cylindrical Cartridge Fuses (14x51)

| Kod / Code | Cinsi / Type | Kutu Adedi / Box Qty | Adet Fiyat Unit Price (Adet/pcs) |
|---------------|--------------|----------------------|----------------------------------|
| İRTU-KS145106 | 14X51 6A | 10 | |
| İRTU-KS145108 | 14X51 8A | 10 | |
| İRTU-KS145110 | 14X51 10A | 10 | |
| İRTU-KS145112 | 14X51 12A | 10 | |
| İRTU-KS145116 | 14X51 16A | 10 | |
| İRTU-KS145120 | 14X51 20A | 10 | |
| İRTU-KS145125 | 14X51 25A | 10 | |
| İRTU-KS145132 | 14X51 32A | 10 | |
| İRTU-KS145140 | 14X51 40A | 10 | |
| İRTU-KS145150 | 14X51 50A | 10 | |

Silindirik Kartuş Sigorta Yuvaları (22x58)
 Cylindrical Cartridge Fuse Holders (22x58)

| Kod / Code | Cinsi / Type | Kutu Adedi / Box Qty | Adet Fiyat Unit Price (Adet/pcs) |
|------------------|-------------------------------|----------------------|----------------------------------|
| İRTU - KSY012258 | 1 Kutup 22X58 1 Pole 22X58 | 10 | |
| İRTU - KSY022258 | 2 Kutup 22X58 2 Pole 22X58 | 8 | |
| İRTU - KSY032258 | 3 Kutup 22X58 3 Pole 22X58 | 6 | |

Silindirik Kartuş Sigortaları (22x58)
 Cylindrical Cartridge Fuses (22x58)

| Kod / Code | Cinsi / Type | Kutu Adedi / Box Qty | Adet Fiyat Unit Price (Adet/pcs) |
|----------------|--------------|----------------------|----------------------------------|
| İRTU-KS2258016 | 22X58 16A | 10 | |
| İRTU-KS2258020 | 22X58 20A | 10 | |
| İRTU-KS2258025 | 22X58 25A | 10 | |
| İRTU-KS2258032 | 22X58 23A | 10 | |
| İRTU-KS2258040 | 22X58 40A | 10 | |
| İRTU-KS2258050 | 22X58 50A | 10 | |
| İRTU-KS2258063 | 22X58 63A | 10 | |
| İRTU-KS2258080 | 22X58 80A | 10 | |
| İRTU-KS2258100 | 22X58 100A | 10 | |
| İRTU-KS2258125 | 22X58 125A | 10 | |

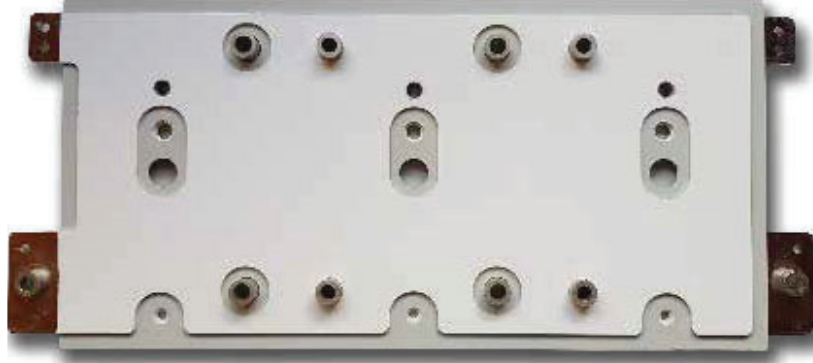

DC Lamine busbar, elektrik ve elektronik ürünün güç cihazlarını bağlamak için uygulanır. Çok katmanlı bir iletken ve yalıtkan kompozit yapı ürünleridir. Lamine busbar kullanılan sistemlerde maliyetleri düşürür. Kapasitansı artırır ve endüktansı azaltır. Kablolama hatalarının önüne geçmeye yardımcı olur. Ayrıca, busbarların fiziksel yapısında ve mekanik tasarımında benzersiz kolaylıklar sağlar. Busbarlar projeye göre özel üretim yapılmakta ve bu sayede sistemin temel bir parçası olarak hareket etmektedir.

DC Laminated Busbar is applied to connect the power devices of the electrical and electronic product. It is a multilayer conductor and insulator composite structure products. Laminated Busbars reduce manufacturing costs, eliminate wiring errors, increase capacitance and lower inductance. The structure of busbars offers special features in mechanical design. They are produced specifically for the project and thus act as a primary element of the system.

Projeye göre özel üretim yapılmaktadır.

Manufacturing size can be done for clients specifically

PROFESYONELİZ VE SİZİN İÇİN EN İYİ ÇÖZÜMLERİ ÜRETİYORUZ

Üretim Tecrübesi



Çözüm Odaklılık



Güvenilirlik



Uluslararası
Kalite
Standartları



Yenilikçi Bakış Açısı



Müşteri Odaklılık





ISO 9001:2015
Sertifikası



CE Sertifikası



Marka Tescil
Sertifikası

Neden Bizi Tercih Etmelisiniz?

Tecrübeliyiz;

1995 Yılından beri sektörde tecrübemiz ve uzman ekimizle birlikte hizmet veriyoruz.

Müşteri Odaklı Yaklaşım;

Müşterilerimizin beklentilerini daima göz önünde tutuyor, iletişime ve devamlılığı önemsiyoruz.

Çözüm Odaklı Bakış Açısına Sahibiz;

Üretici kimliğimiz ile sektörün ve müşterilerimizin ihtiyaçlarını karşılayabilecek çözümler sunuyoruz.

Önceliğimiz Kalite;

Kuruluşumuzdan bu yana, ürün ve hizmet kalitemizle sektörde fark yaratıyoruz.

Standartlarımızı Yüksek Tutuyoruz;

Firma ve ürünlerimiz ile ilgili gerekli belgelendirmelere sahibiz.

Yenilikçi Bakış Açısına Sahibiz;

Faaliyetlerimiz ile ilgili çağın ve sektörün gerektirdiği yenilik ve iyileştirmeleri uygulamayı prensip ediniyoruz.



IRTU ELEKTROMEKANİK SAN. ve TİC. LTD. ŞTİ.

NETSA
Elektromekanik San. Tic. Ltd. Şti.



+90 (216) 487 54 65 (pbx)



irtu@irtugroup.com.tr



+90 (216) 487 54 45



www.irtugroup.com.tr



Aydınlı, Aydınlı - İstanbul Ay OSB, Gazi Blv. No:48,
34956 Tuzla/İstanbul